



Figure **argsinh1** from the Moiré Demonstration Kit
accompanying the book: *The Theory of the Moiré Phenomenon*
by I. Amidror, published by Kluwer Academic Publishers, 2000.



Figure **argsinh2** from the Moiré Demonstration Kit
accompanying the book: *The Theory of the Moiré Phenomenon*
by I. Amidror, published by Kluwer Academic Publishers, 2000.

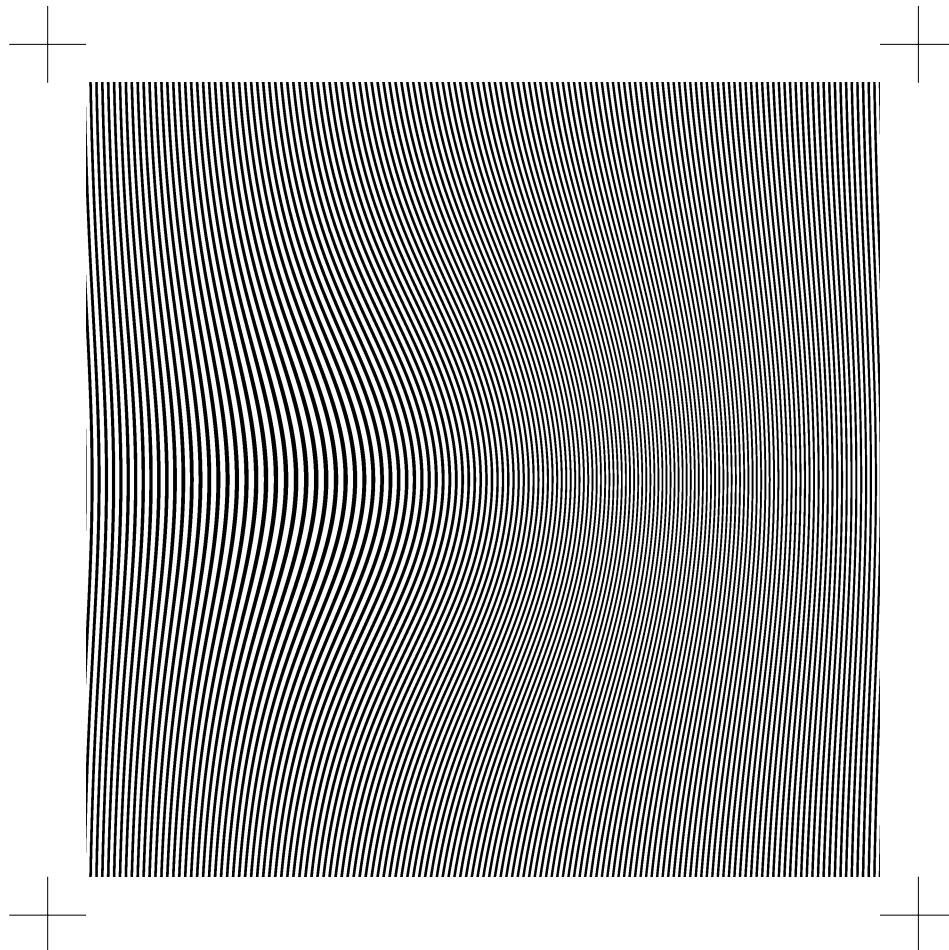

Figure **bell** from the Moiré Demonstration Kit
accompanying the book: *The Theory of the Moiré Phenomenon*
by I. Amidror, published by Kluwer Academic Publishers, 1999.

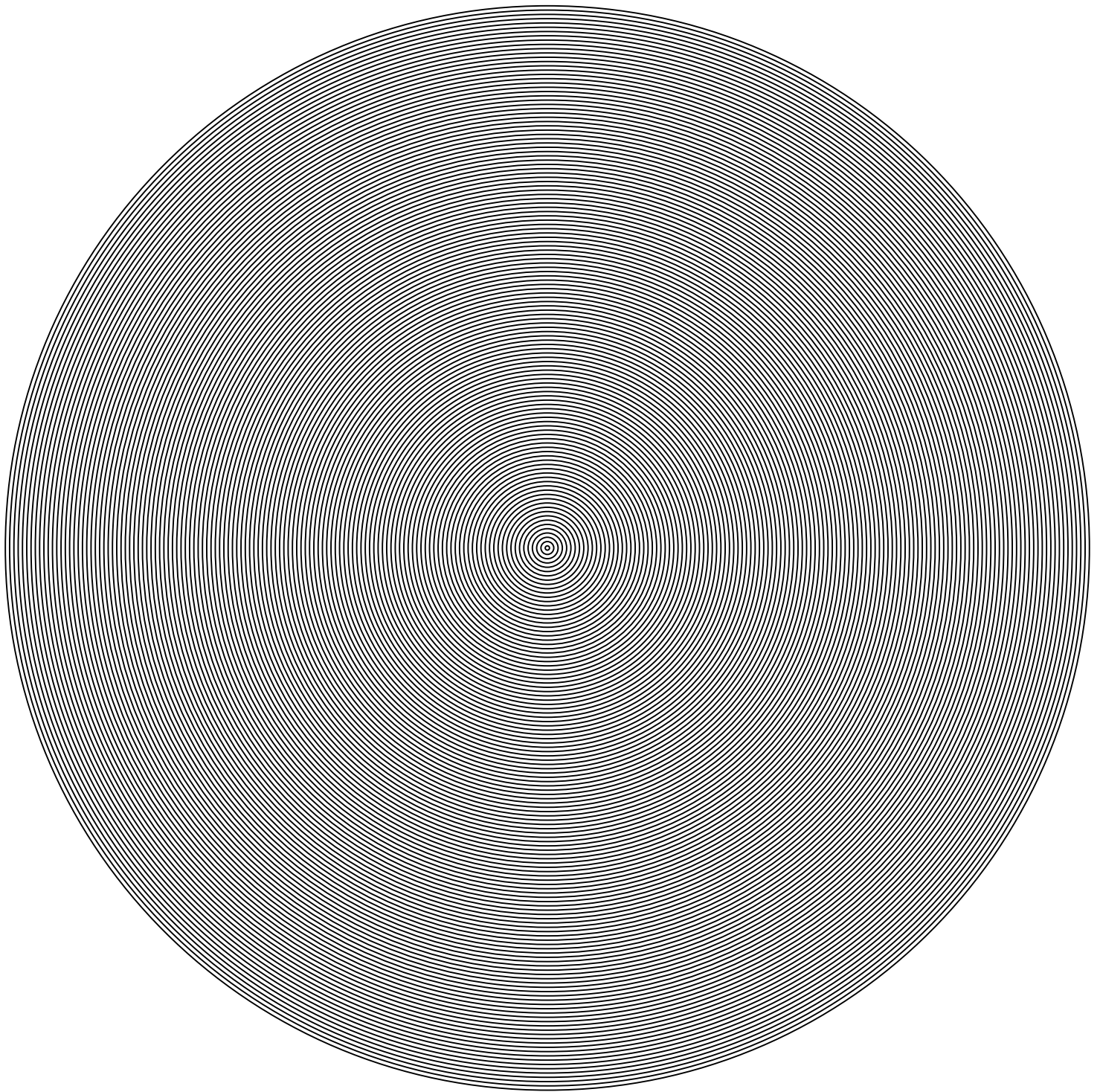

Figure **circ1** from the Moiré Demonstration Kit
accompanying the book: *The Theory of the Moiré Phenomenon*
by I. Amidror, published by Kluwer Academic Publishers, 1999.

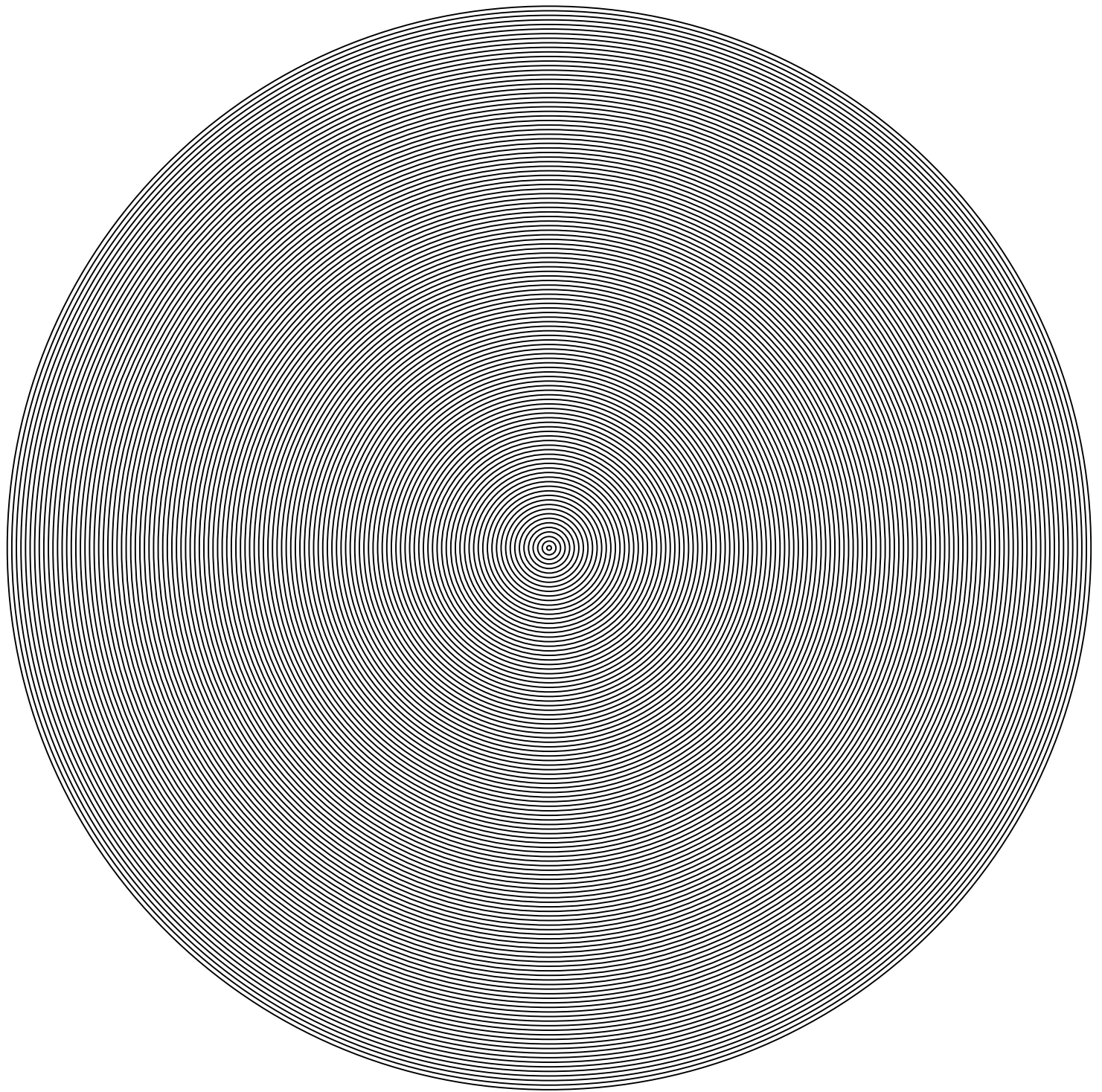

Figure **circ2** from the Moiré Demonstration Kit
accompanying the book: *The Theory of the Moiré Phenomenon*
by I. Amidror, published by Kluwer Academic Publishers, 1999.

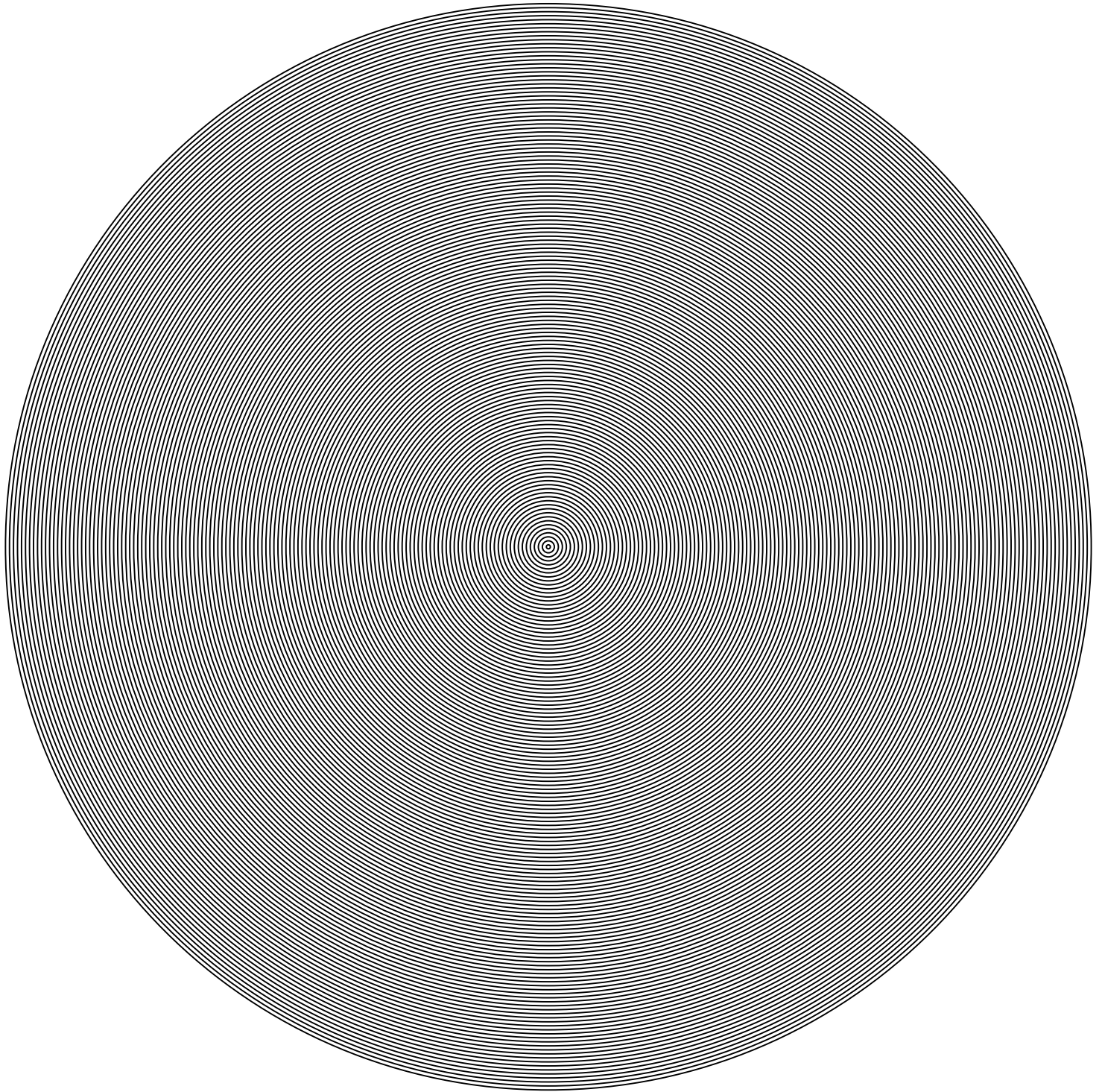

Figure **circ3** from the Moiré Demonstration Kit
accompanying the book: *The Theory of the Moiré Phenomenon*
by I. Amidror, published by Kluwer Academic Publishers, 1999.

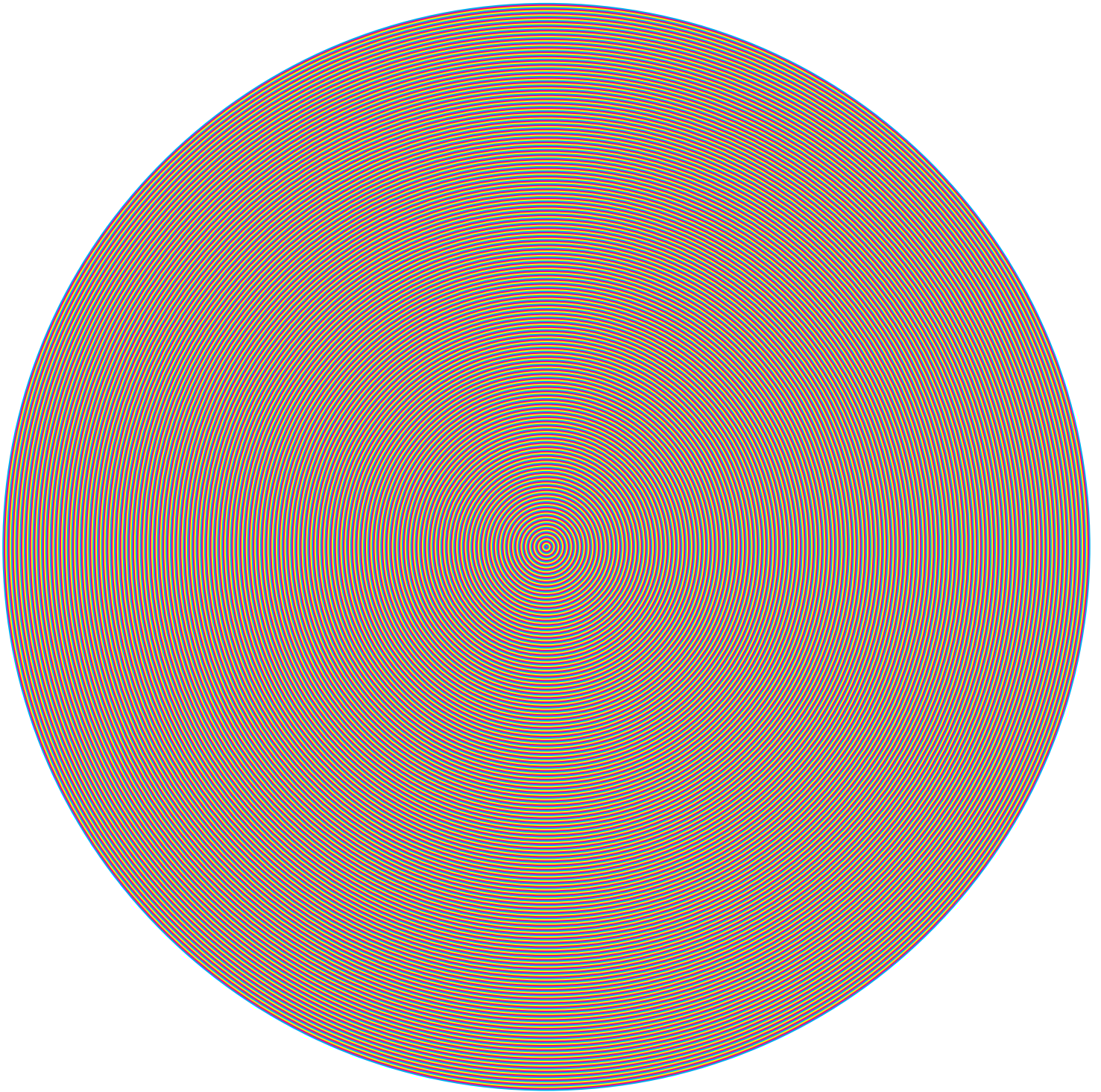

Figure **circmy** from the Moiré Demonstration Kit
accompanying the book: *The Theory of the Moiré Phenomenon*
by I. Amidror, published by Kluwer Academic Publishers, 1999.

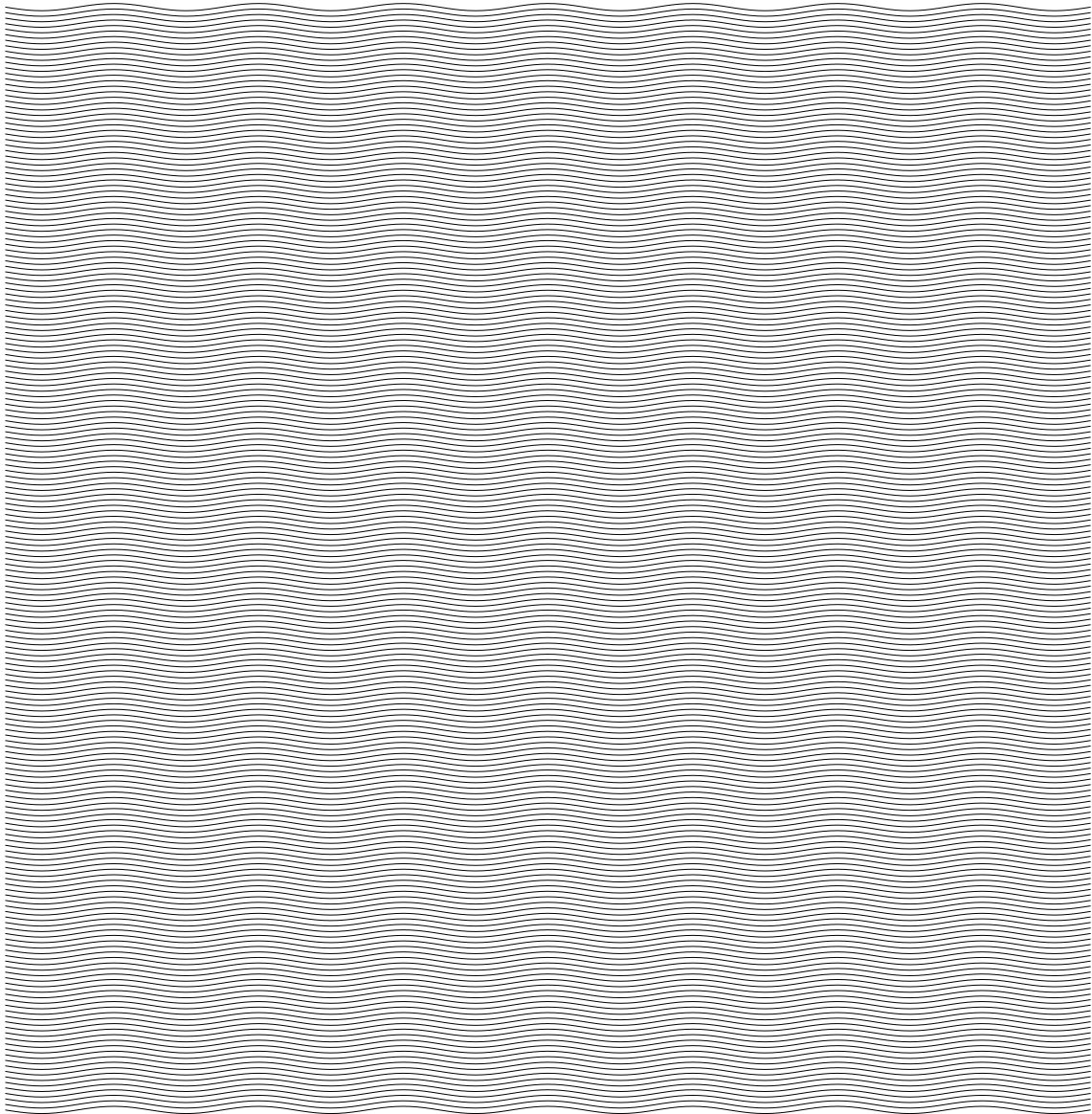

Figure **cos1** from the Moiré Demonstration Kit
accompanying the book: *The Theory of the Moiré Phenomenon*
by I. Amidror, published by Kluwer Academic Publishers, 1999.

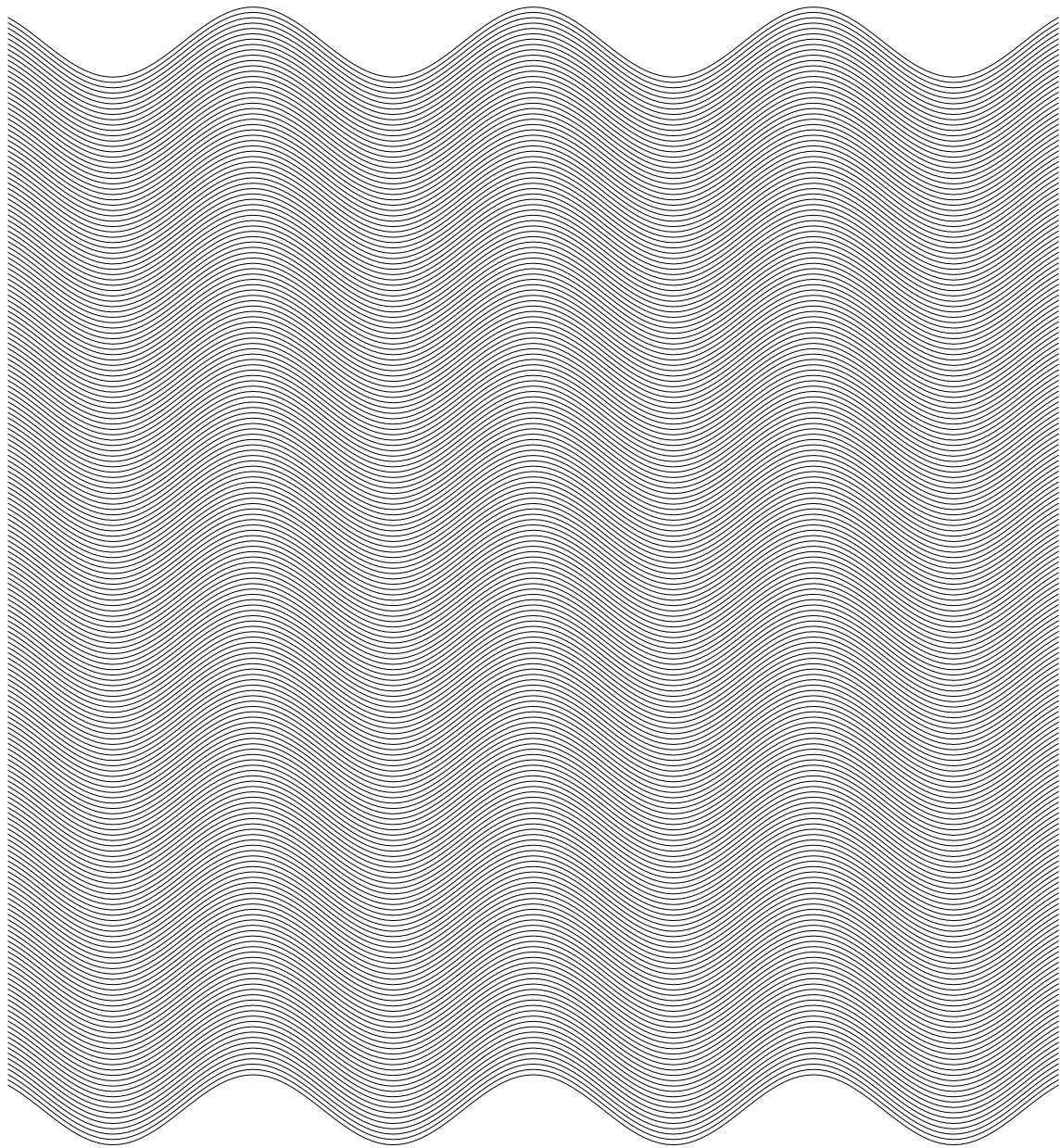

Figure **cos²** from the Moiré Demonstration Kit
accompanying the book: *The Theory of the Moiré Phenomenon*
by I. Amidror, published by Kluwer Academic Publishers, 1999.

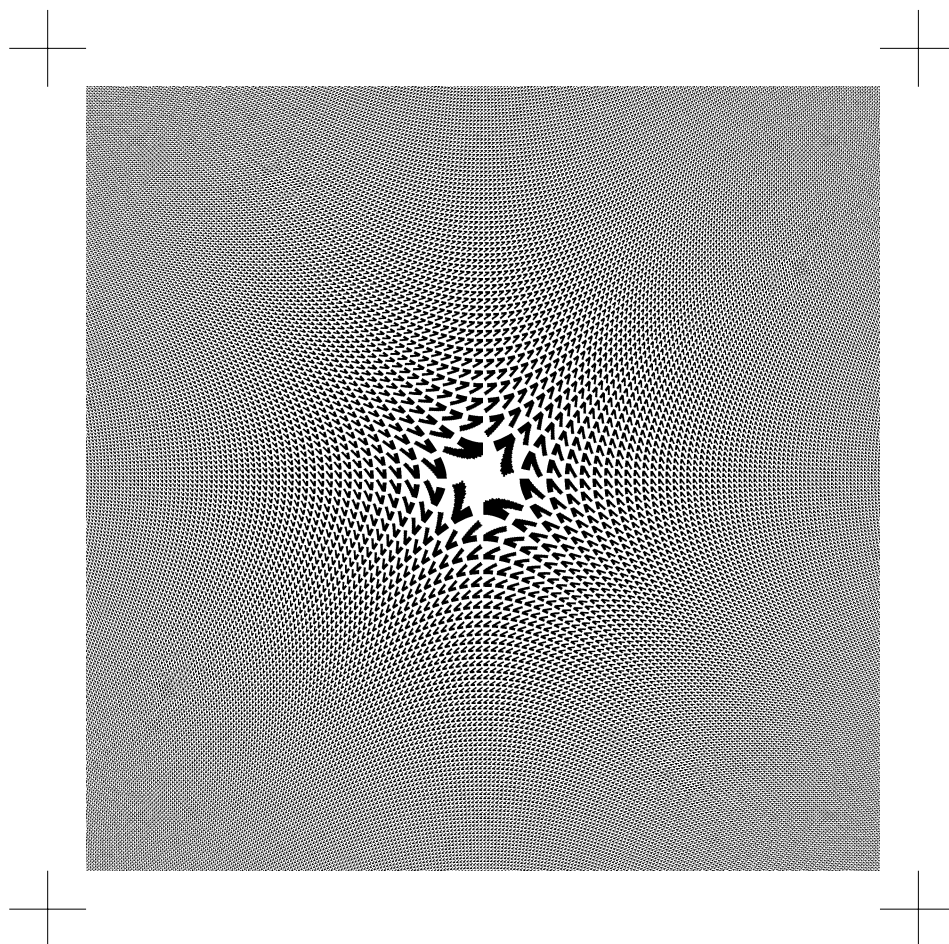

Figure **crvdscr1** from the Moiré Demonstration Kit accompanying the book: *The Theory of the Moiré Phenomenon* by I. Amidror, published by Kluwer Academic Publishers, 1999.

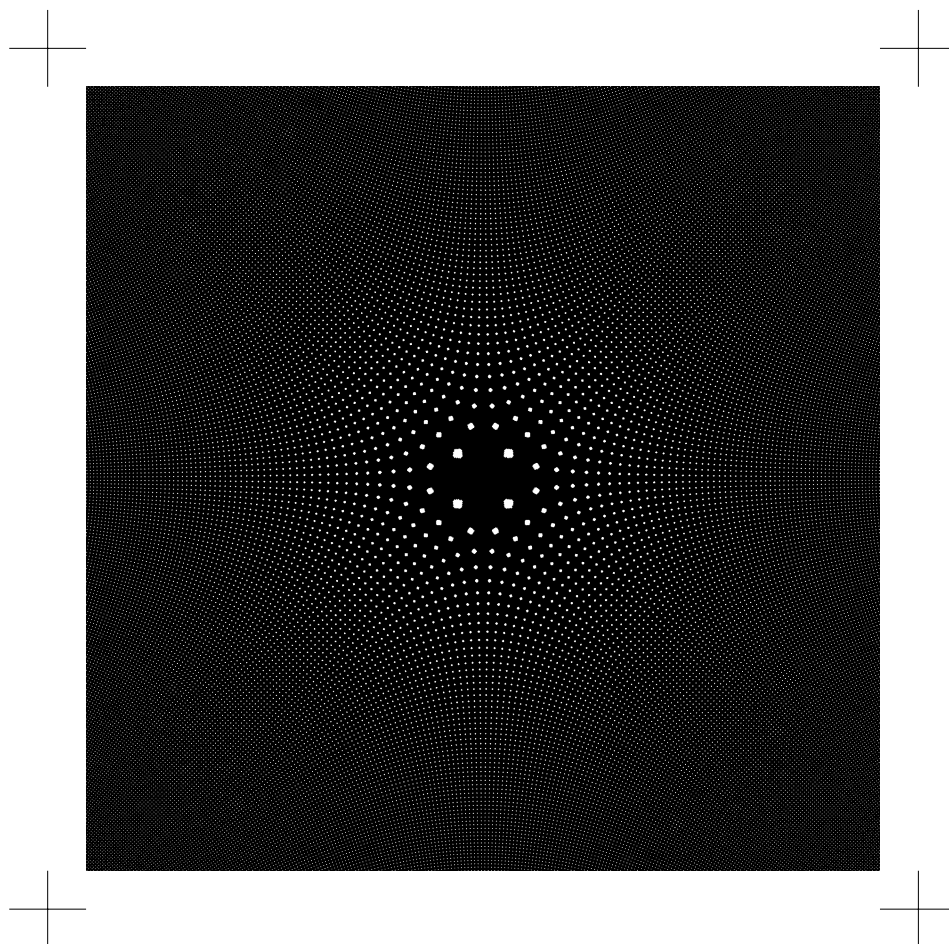

Figure **crvdscr2** from the Moiré Demonstration Kit
accompanying the book: *The Theory of the Moiré Phenomenon*
by I. Amidror, published by Kluwer Academic Publishers, 1999.

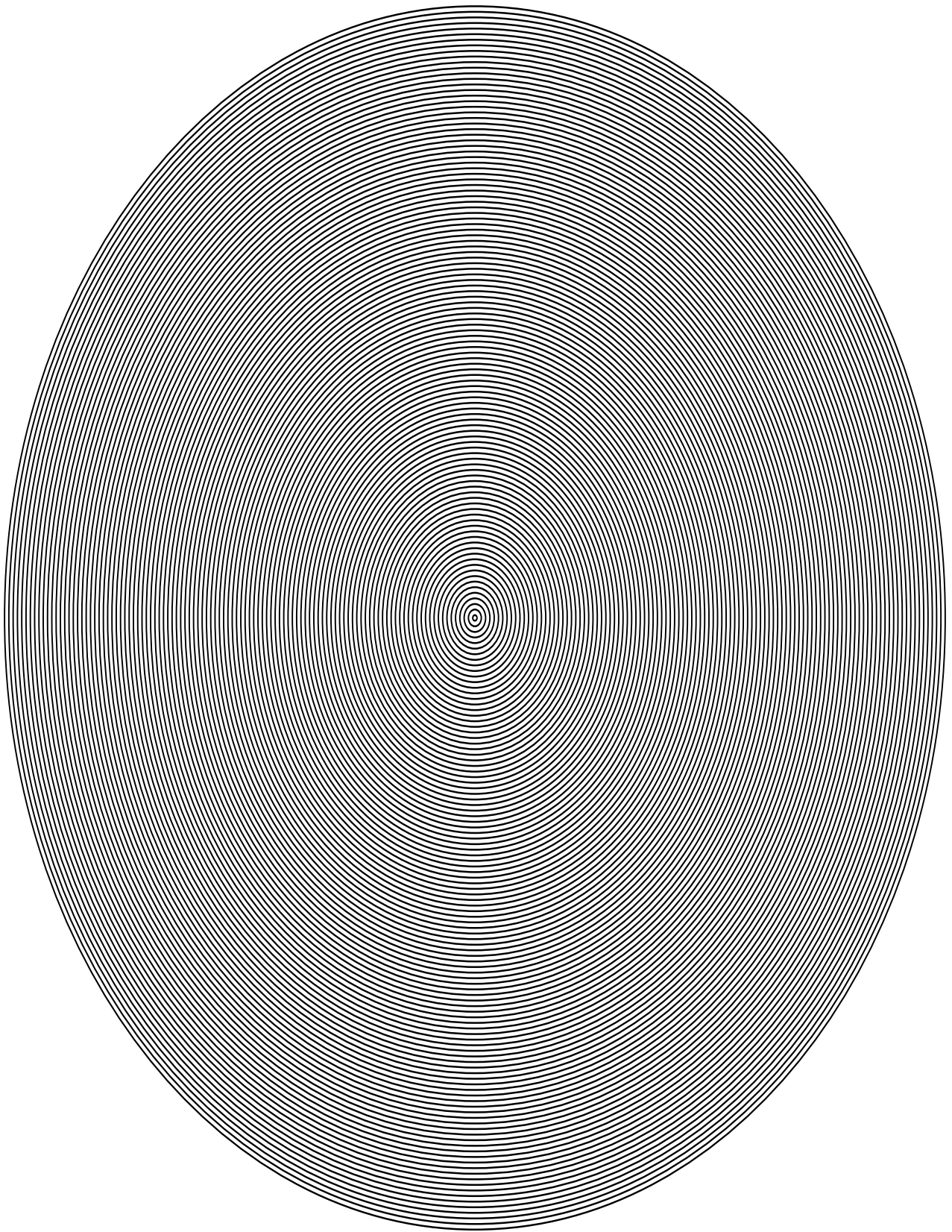

Figure **ellipse** from the Moiré Demonstration Kit
accompanying the book: *The Theory of the Moiré Phenomenon*
by I. Amidror, published by Kluwer Academic Publishers, 1999.

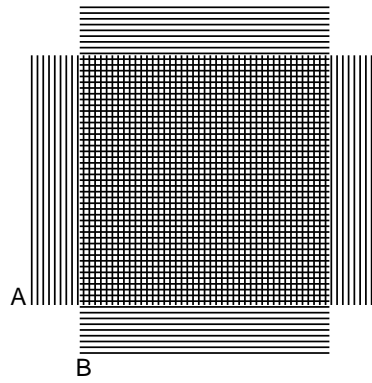

Figure 2.10(a) from the book: *The Theory of the Moiré Phenomenon*
by I. Amidror, published by Kluwer Academic Publishers, 1999.

(First layer only.)

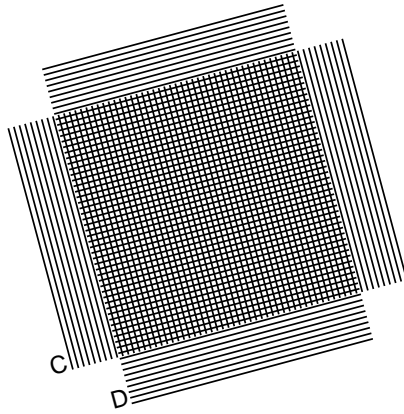

Figure 2.10(a) from the book: *The Theory of the Moiré Phenomenon*
by I. Amidror, published by Kluwer Academic Publishers, 1999.

(Second layer only.)

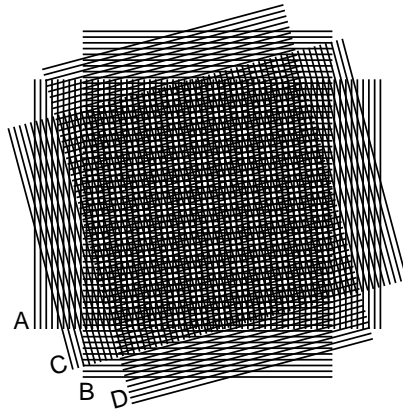

Figure 2.10(a) from the book: *The Theory of the Moiré Phenomenon* by I. Amidror, published by Kluwer Academic Publishers, 1999.

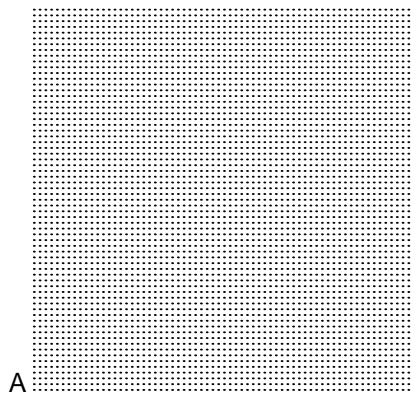

Figure 2.13(a) from the book: *The Theory of the Moiré Phenomenon*
by I. Amidror, published by Kluwer Academic Publishers, 1999.

(First layer only.)

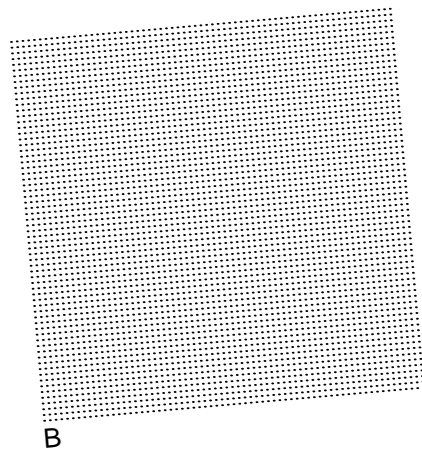

Figure 2.13(a) from the book: *The Theory of the Moiré Phenomenon*
by I. Amidror, published by Kluwer Academic Publishers, 1999.

(Second layer only.)

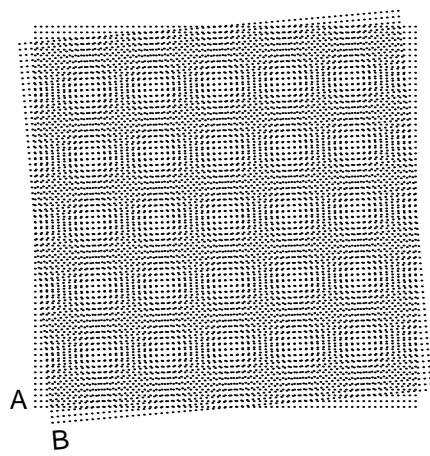

Figure 2.13(a) from the book: *The Theory of the Moiré Phenomenon*
by I. Amidror, published by Kluwer Academic Publishers, 1999.

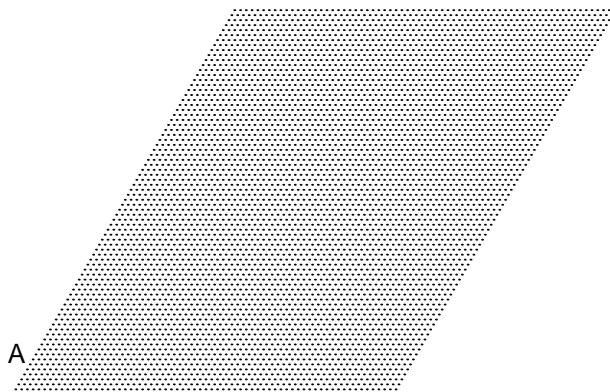

Figure 2.13(b) from the book: *The Theory of the Moiré Phenomenon*
by I. Amidror, published by Kluwer Academic Publishers, 1999.

(First layer only.)

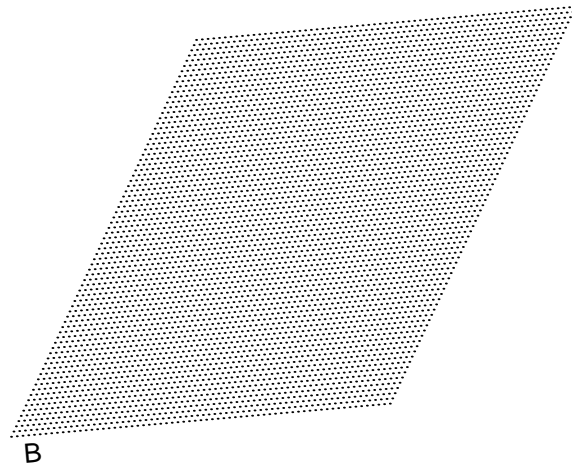

Figure 2.13(b) from the book: *The Theory of the Moiré Phenomenon*
by I. Amidror, published by Kluwer Academic Publishers, 1999.

(Second layer only.)

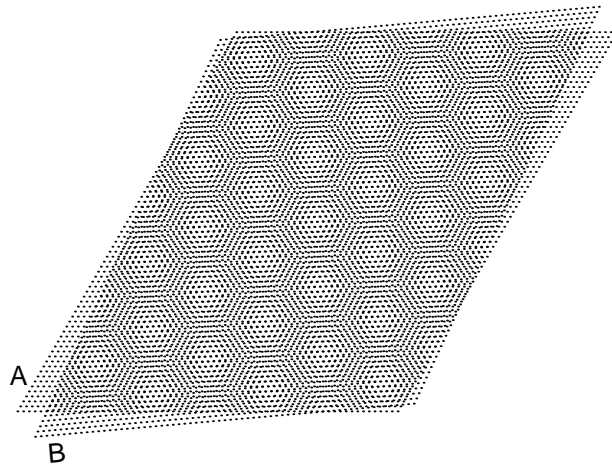
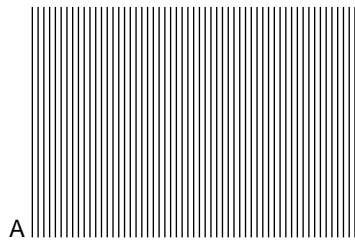

Figure 2.13(b) from the book: *The Theory of the Moiré Phenomenon*
by I. Amidror, published by Kluwer Academic Publishers, 1999.



(e)

Figure 2.8(e) from the book: *The Theory of the Moiré Phenomenon*
by I. Amidror, published by Kluwer Academic Publishers, 1999.

(First layer only.)

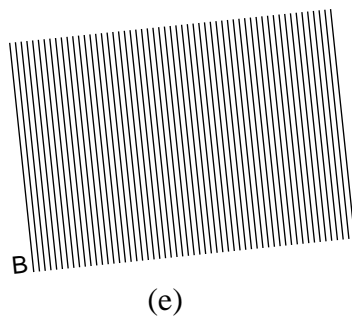

Figure 2.8(e) from the book: *The Theory of the Moiré Phenomenon*
by I. Amidror, published by Kluwer Academic Publishers, 1999.

(Second layer only.)

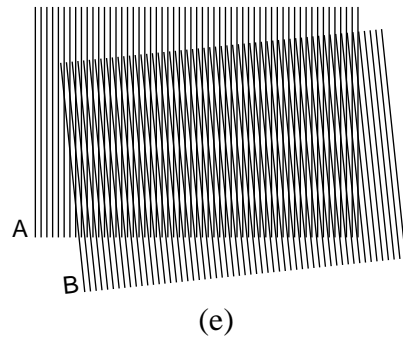
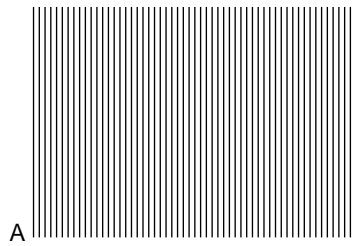

Figure 2.8(e) from the book: *The Theory of the Moiré Phenomenon*
by I. Amidror, published by Kluwer Academic Publishers, 1999.



(h)

Figure 2.8(h) from the book: *The Theory of the Moiré Phenomenon*
by I. Amidror, published by Kluwer Academic Publishers, 1999.

(First layer only.)



(h)

Figure 2.8(h) from the book: *The Theory of the Moiré Phenomenon*
by I. Amidror, published by Kluwer Academic Publishers, 1999.

(Second layer only.)

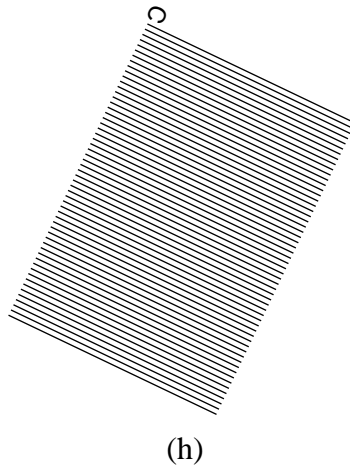

Figure 2.8(h) from the book: *The Theory of the Moiré Phenomenon*
by I. Amidror, published by Kluwer Academic Publishers, 1999.

(Third layer only.)

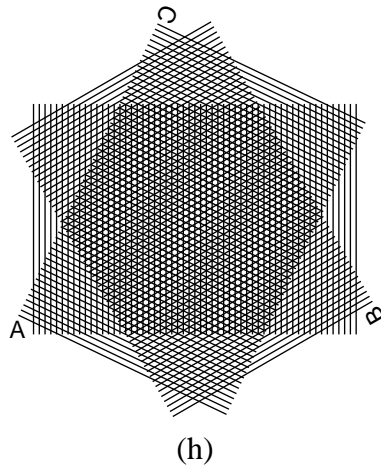

Figure 2.8(h) from the book: *The Theory of the Moiré Phenomenon*
by I. Amidror, published by Kluwer Academic Publishers, 1999.

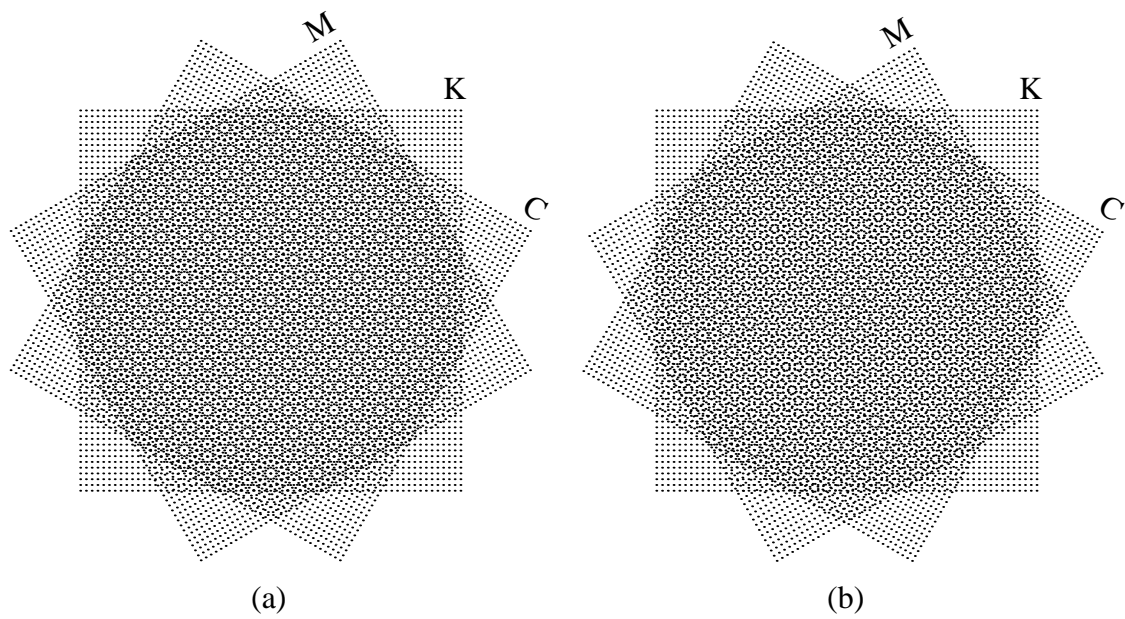

Figure 3.1 from the book: *The Theory of the Moiré Phenomenon* by I. Amidror, published by Kluwer Academic Publishers, 1999.

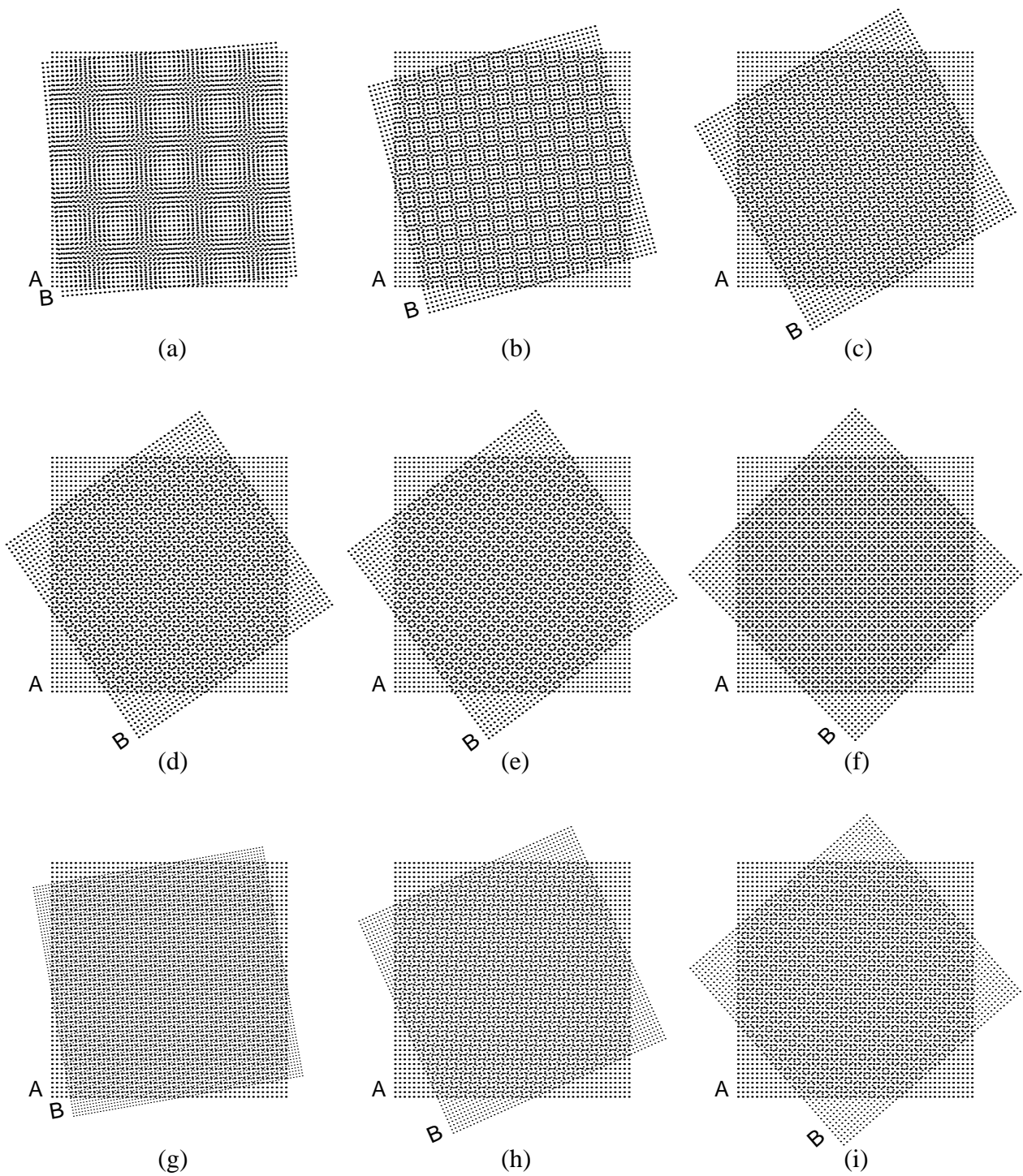
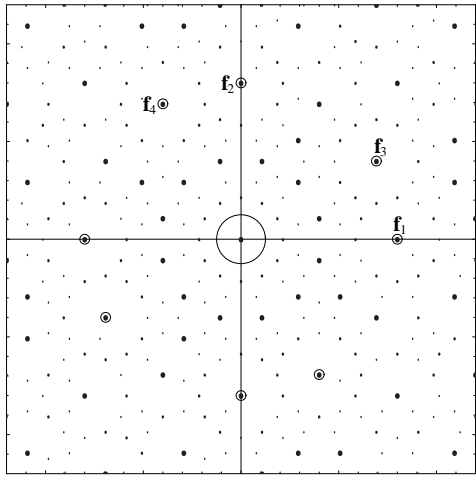
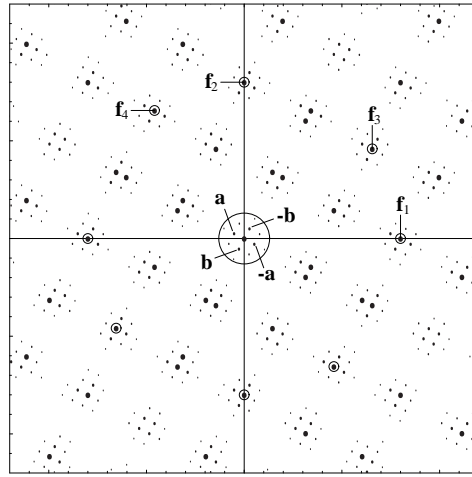

Figure 3.3 from the book: *The Theory of the Moiré Phenomenon* by I. Amidror, published by Kluwer Academic Publishers, 1999.



(a)



$$\mathbf{a} = \mathbf{f}_1 + 2\mathbf{f}_2 - 2\mathbf{f}_3 - \mathbf{f}_4$$

$$\mathbf{b} = -2\mathbf{f}_1 + \mathbf{f}_2 - \mathbf{f}_3 - 2\mathbf{f}_4$$

(b)

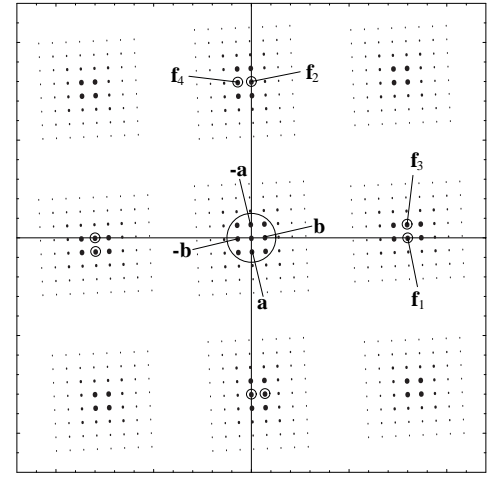

$$\mathbf{a} = \mathbf{f}_1 - \mathbf{f}_3$$

$$\mathbf{b} = \mathbf{f}_2 - \mathbf{f}_4$$

(c)

Figure 4.3 (bottom) from the book: *The Theory of the Moiré Phenomenon*
by I. Amidror, published by Kluwer Academic Publishers, 1999.

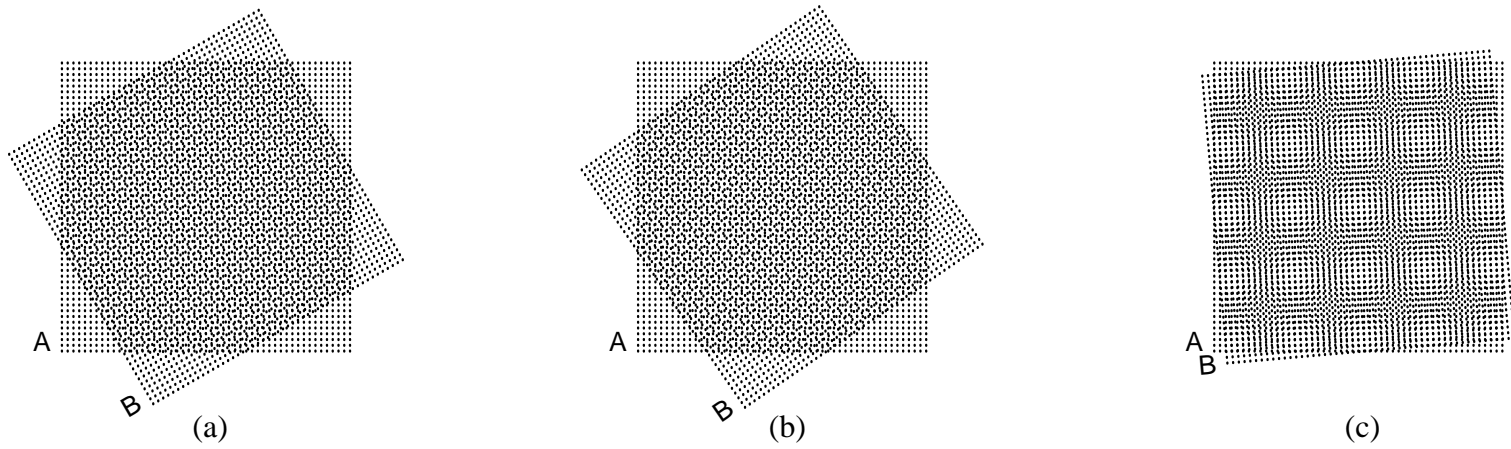

Figure 4.3 (top) from the book: *The Theory of the Moiré Phenomenon* by I. Amidror, published by Kluwer Academic Publishers, 1999.

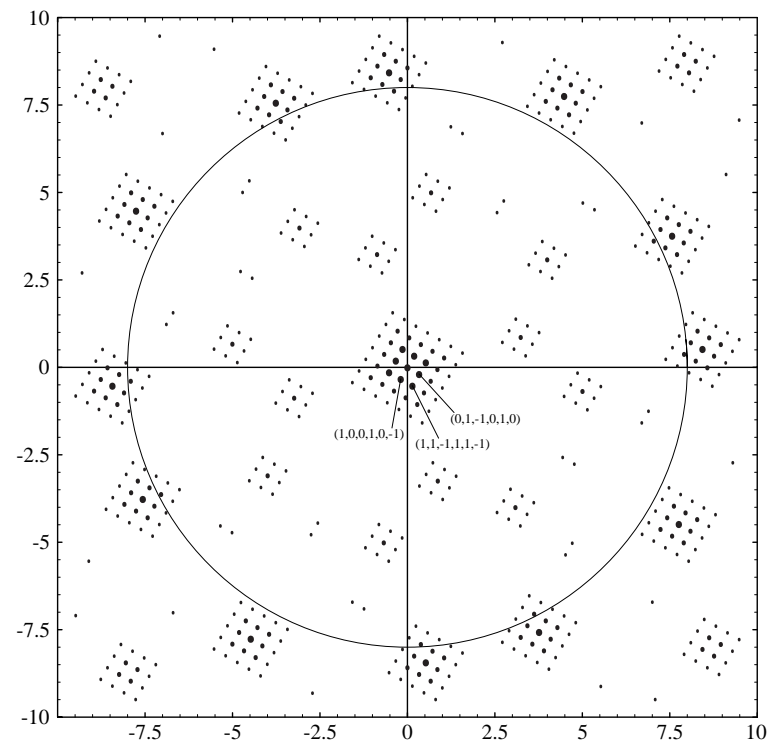
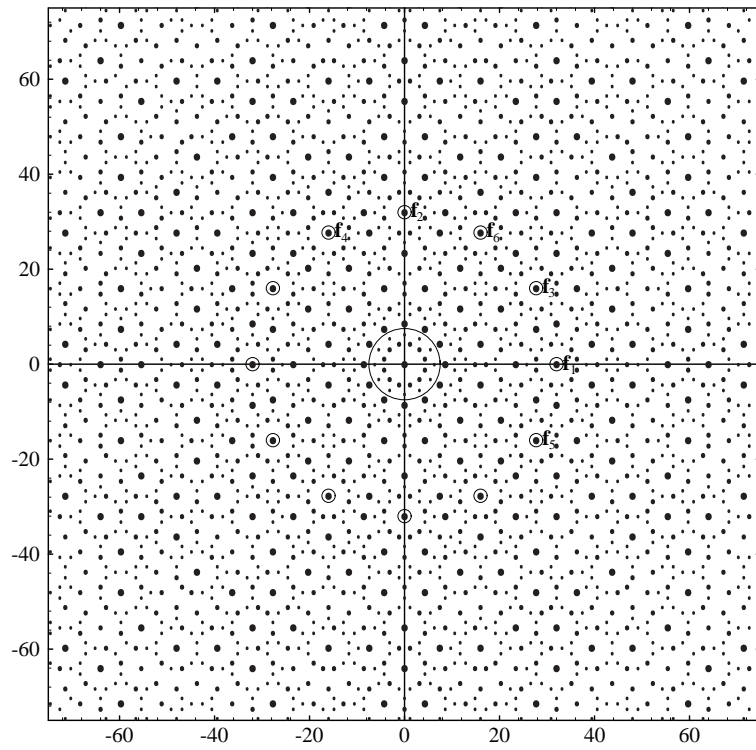
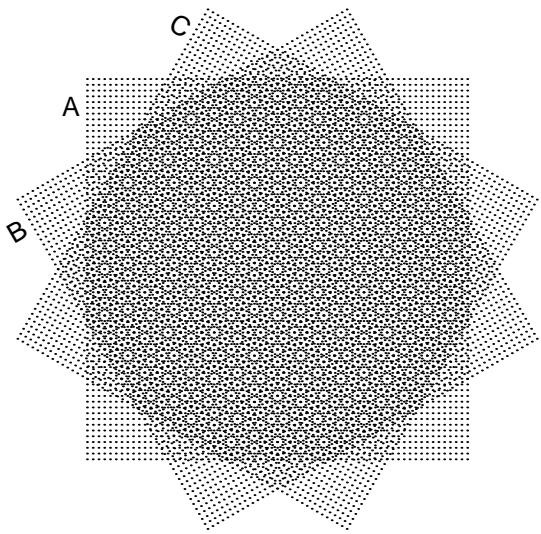
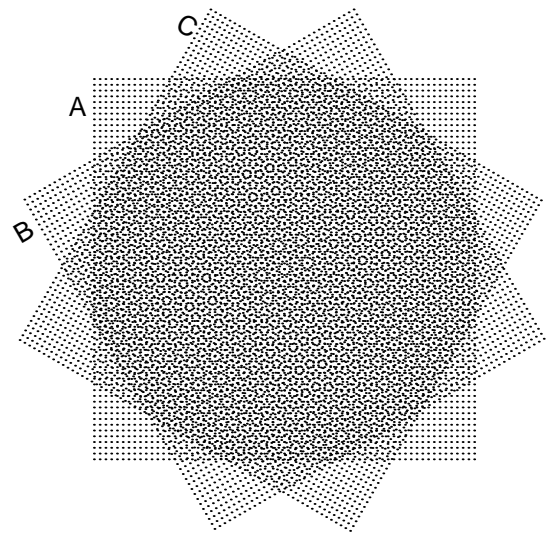

Figure 5.10 (bottom) from the book: *The Theory of the Moiré Phenomenon*
 by I. Amidror, published by Kluwer Academic Publishers, 1999.



(a)



(b)

Figure 5.10 (top) from the book: *The Theory of the Moiré Phenomenon* by I. Amidror, published by Kluwer Academic Publishers, 1999.

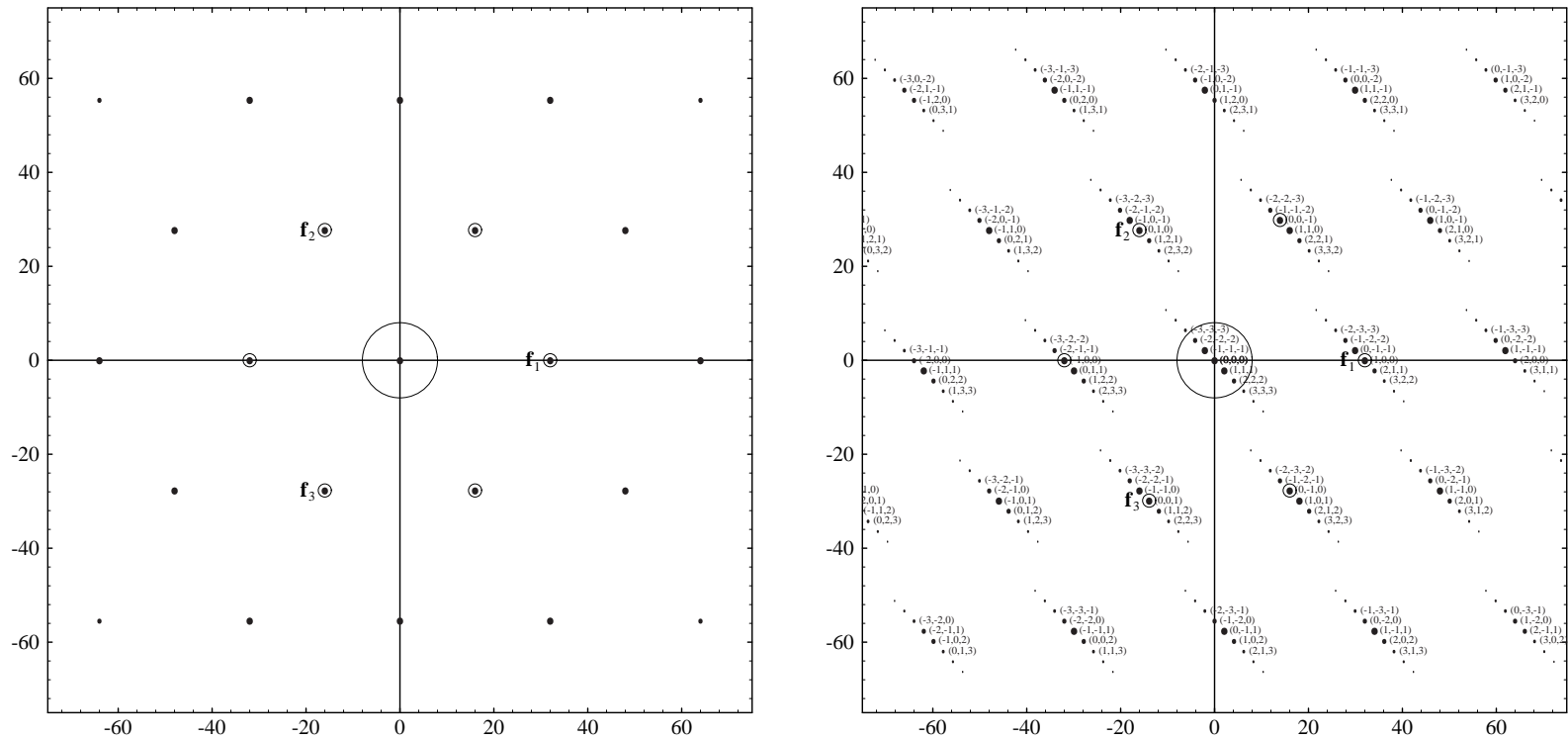

Figure 5.2 (bottom) from the book: *The Theory of the Moiré Phenomenon*
 by I. Amidror, published by Kluwer Academic Publishers, 1999.

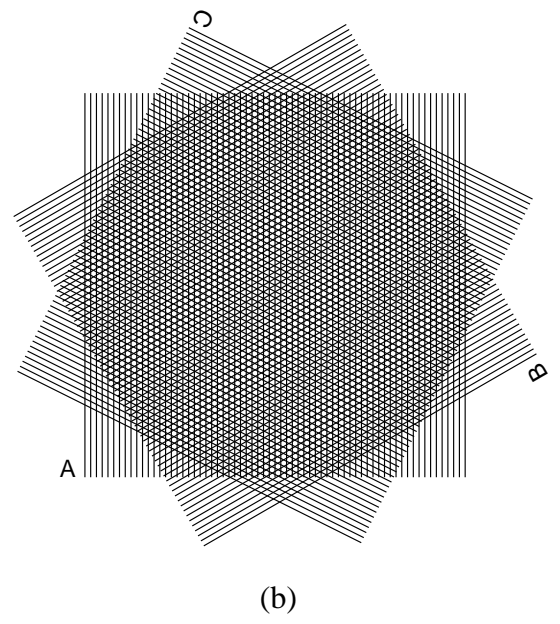
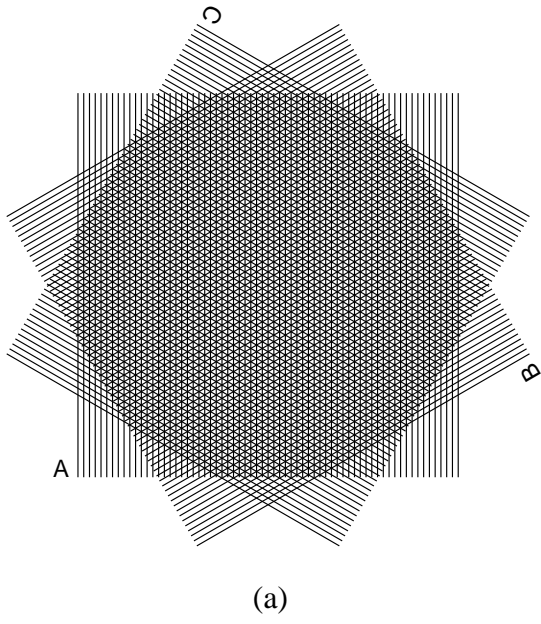

Figure 5.2 (top) from the book: *The Theory of the Moiré Phenomenon* by I. Amidror, published by Kluwer Academic Publishers, 1999.

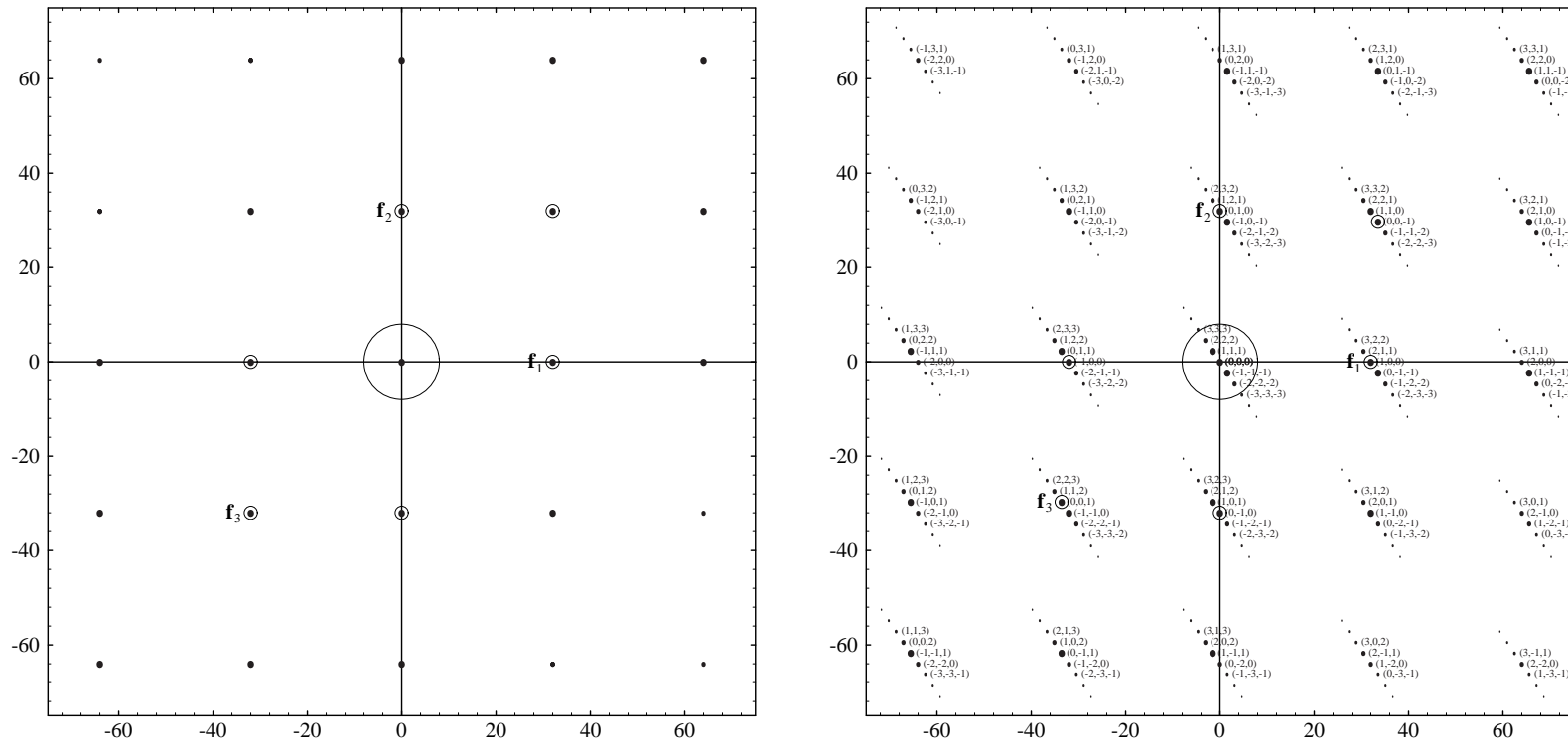

Figure 5.3 (bottom) from the book: *The Theory of the Moiré Phenomenon*
 by I. Amidror, published by Kluwer Academic Publishers, 1999.

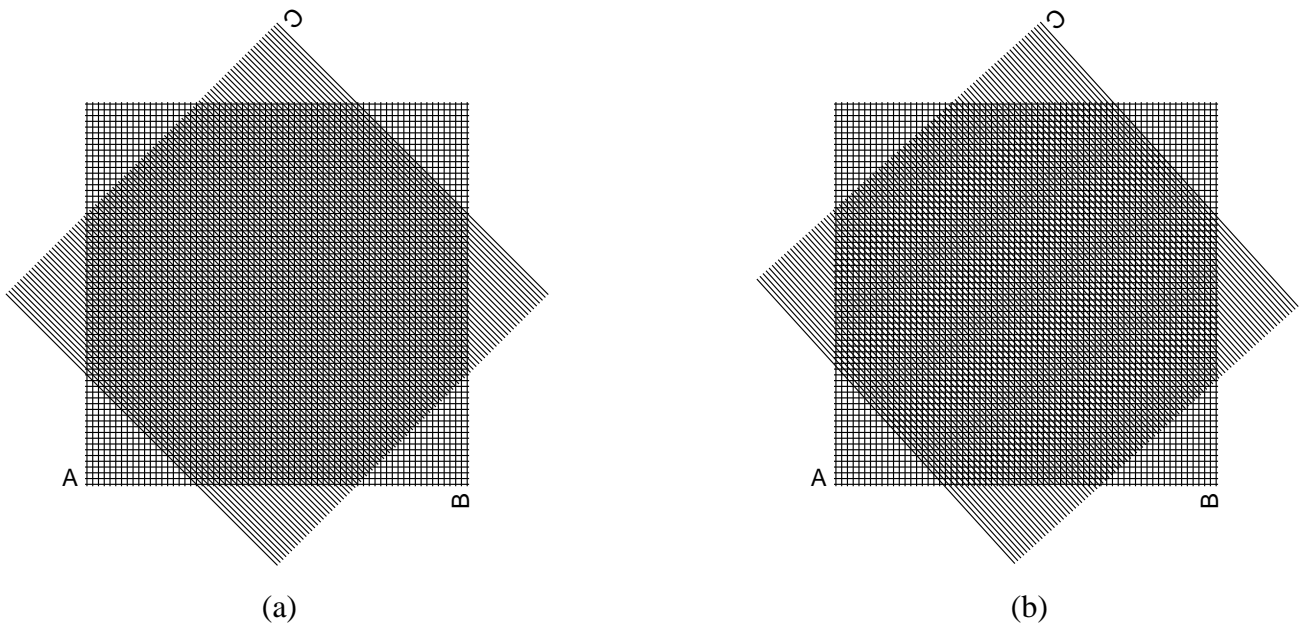

Figure 5.3 (top) from the book: *The Theory of the Moiré Phenomenon* by I. Amidror, published by Kluwer Academic Publishers, 1999.

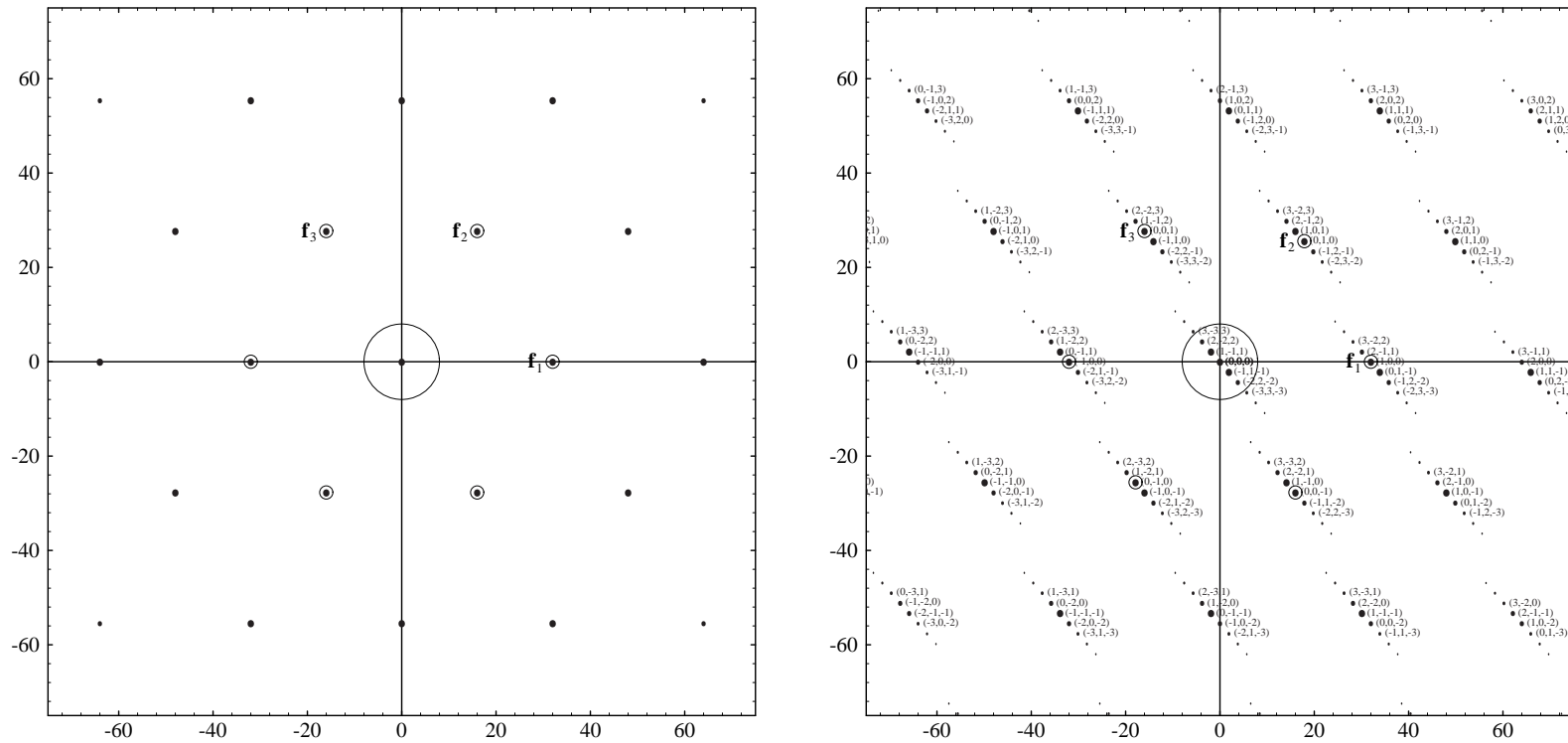

Figure 5.4 (bottom) from the book: *The Theory of the Moiré Phenomenon*
by I. Amidror, published by Kluwer Academic Publishers, 1999.

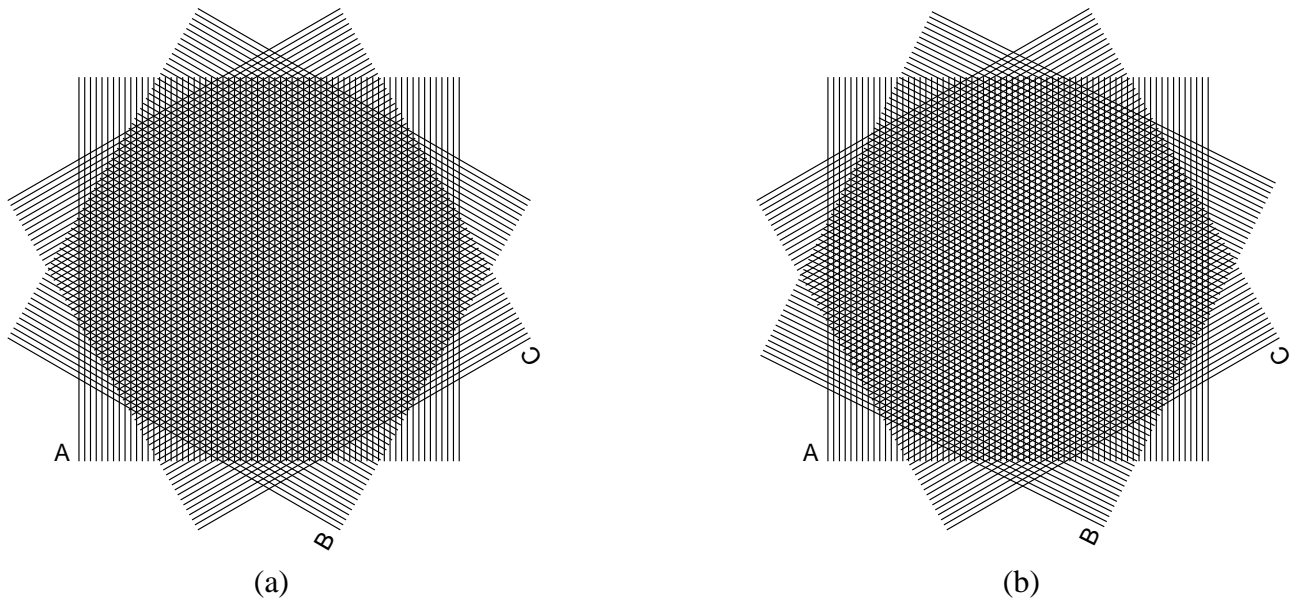

Figure 5.4 (top) from the book: *The Theory of the Moiré Phenomenon* by I. Amidror, published by Kluwer Academic Publishers, 1999.

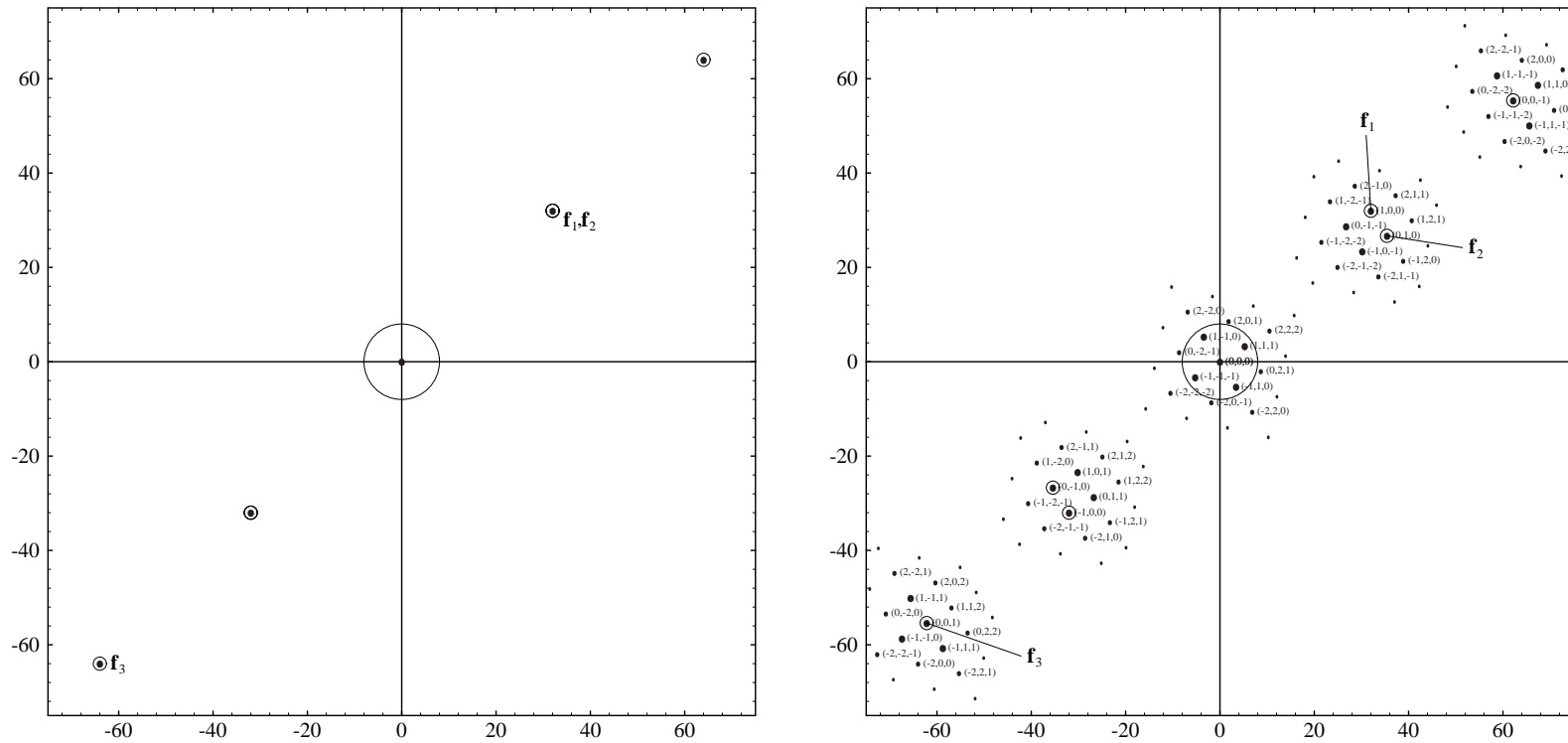

Figure 5.5 (bottom) from the book: *The Theory of the Moiré Phenomenon*
 by I. Amidror, published by Kluwer Academic Publishers, 1999.

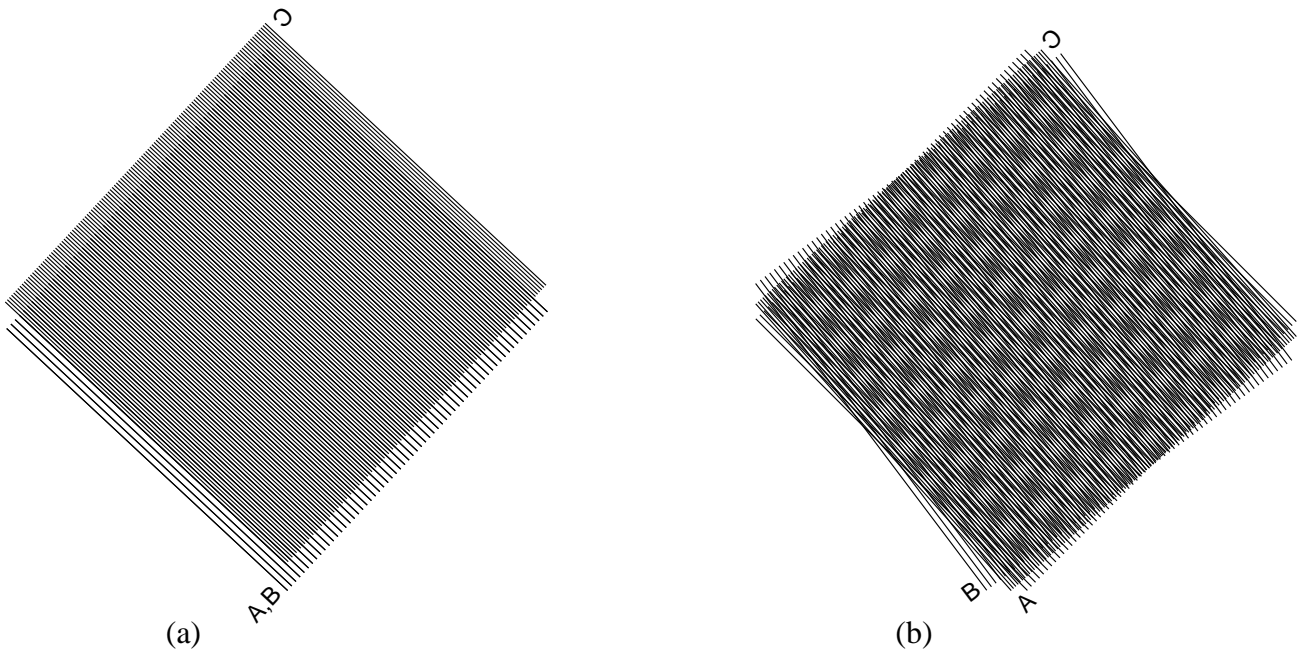

Figure 5.5 (top) from the book: *The Theory of the Moiré Phenomenon* by I. Amidror, published by Kluwer Academic Publishers, 1999.

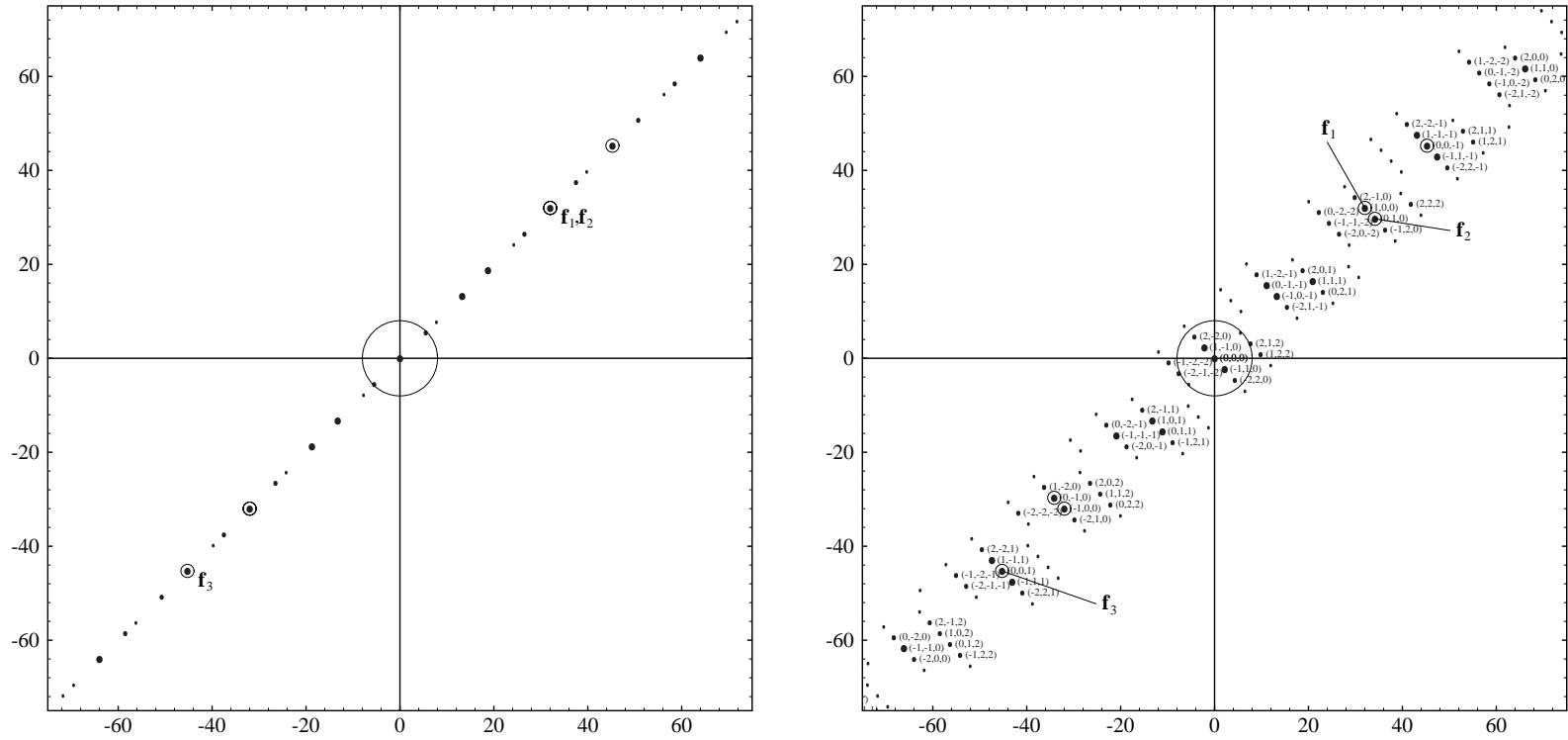

Figure 5.6 (bottom) from the book: *The Theory of the Moiré Phenomenon*
by I. Amidror, published by Kluwer Academic Publishers, 1999.

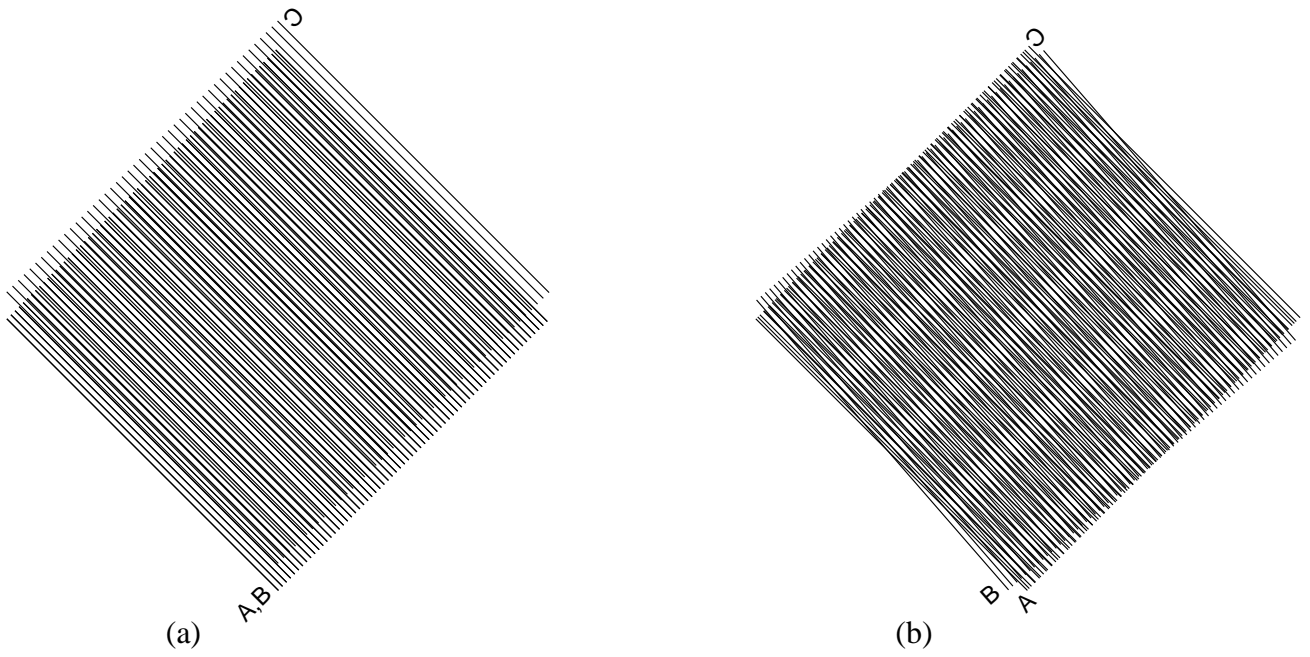

Figure 5.6 (top) from the book: *The Theory of the Moiré Phenomenon* by I. Amidror, published by Kluwer Academic Publishers, 1999.

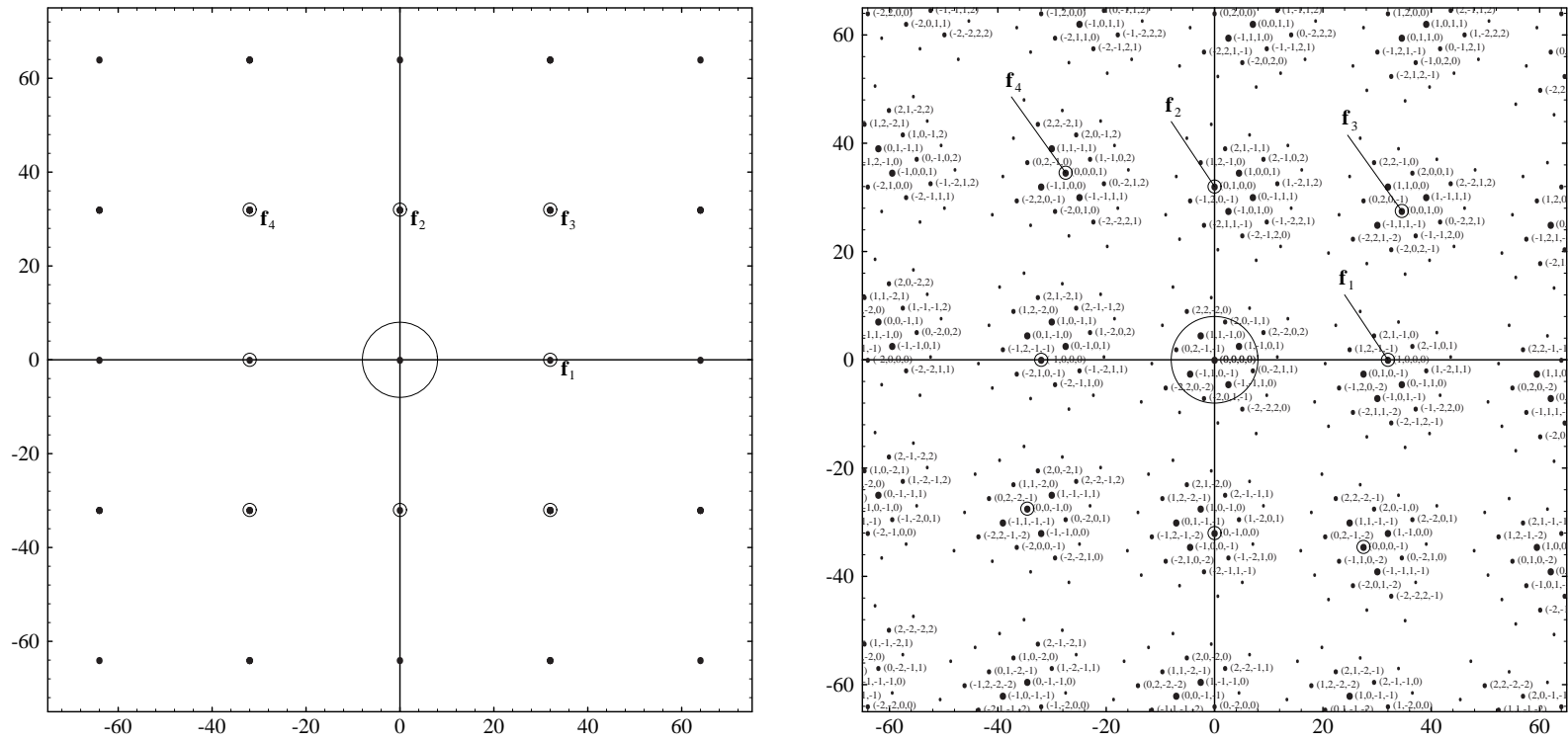

Figure 5.7 (bottom) from the book: *The Theory of the Moiré Phenomenon* by I. Amidror, published by Kluwer Academic Publishers, 1999.

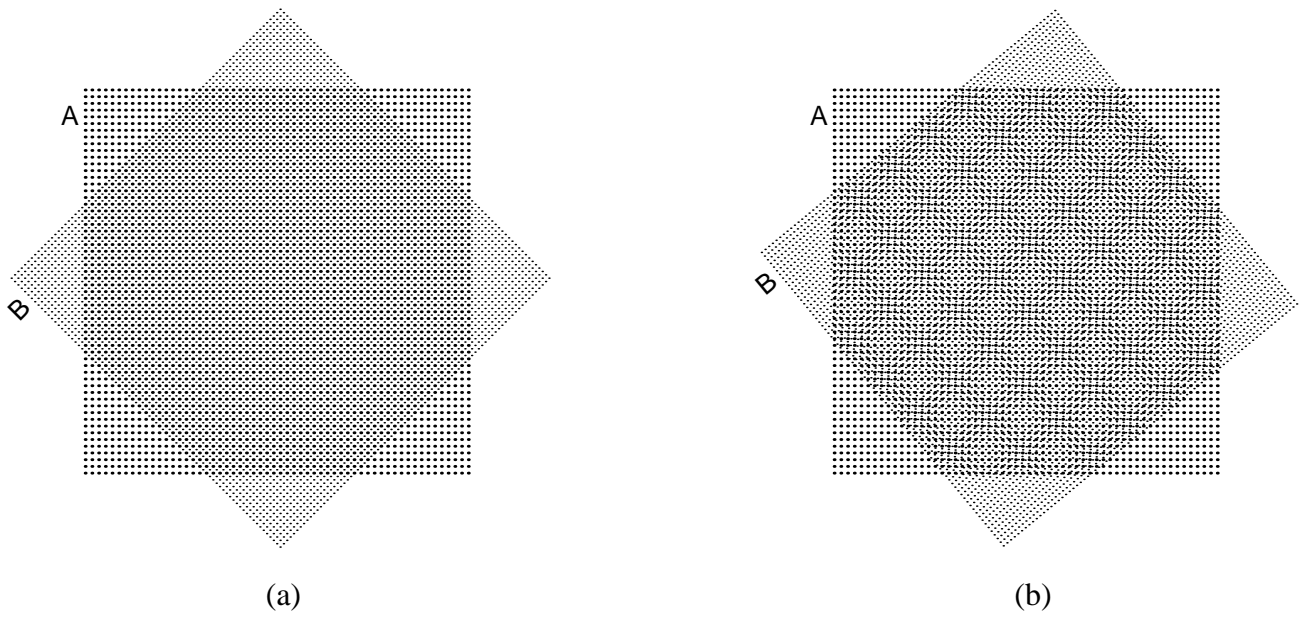

Figure 5.7 (top) from the book: *The Theory of the Moiré Phenomenon* by I. Amidror, published by Kluwer Academic Publishers, 1999.

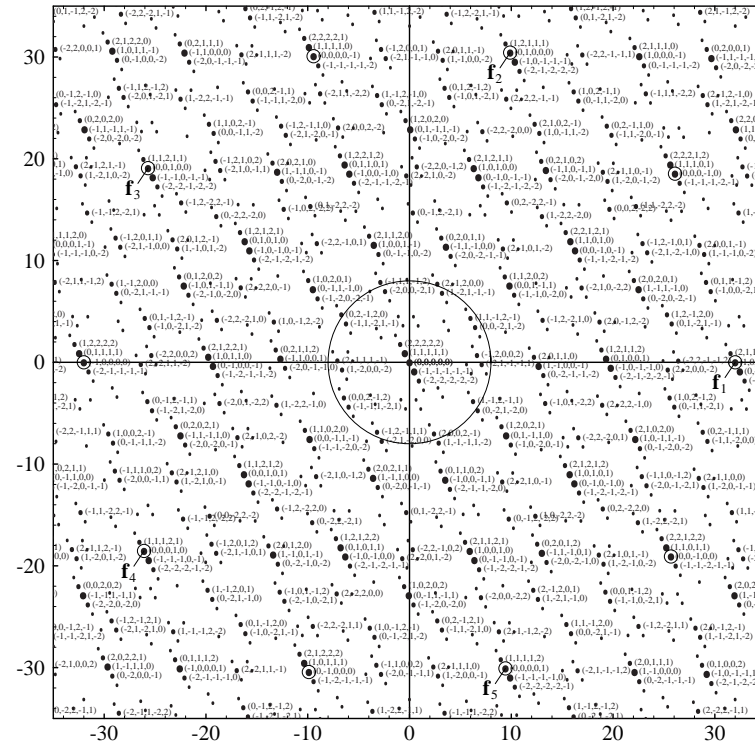
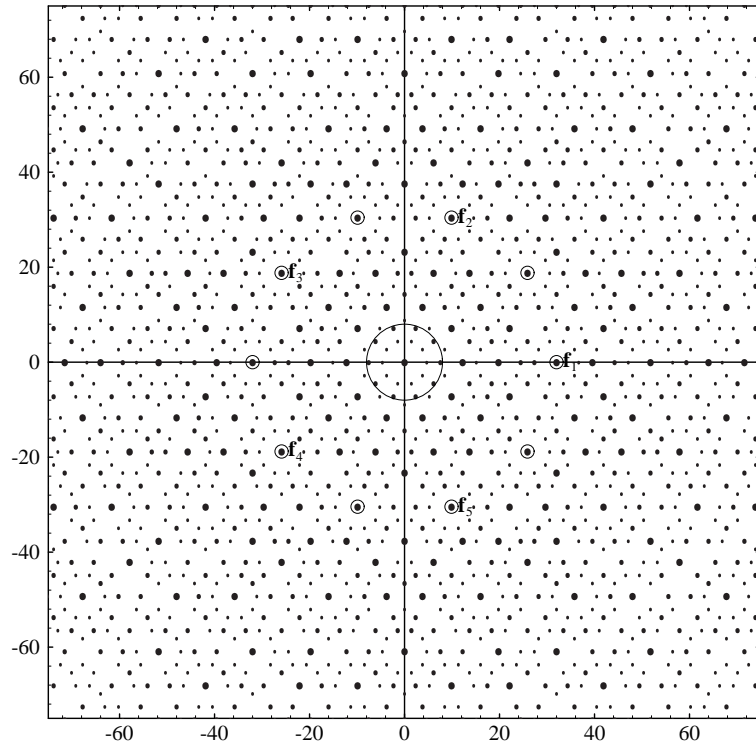

Figure 5.8 (bottom) from the book: *The Theory of the Moiré Phenomenon* by I. Amidror, published by Kluwer Academic Publishers, 1999.

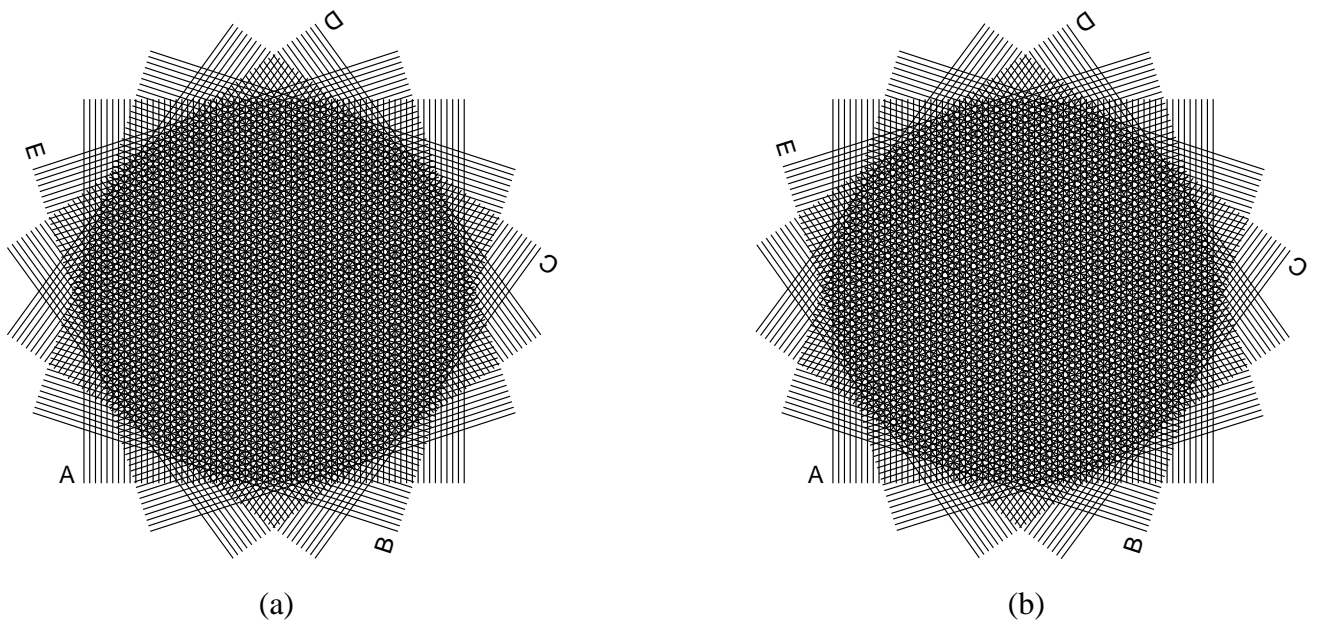

Figure 5.8 (top) from the book: *The Theory of the Moiré Phenomenon* by I. Amidror, published by Kluwer Academic Publishers, 1999.

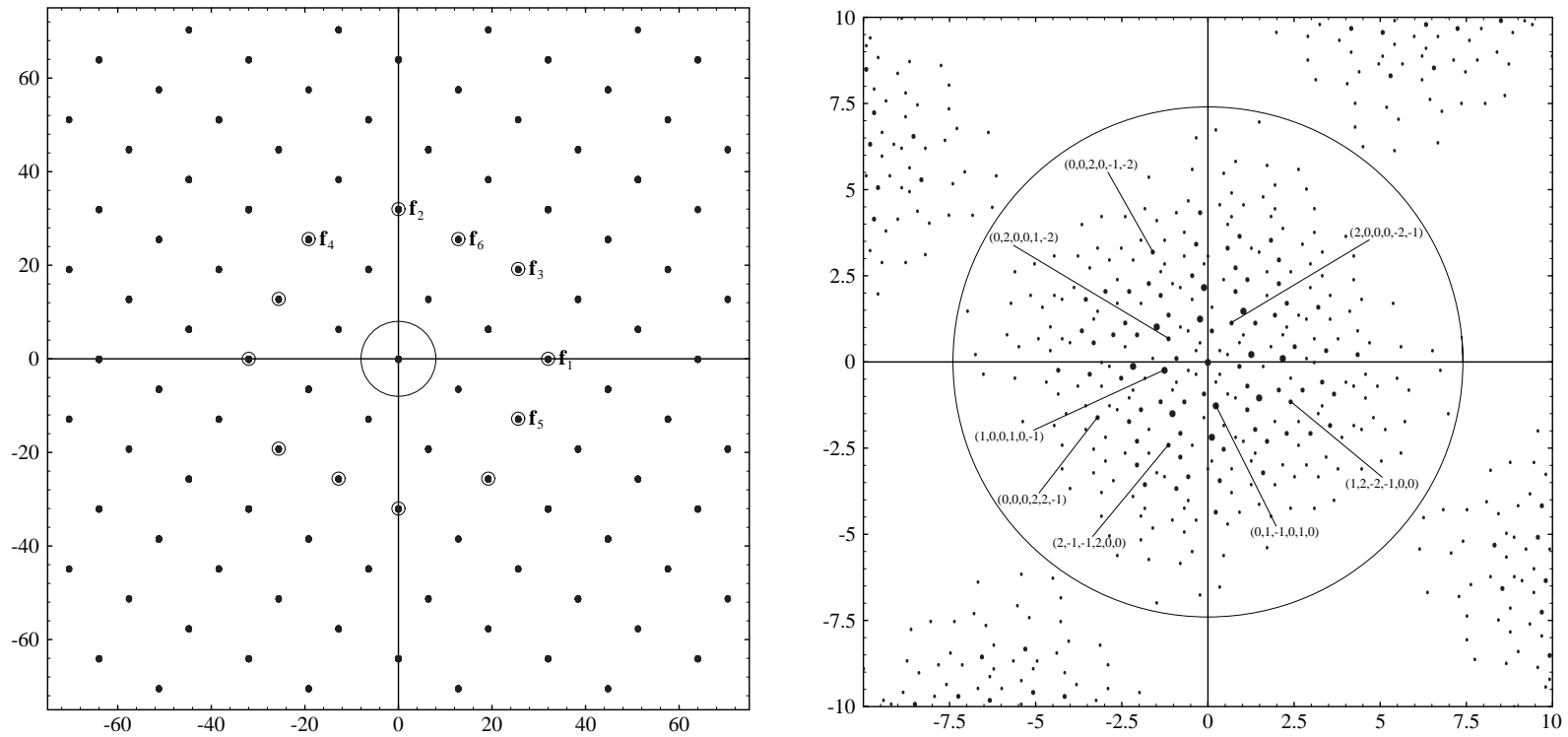

Figure 5.9 (bottom) from the book: *The Theory of the Moiré Phenomenon*
 by I. Amidror, published by Kluwer Academic Publishers, 1999.

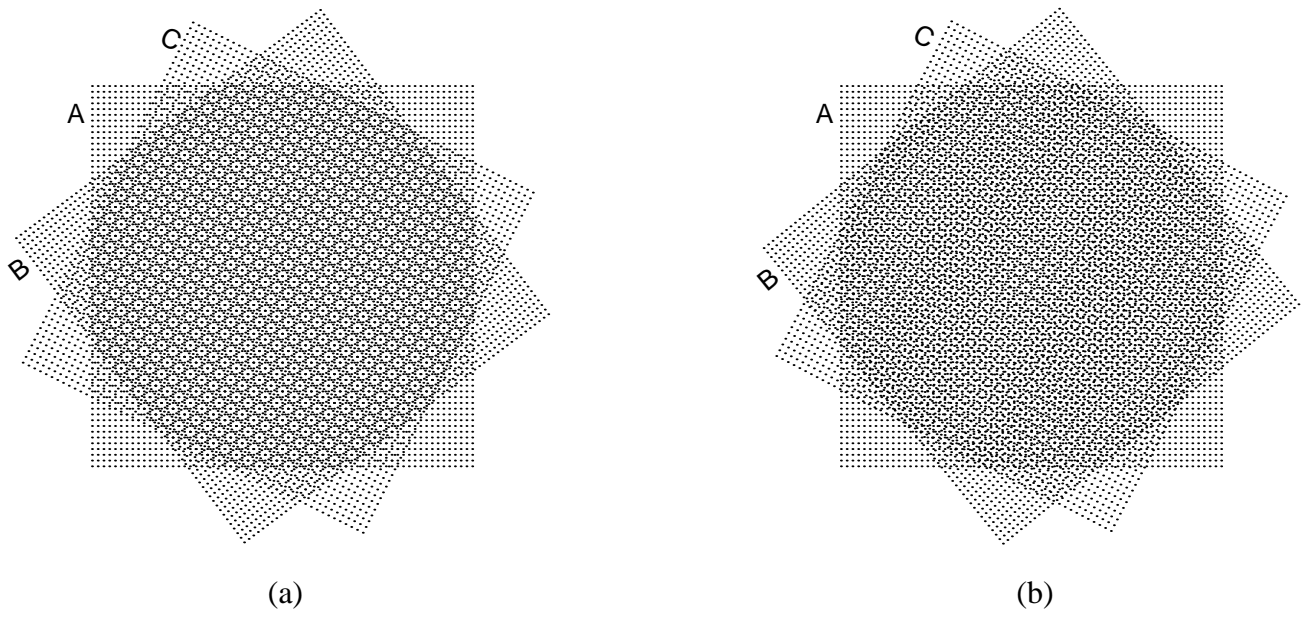
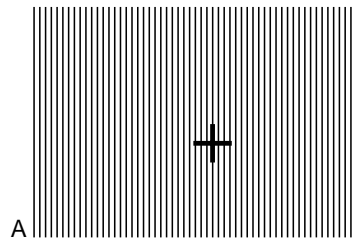

Figure 5.9 (top) from the book: *The Theory of the Moiré Phenomenon* by I. Amidror, published by Kluwer Academic Publishers, 1999.



(a)

Figure 7.3(a) from the book: *The Theory of the Moiré Phenomenon*
by I. Amidror, published by Kluwer Academic Publishers, 1999.

(First layer only.)

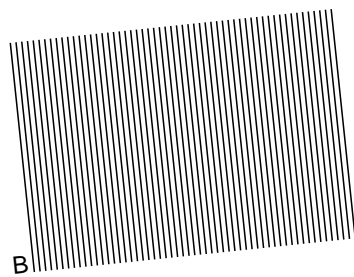

(a)

Figure 7.3(a) from the book: *The Theory of the Moiré Phenomenon*
by I. Amidror, published by Kluwer Academic Publishers, 1999.

(Second layer only.)

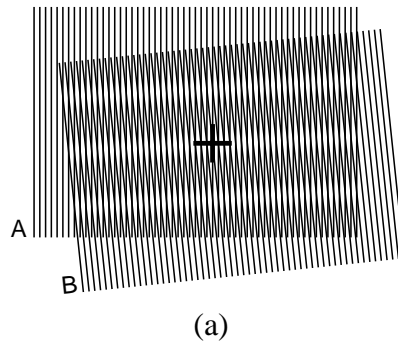
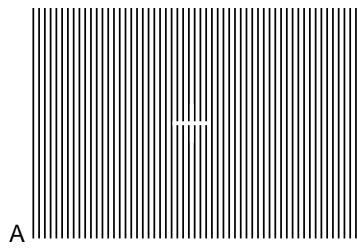

Figure 7.3(a) from the book: *The Theory of the Moiré Phenomenon* by I. Amidror, published by Kluwer Academic Publishers, 1999.



(a)

Figure 7.5(a) from the book: *The Theory of the Moiré Phenomenon*
by I. Amidror, published by Kluwer Academic Publishers, 1999.

(First layer only.)

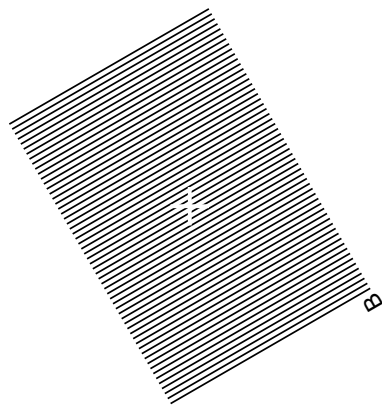

(a)

Figure 7.5(a) from the book: *The Theory of the Moiré Phenomenon*
by I. Amidror, published by Kluwer Academic Publishers, 1999.

(Second layer only.)

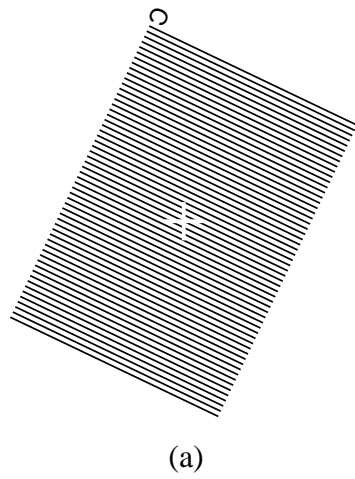

Figure 7.5(a) from the book: *The Theory of the Moiré Phenomenon*
by I. Amidror, published by Kluwer Academic Publishers, 1999.

(Third layer only.)

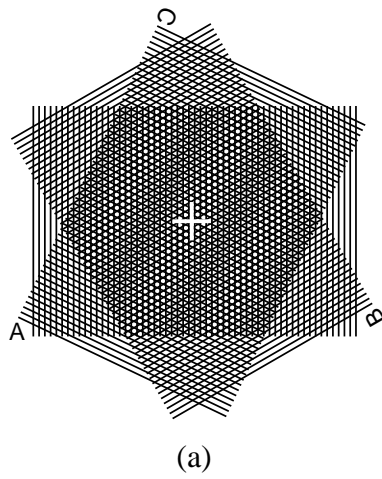

Figure 7.5(a) from the book: *The Theory of the Moiré Phenomenon* by I. Amidror, published by Kluwer Academic Publishers, 1999.

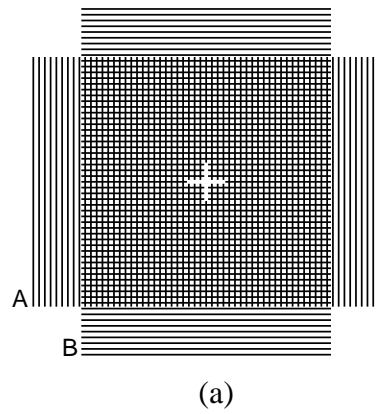

Figure 7.6(a) from the book: *The Theory of the Moiré Phenomenon*
by I. Amidror, published by Kluwer Academic Publishers, 1999.

(First layer only.)

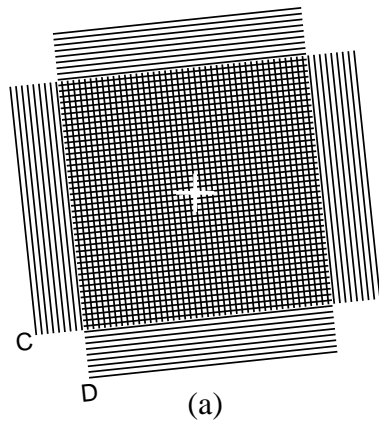

Figure 7.6(a) from the book: *The Theory of the Moiré Phenomenon*
by I. Amidror, published by Kluwer Academic Publishers, 1999.

(Second layer only.)

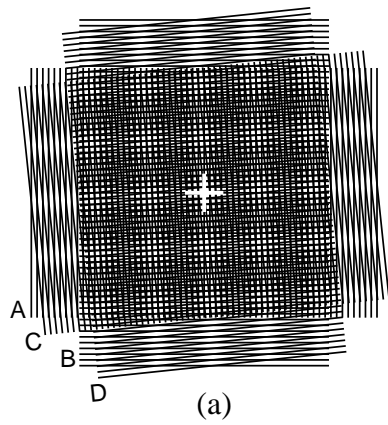
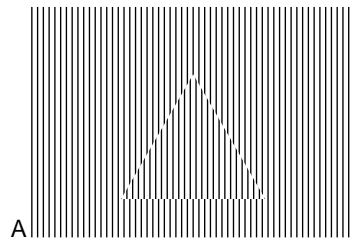

Figure 7.6(a) from the book: *The Theory of the Moiré Phenomenon* by I. Amidror, published by Kluwer Academic Publishers, 1999.



(d)

Figure 7.8(d) from the book: *The Theory of the Moiré Phenomenon*
by I. Amidror, published by Kluwer Academic Publishers, 1999.

(First layer only.)

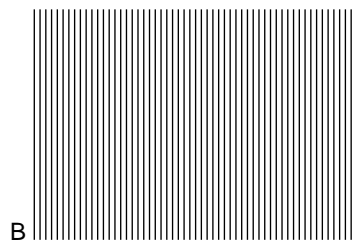

(d)

Figure 7.8(d) from the book: *The Theory of the Moiré Phenomenon*
by I. Amidror, published by Kluwer Academic Publishers, 1999.

(Second layer only.)

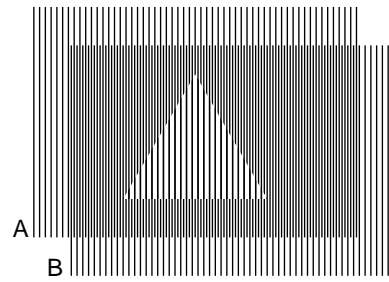

(d)

Figure 7.8(d) from the book: *The Theory of the Moiré Phenomenon*
by I. Amidror, published by Kluwer Academic Publishers, 1999.

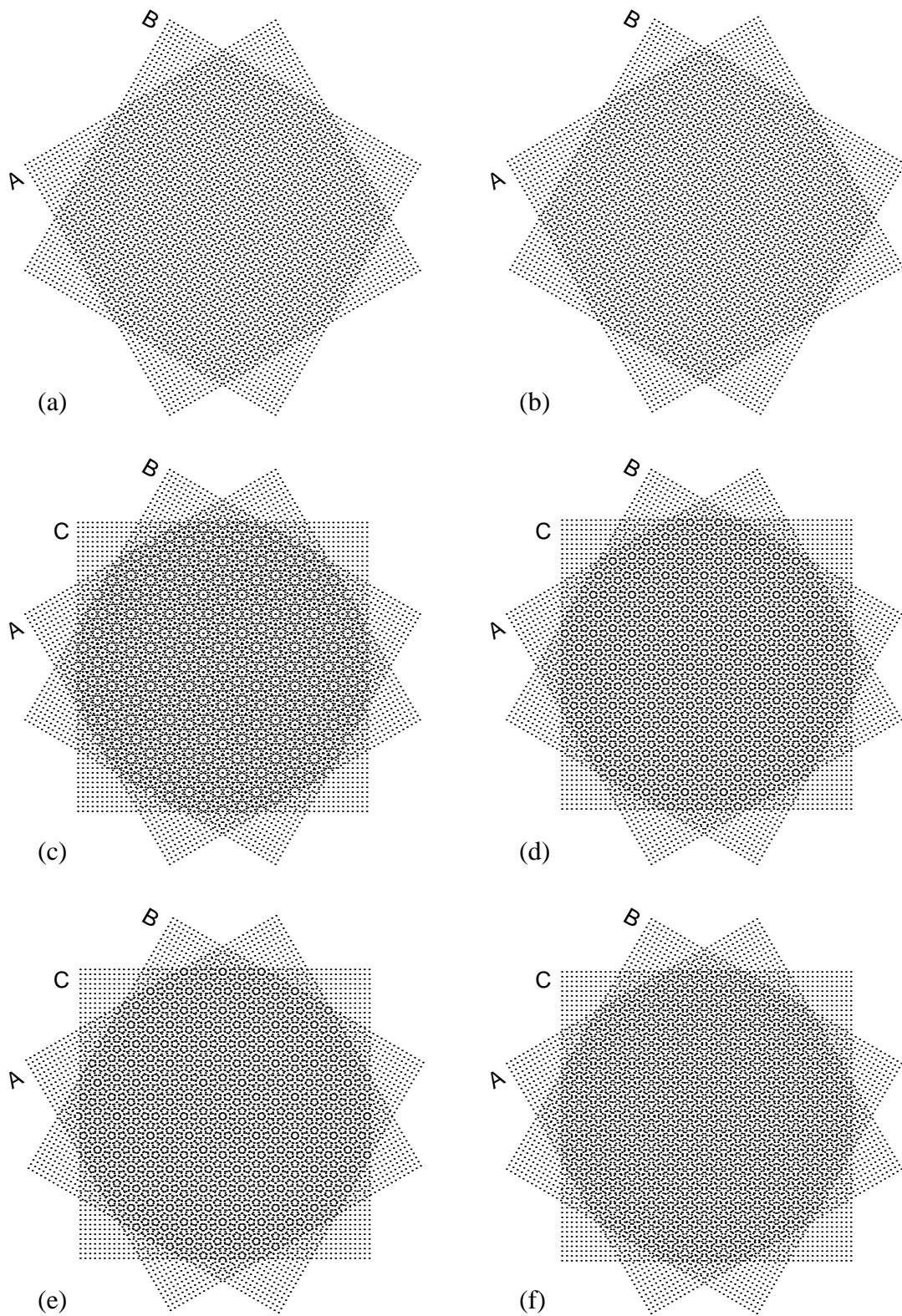

Figure 8.14 from the book: *The Theory of the Moiré Phenomenon* by I. Amidror, published by Kluwer Academic Publishers, 1999.

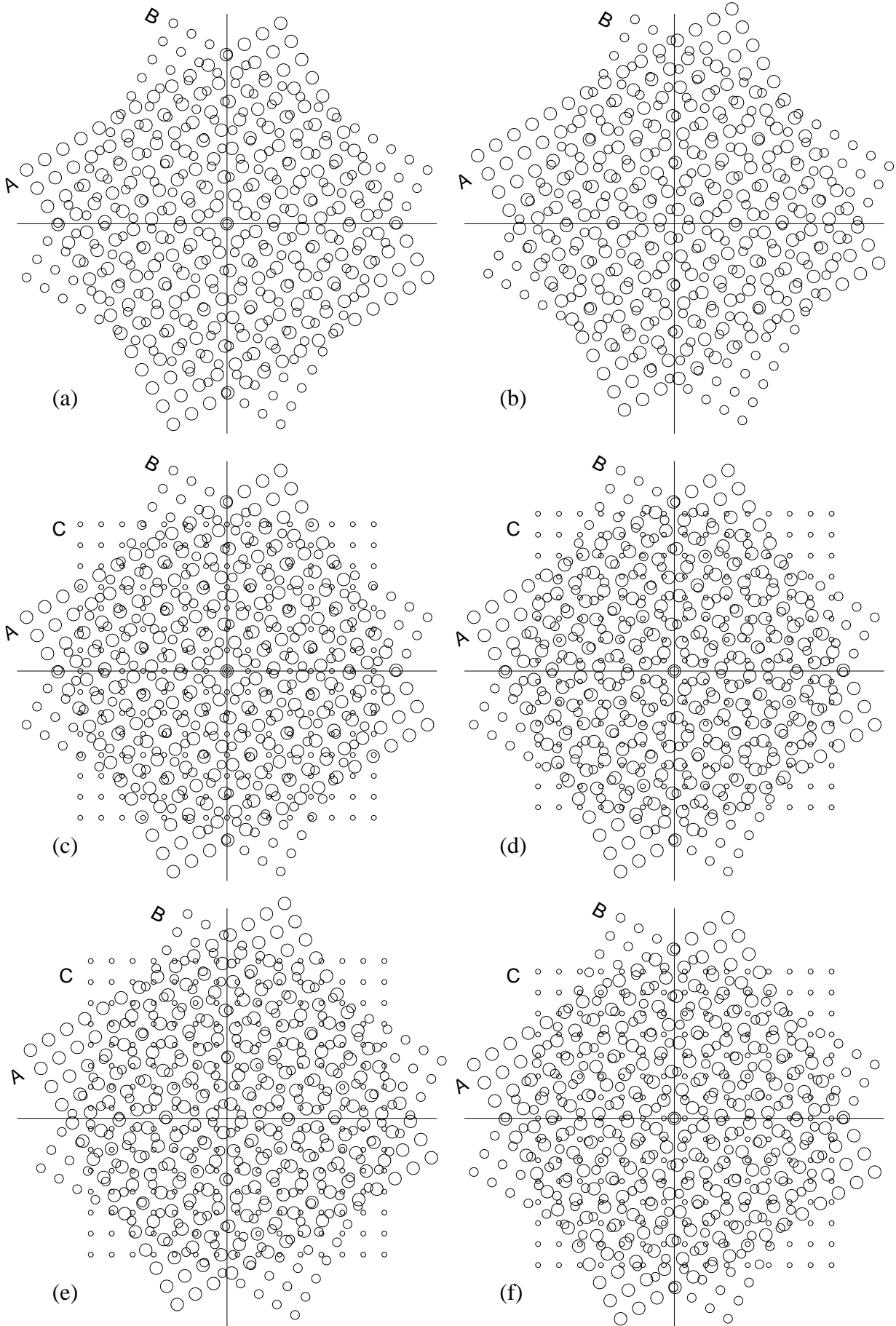
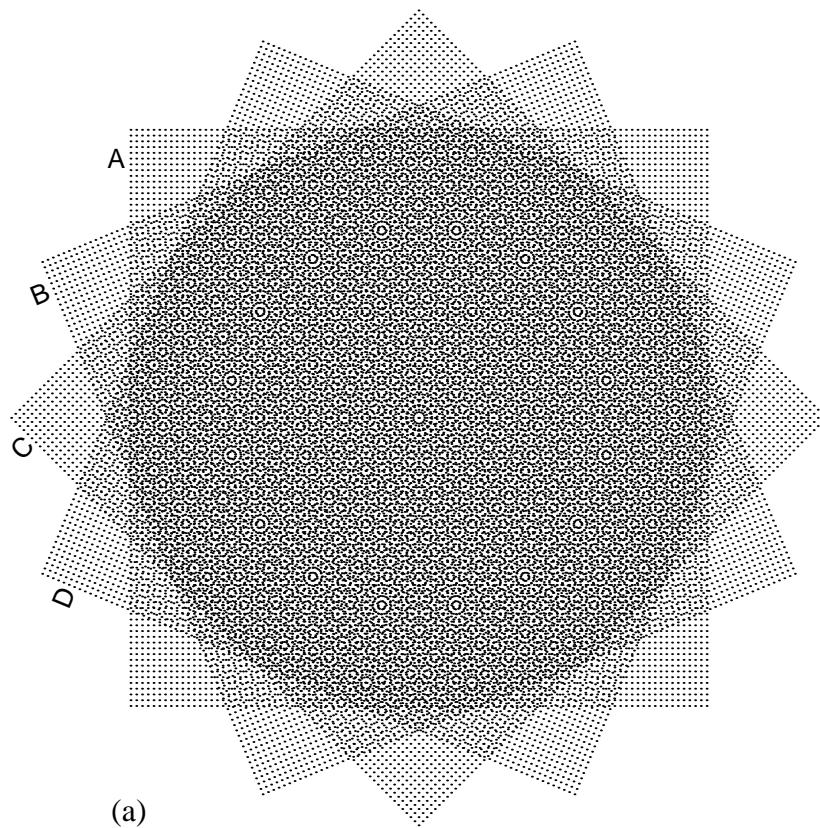
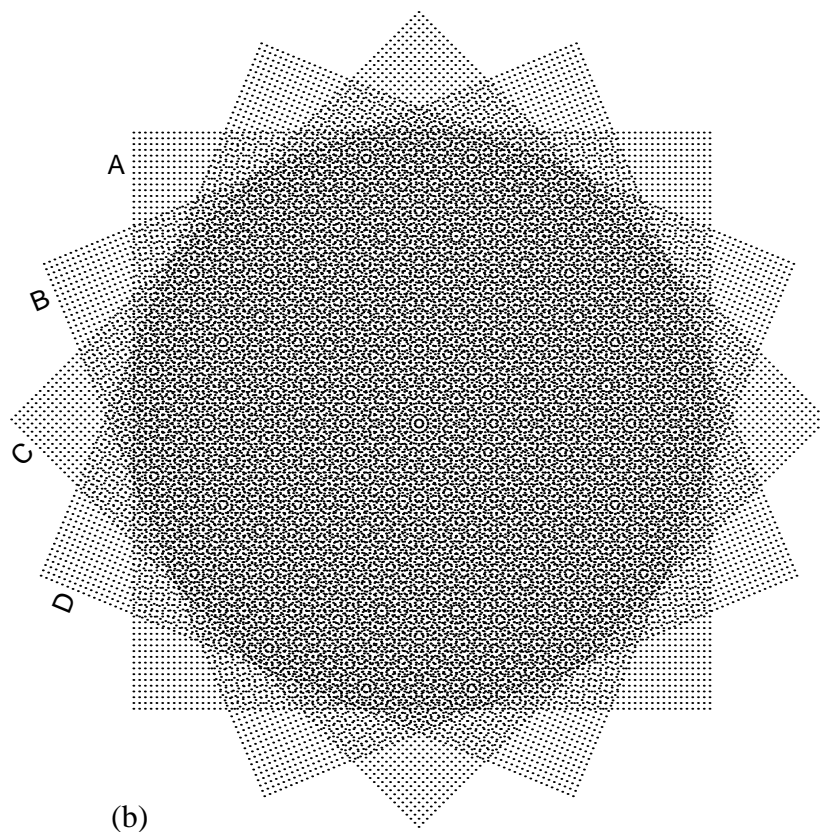

Figure 8.15 from the book: *The Theory of the Moiré Phenomenon* by I. Amidror, published by Kluwer Academic Publishers, 1999.



(a)



(b)

Figure 8.16 from the book: *The Theory of the Moiré Phenomenon* by I. Amidror, published by Kluwer Academic Publishers, 1999.

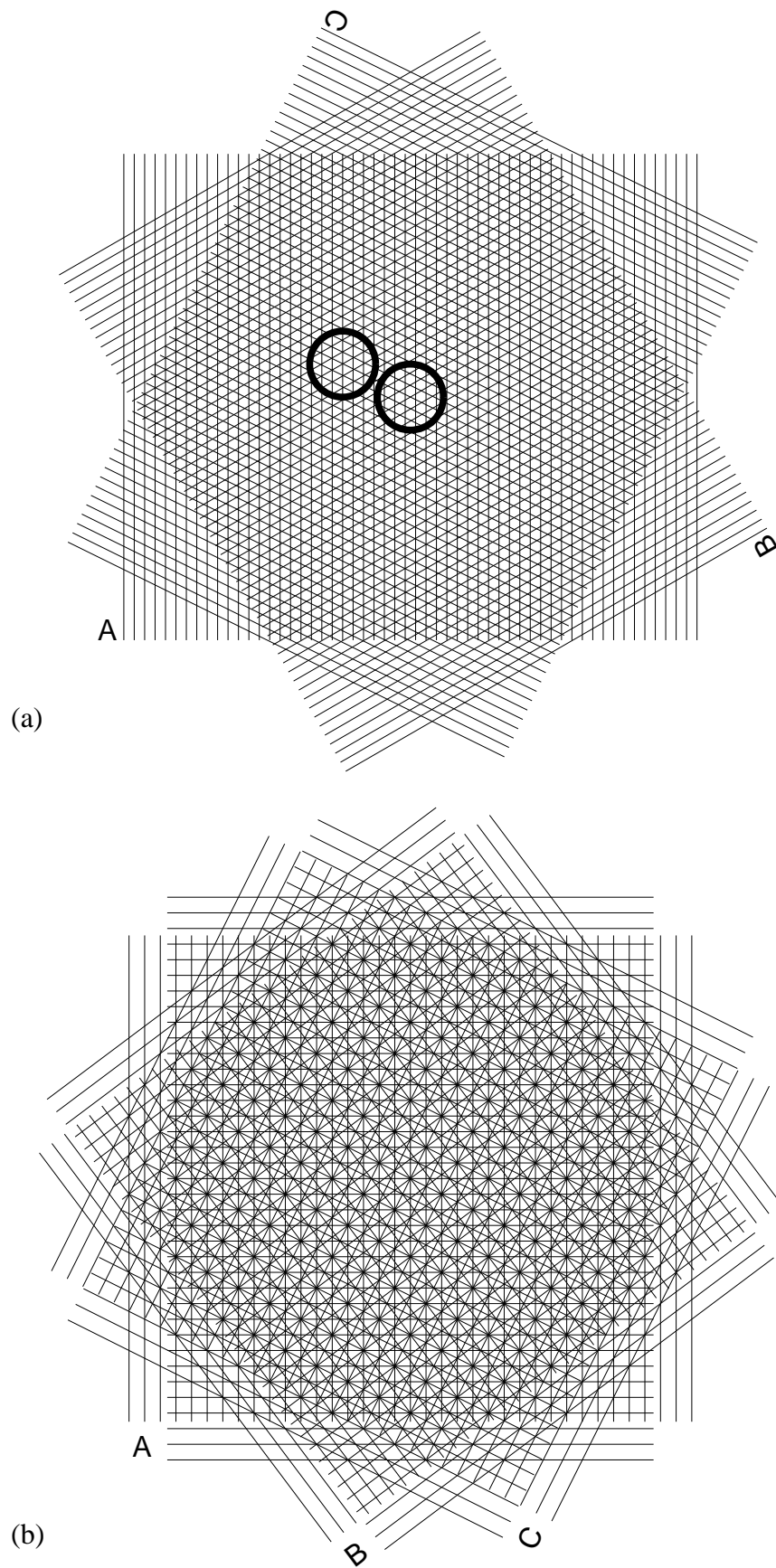

Figure 8.1 from the book: *The Theory of the Moiré Phenomenon* by I. Amidror, published by Kluwer Academic Publishers, 1999.

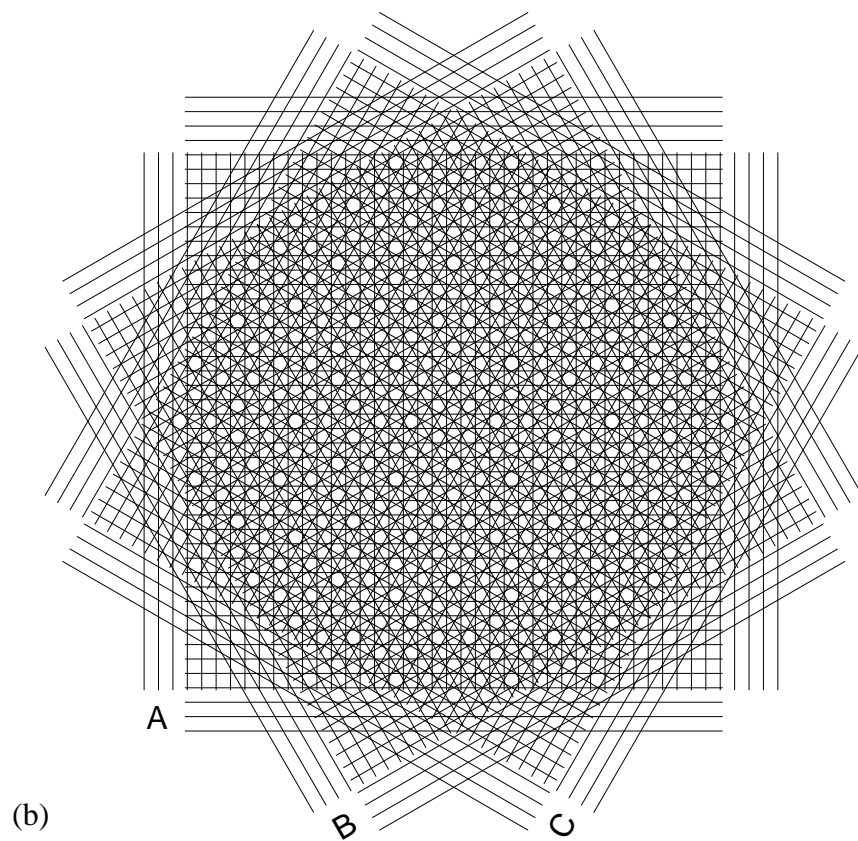
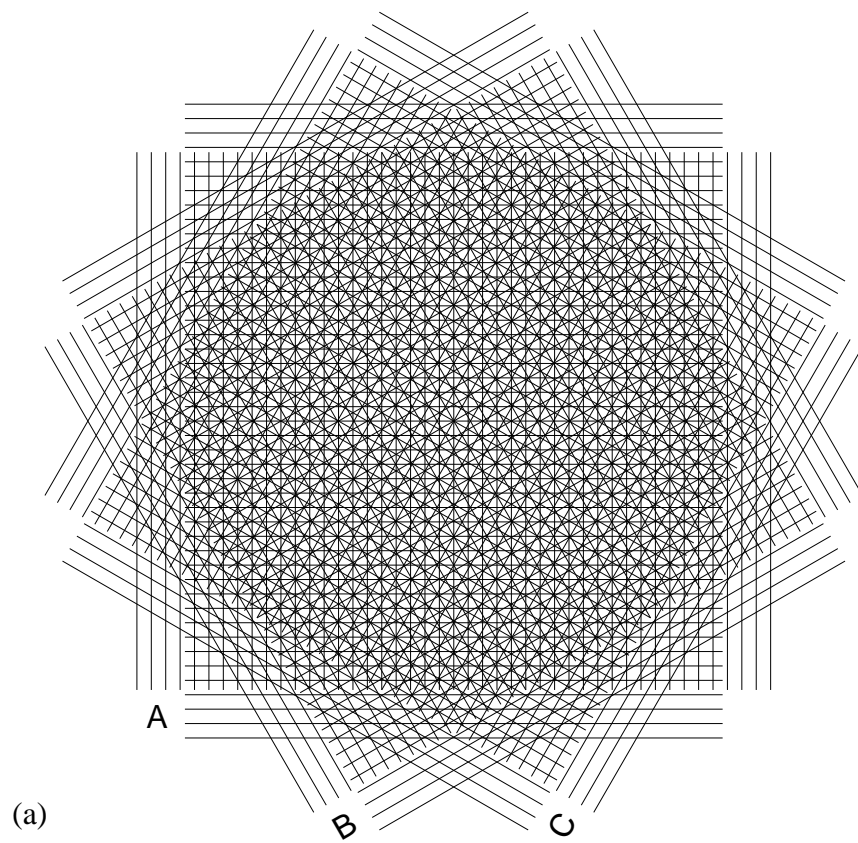

Figure 8.2 from the book: *The Theory of the Moiré Phenomenon* by I. Amidror, published by Kluwer Academic Publishers, 1999.

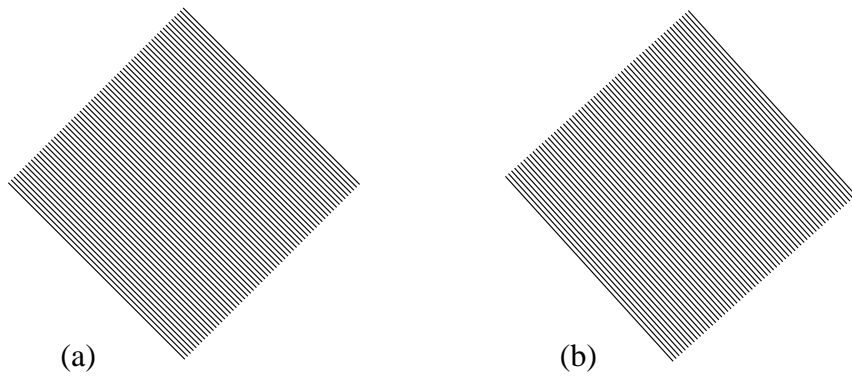

Figure C.6 from the book: *The Theory of the Moiré Phenomenon*
by I. Amidror, published by Kluwer Academic Publishers, 1999.

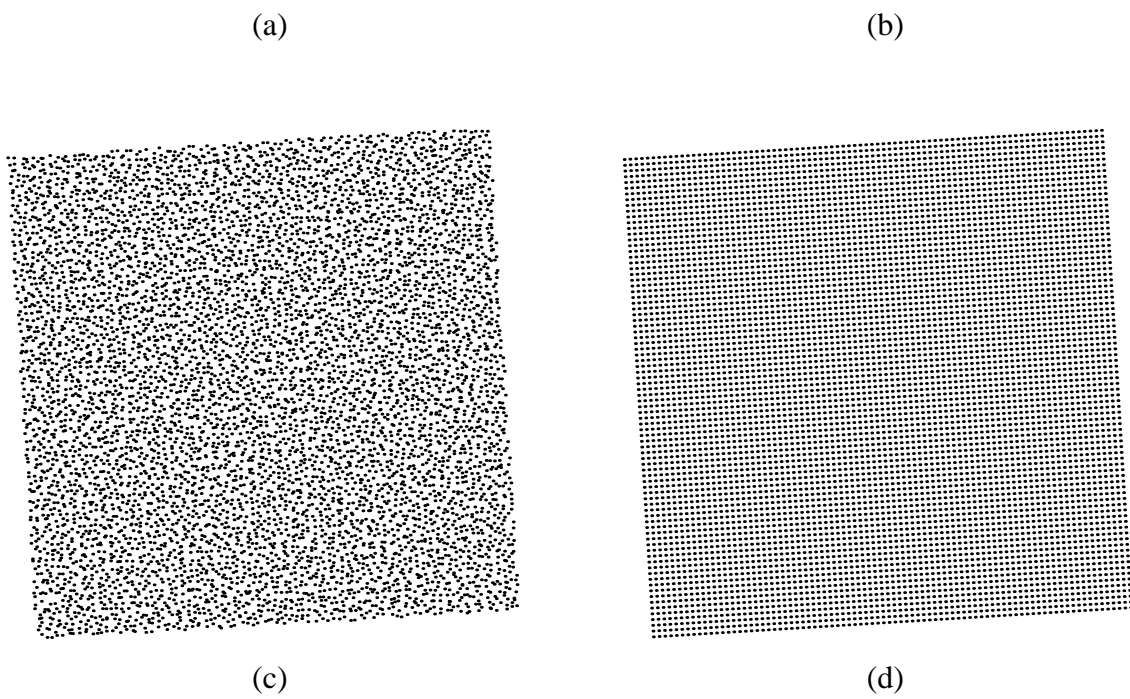
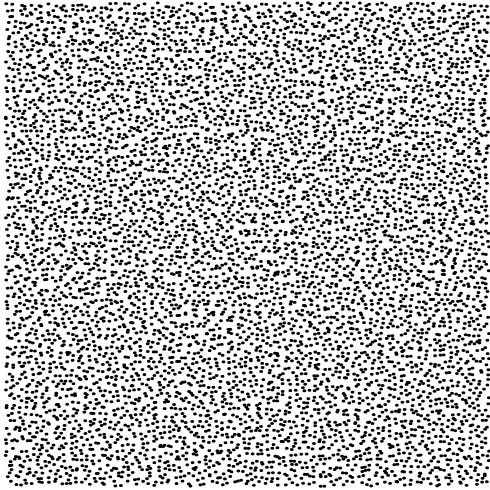
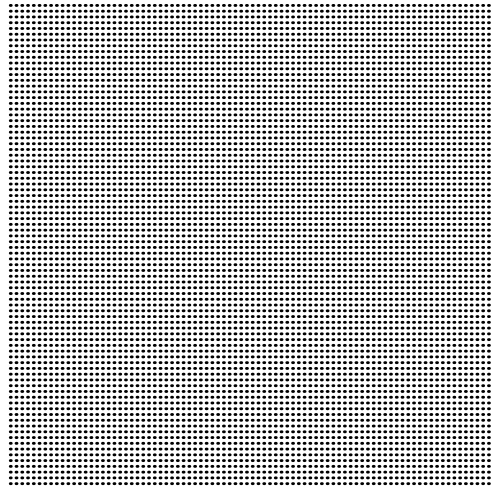

Figure 2.1(a)-(d) from the book: *The Theory of the Moiré Phenomenon*
Vol. II: Aperiodic Layers, by I. Amidror, published by Springer, 2007.

(First layer only.)



(a)



(b)

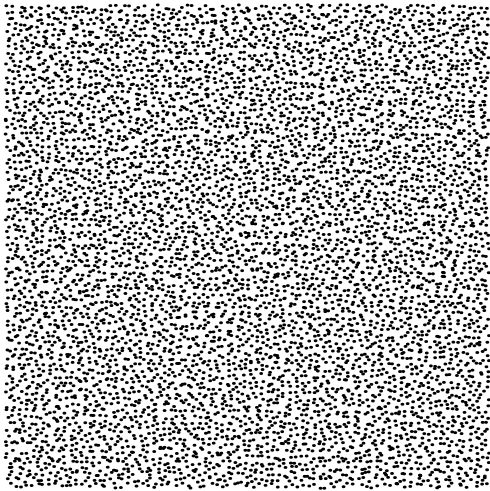

(c)

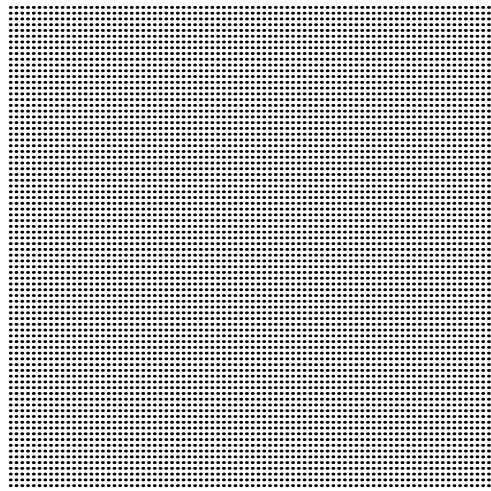

(d)

Figure 2.1(a)-(d) from the book: *The Theory of the Moiré Phenomenon Vol. II: Aperiodic Layers*, by I. Amidror, published by Springer, 2007.

(Second layer only.)

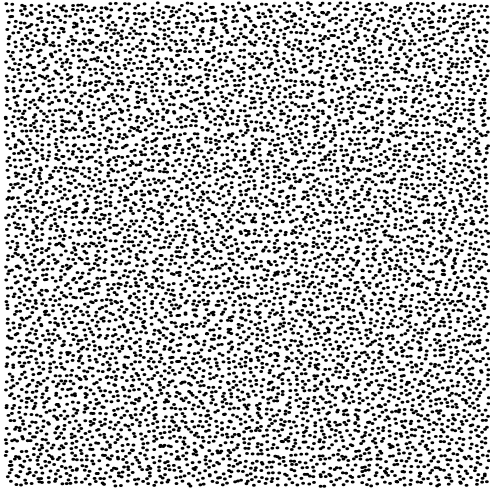

(a)

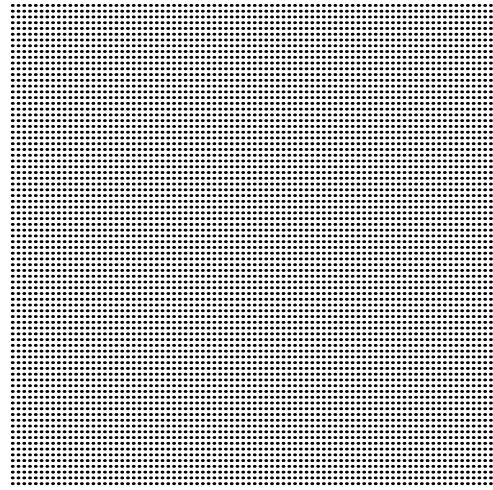

(b)

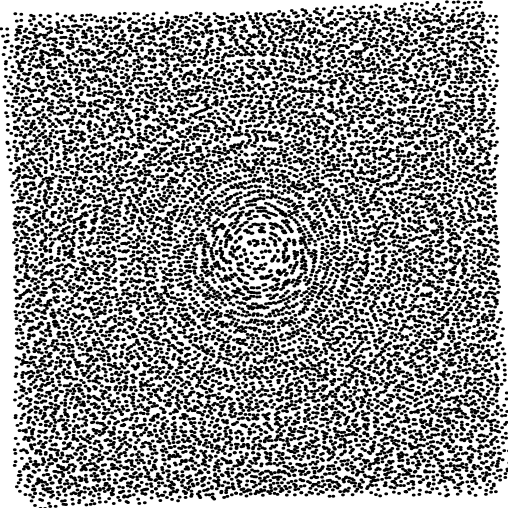

(c)

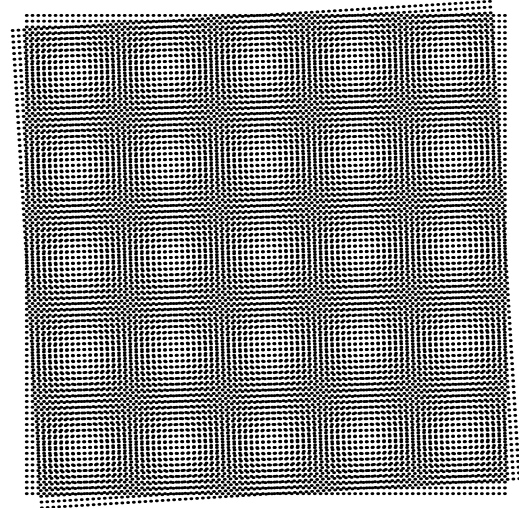

(d)

Figure 2.1(a)-(d) from the book: *The Theory of the Moiré Phenomenon Vol. II: Aperiodic Layers*, by I. Amidror, published by Springer, 2007.

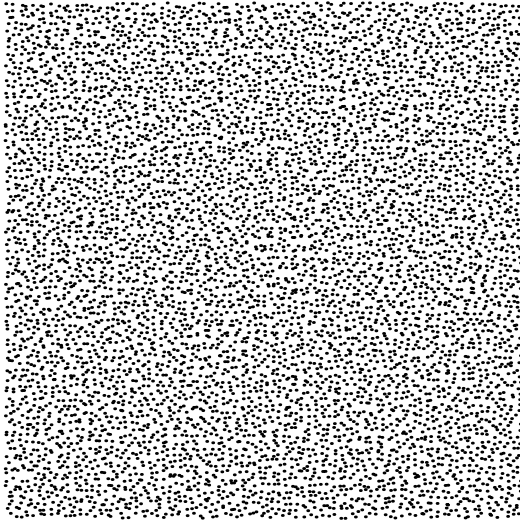

(e)

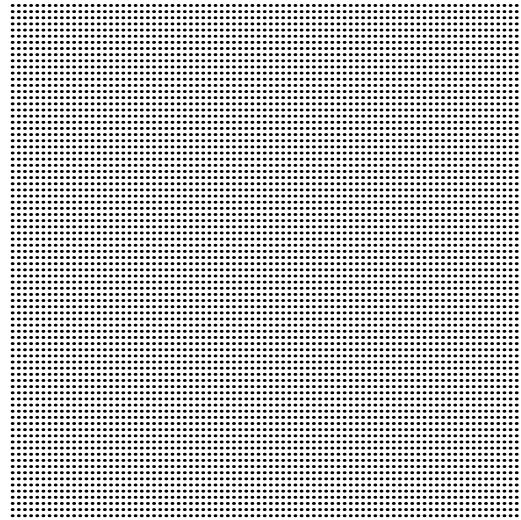

(f)

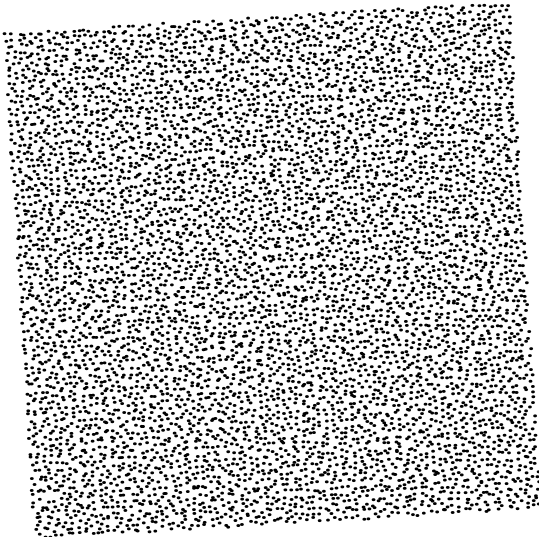

(g)

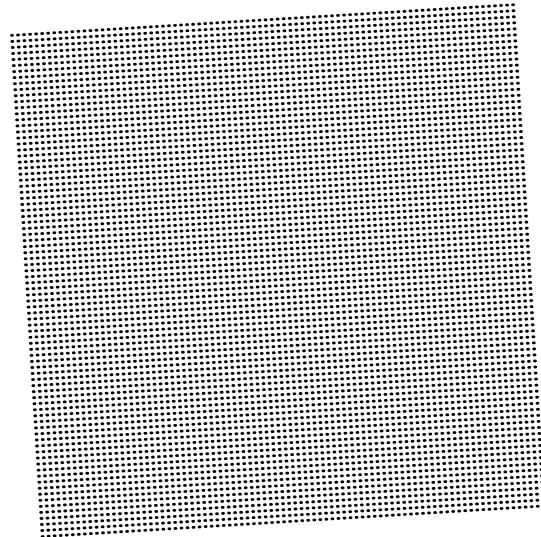

(h)

Figure 2.1(e)-(h) from the book: *The Theory of the Moiré Phenomenon*
Vol. II: Aperiodic Layers, by I. Amidror, published by Springer, 2007.

(First layer only.)

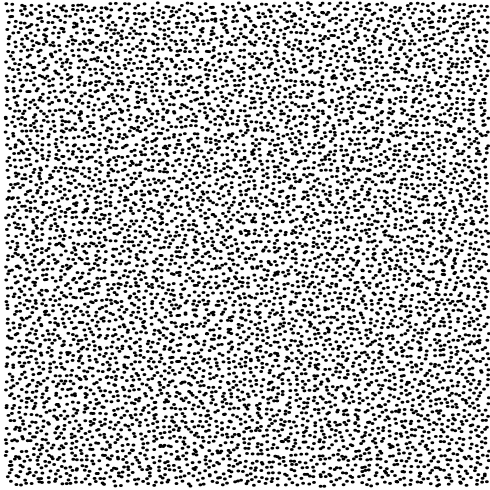

(e)

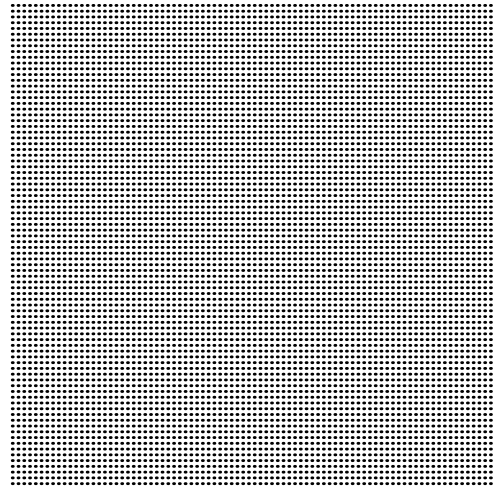

(f)

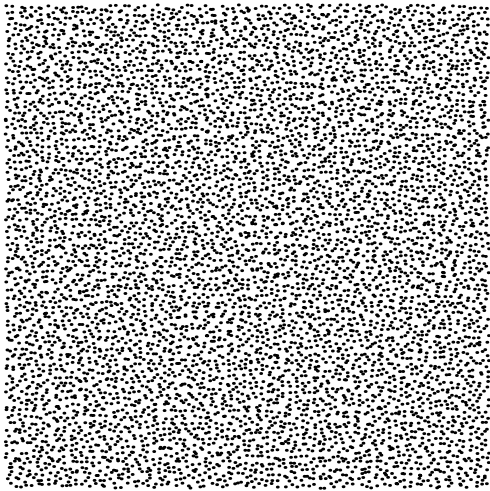

(g)

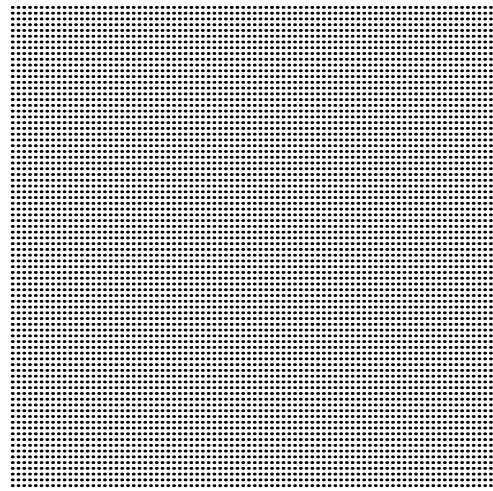

(h)

Figure 2.1(e)-(h) from the book: *The Theory of the Moiré Phenomenon Vol. II: Aperiodic Layers*, by I. Amidror, published by Springer, 2007.

(Second layer only.)

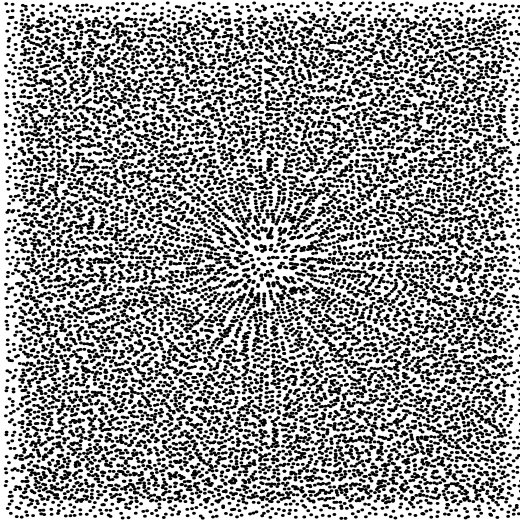

(e)

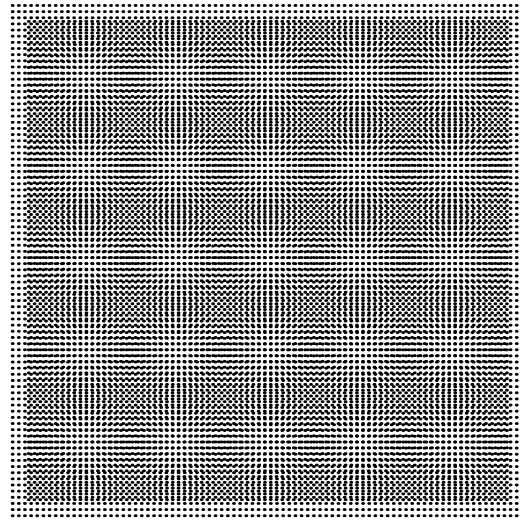

(f)

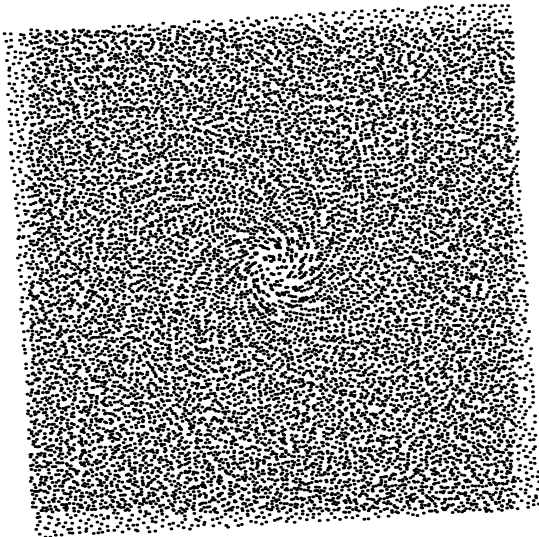

(g)

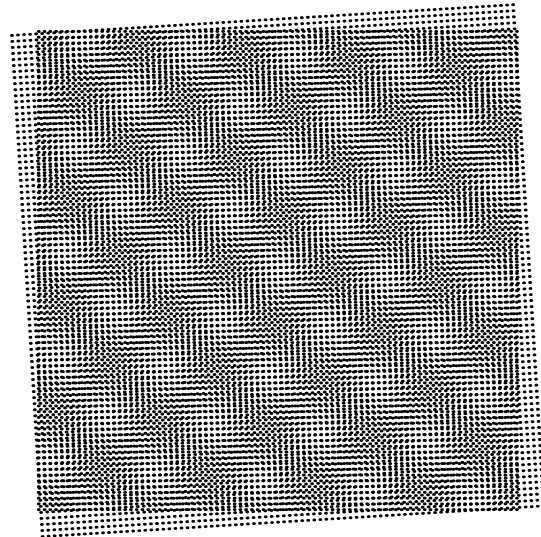

(h)

Figure 2.1(e)-(h) from the book: *The Theory of the Moiré Phenomenon Vol. II: Aperiodic Layers*, by I. Amidror, published by Springer, 2007.

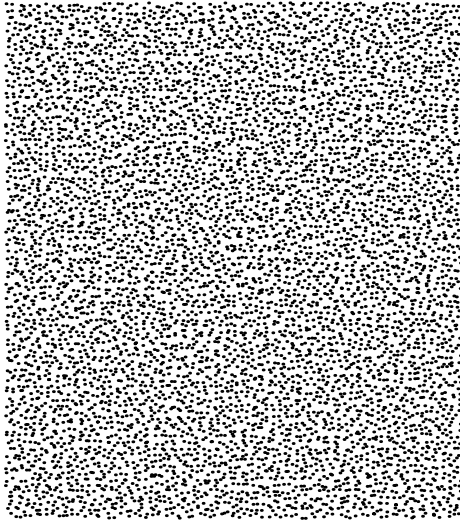

(a)

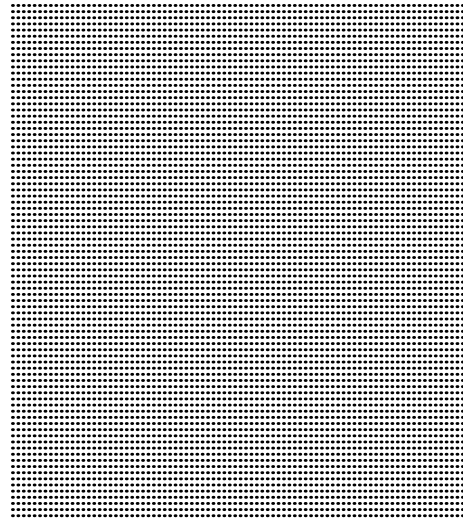

(b)

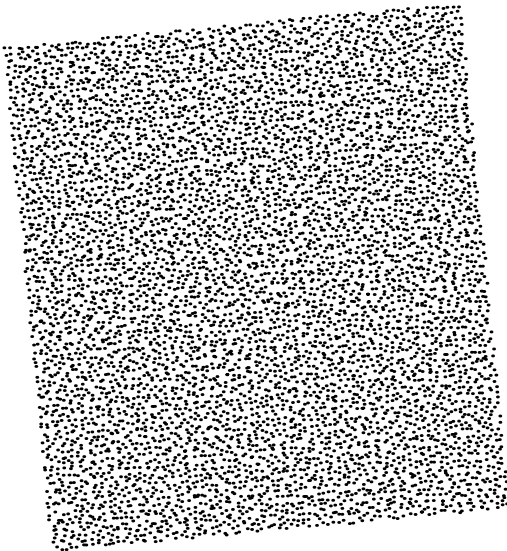

(c)

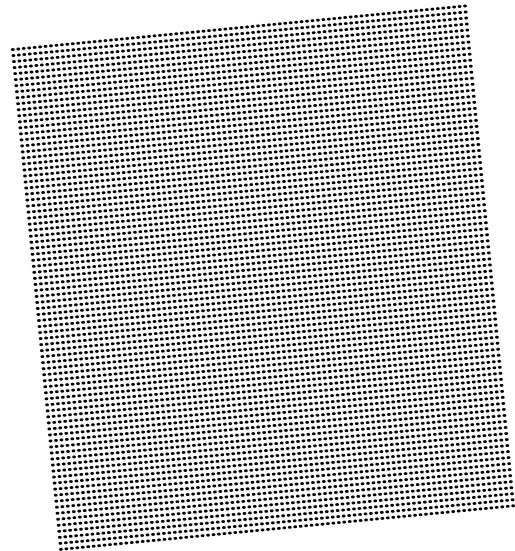

(d)

Figure 2.2(a)-(d) from the book: *The Theory of the Moiré Phenomenon*
Vol. II: Aperiodic Layers, by I. Amidror, published by Springer, 2007.

(First layer only.)

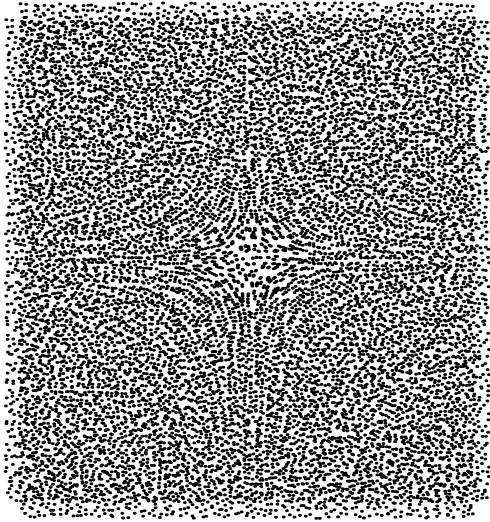

(a)

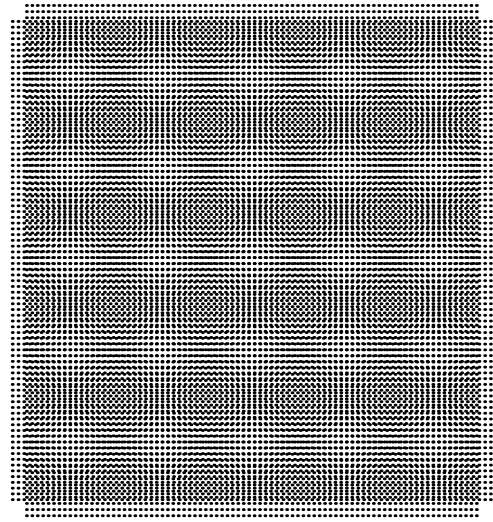

(b)

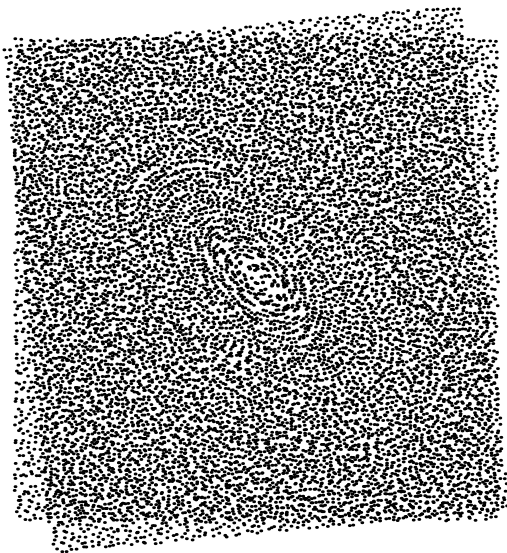

(c)

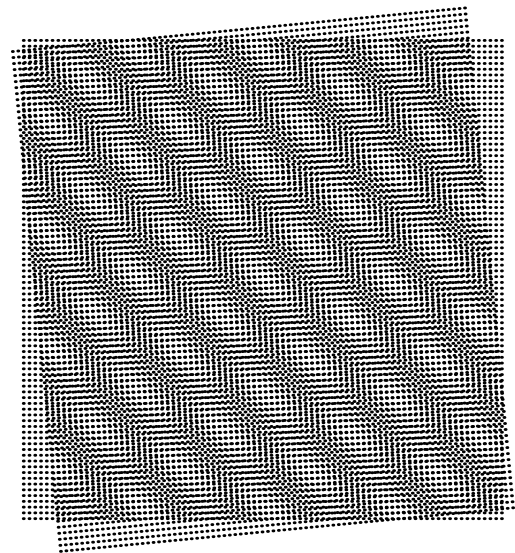

(d)

Figure 2.2(a)-(d) from the book: *The Theory of the Moiré Phenomenon Vol. II: Aperiodic Layers*, by I. Amidror, published by Springer, 2007.

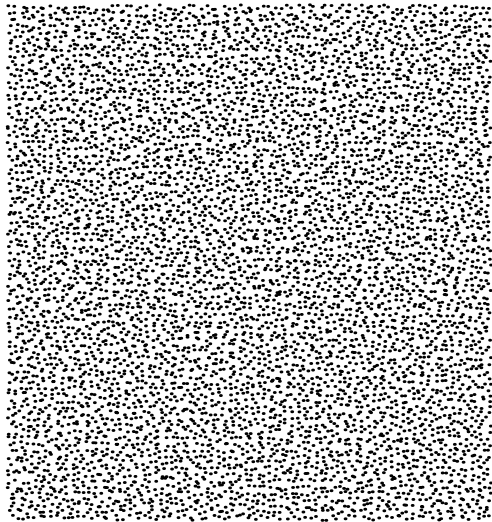

(a)

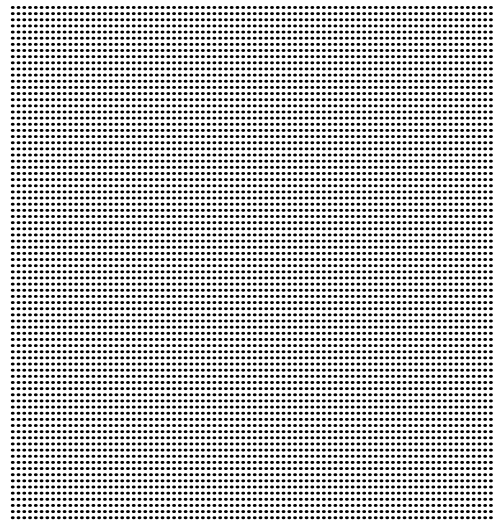

(b)

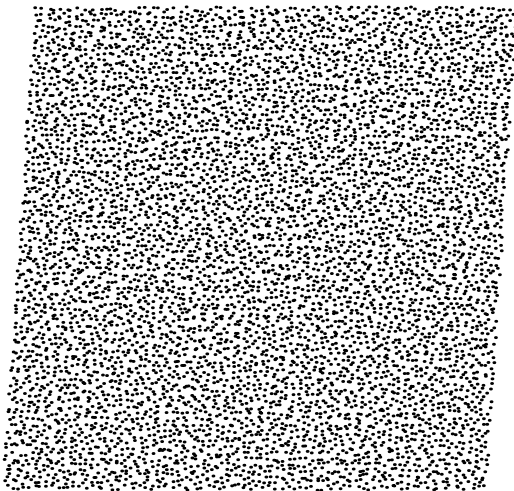

(c)

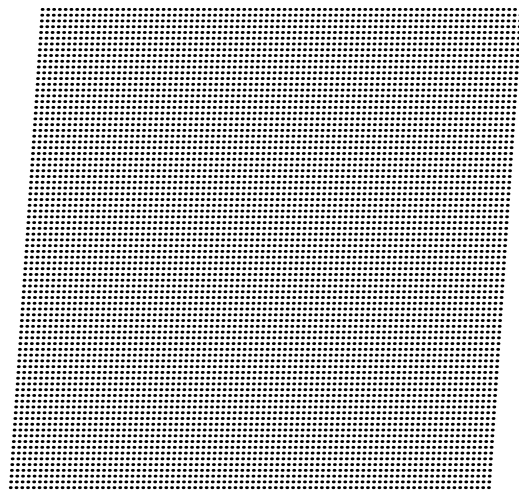

(d)

Figure 2.3(a)-(d) from the book: *The Theory of the Moiré Phenomenon Vol. II: Aperiodic Layers*, by I. Amidror, published by Springer, 2007.

(First layer only.)

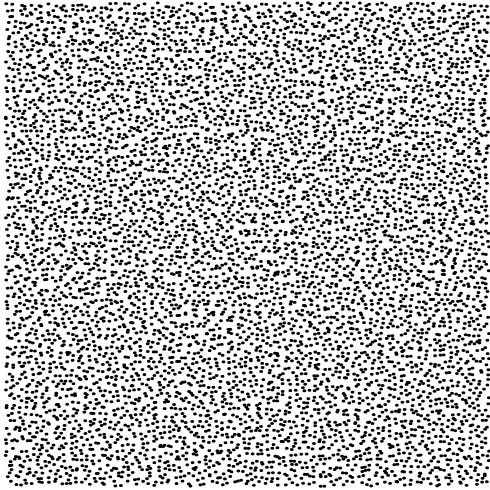

(a)

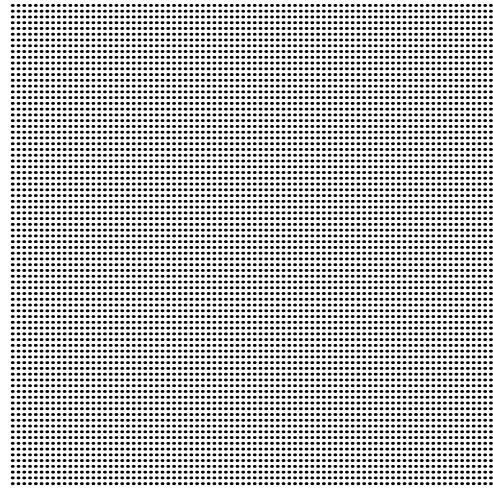

(b)

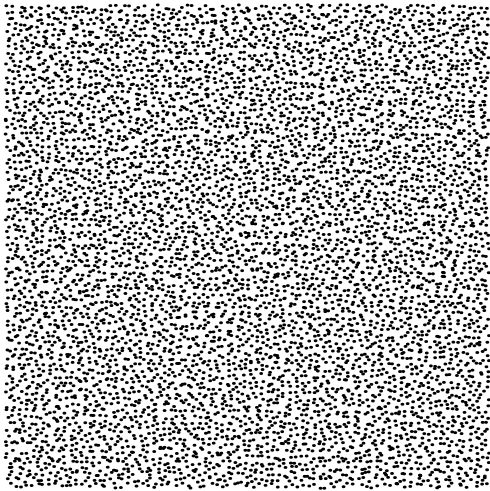

(c)

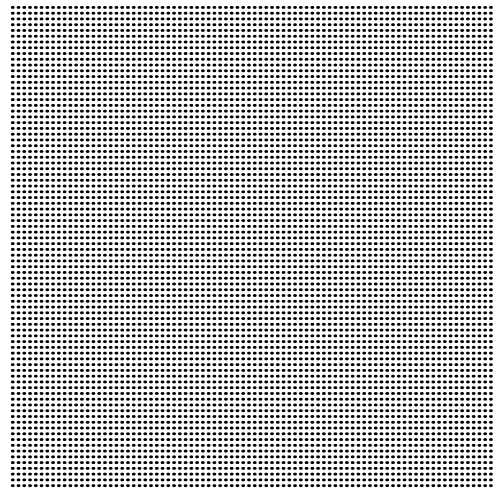

(d)

Figure 2.3(a)-(d) from the book: *The Theory of the Moiré Phenomenon Vol. II: Aperiodic Layers*, by I. Amidror, published by Springer, 2007.

(Second layer only.)

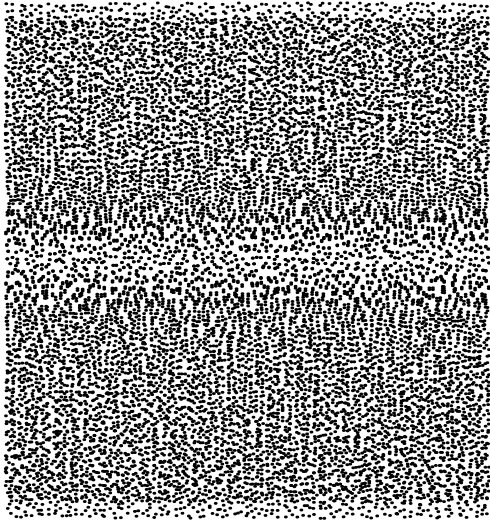

(a)

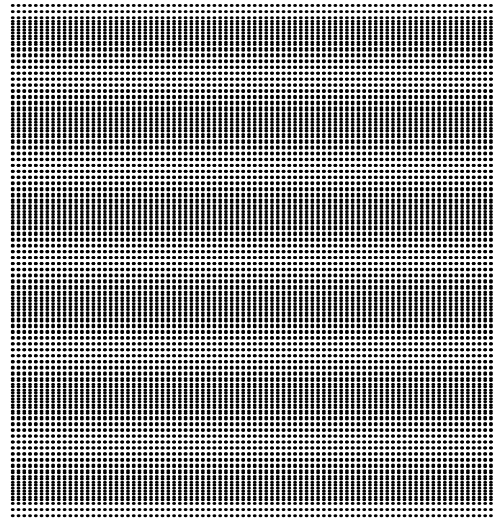

(b)

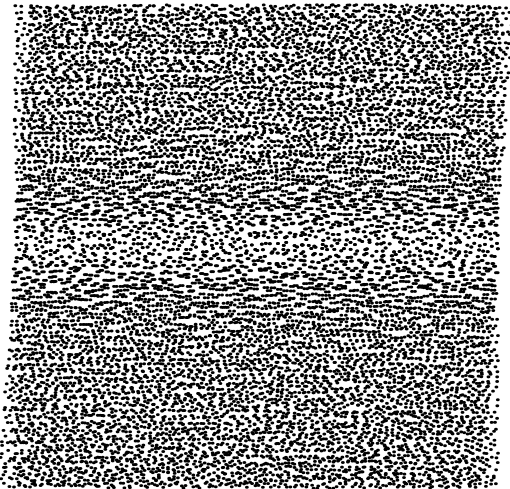

(c)

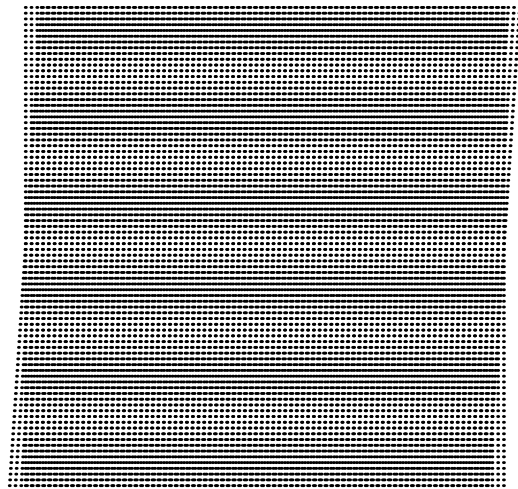

(d)

Figure 2.3(a)-(d) from the book: *The Theory of the Moiré Phenomenon Vol. II: Aperiodic Layers*, by I. Amidror, published by Springer, 2007.

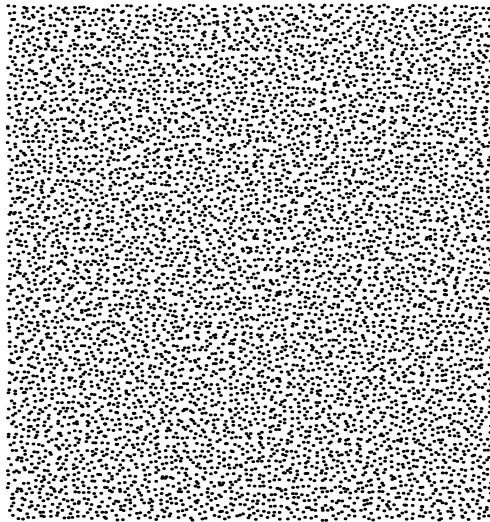

(e)

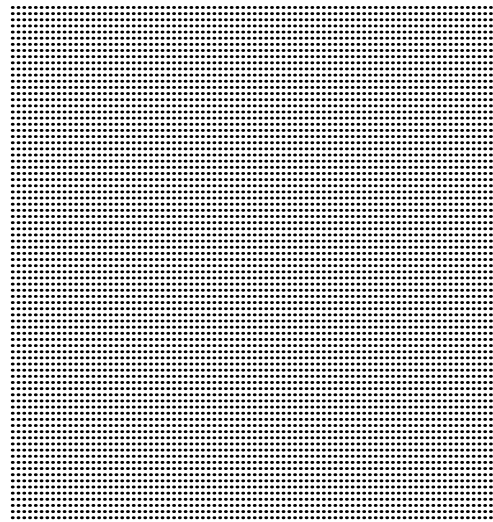

(f)

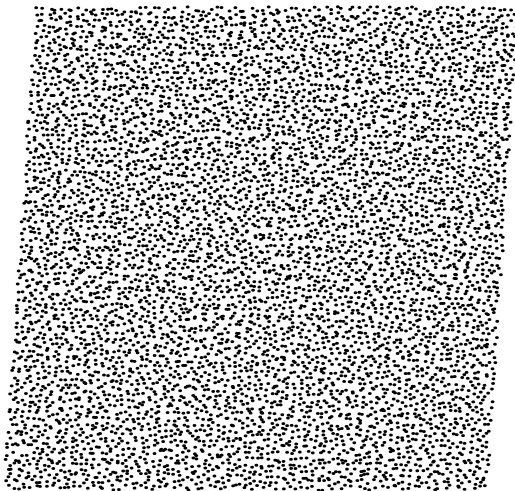

(g)

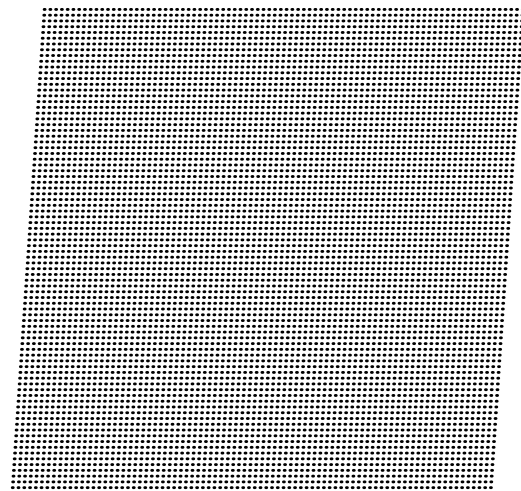

(h)

Figure 2.3(e)-(h) from the book: *The Theory of the Moiré Phenomenon*
Vol. II: Aperiodic Layers, by I. Amidror, published by Springer, 2007.

(First layer only.)

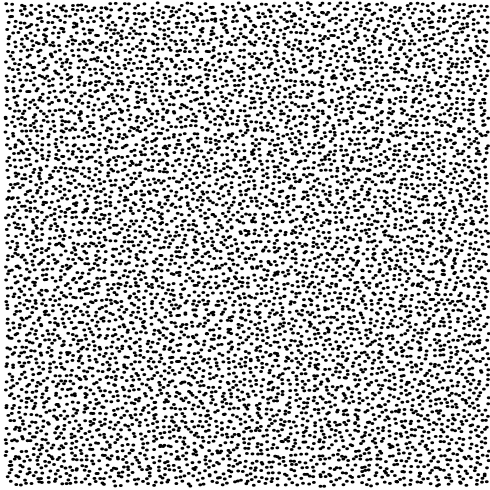

(e)

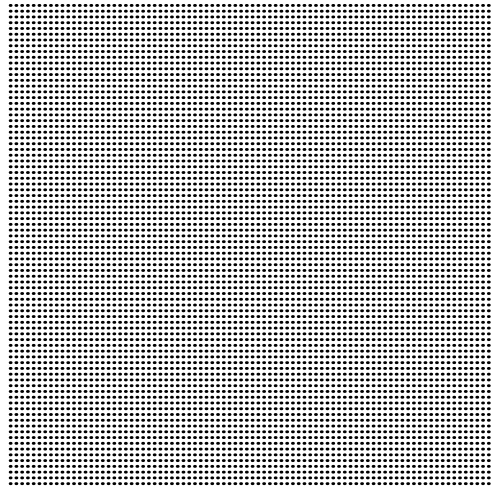

(f)

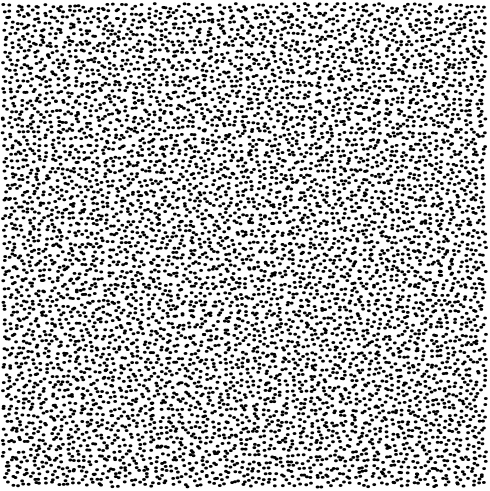

(g)

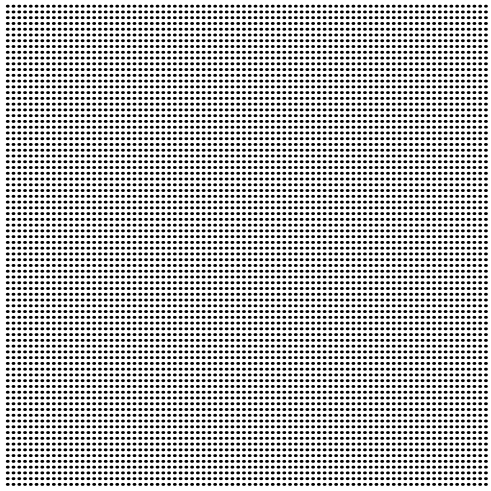

(h)

Figure 2.3(e)-(h) from the book: *The Theory of the Moiré Phenomenon Vol. II: Aperiodic Layers*, by I. Amidror, published by Springer, 2007.

(Second layer only.)

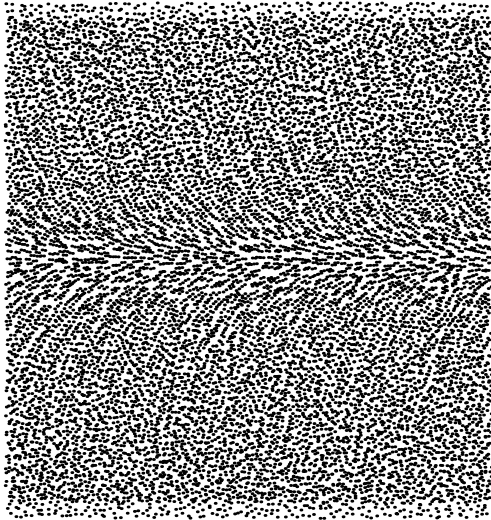

(e)

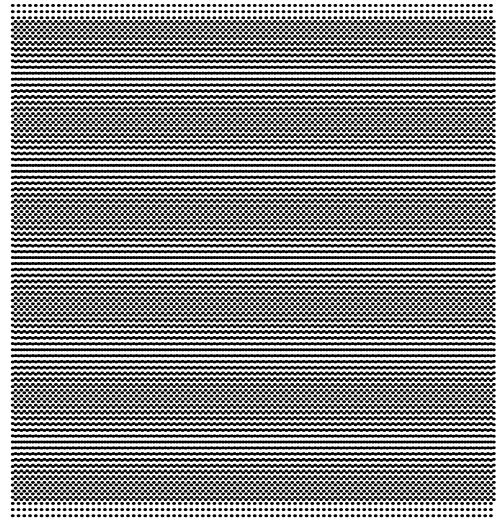

(f)

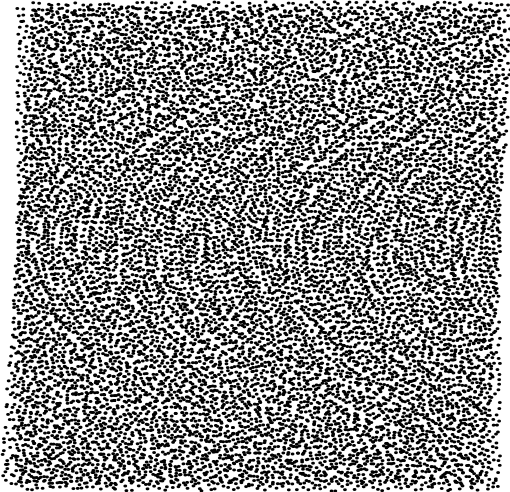

(g)

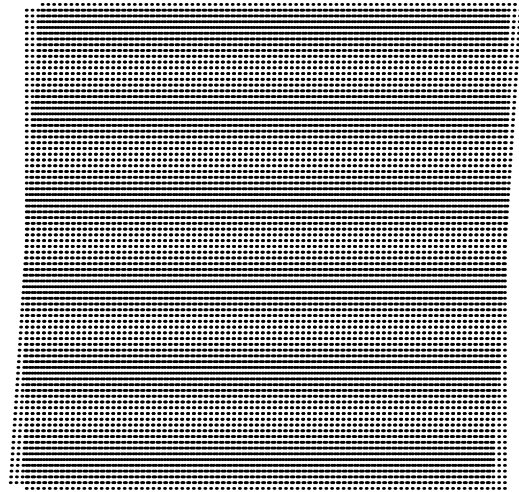

(h)

Figure 2.3(e)-(h) from the book: *The Theory of the Moiré Phenomenon Vol. II: Aperiodic Layers*, by I. Amidror, published by Springer, 2007.

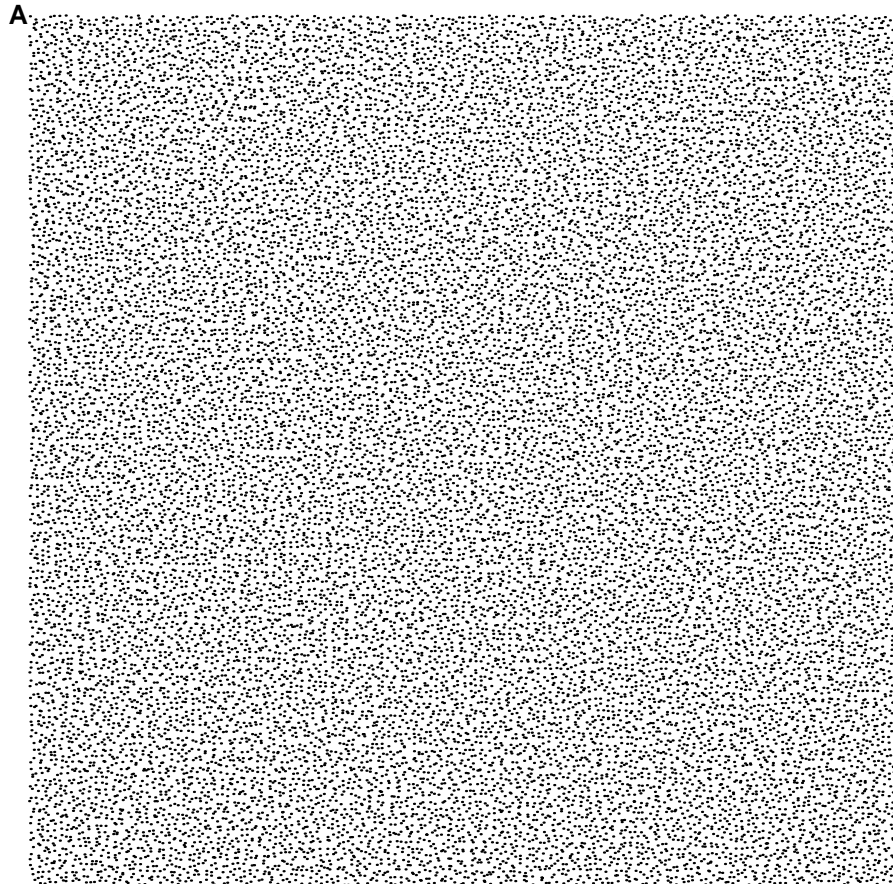

Figure 2.8 from the book: *The Theory of the Moiré Phenomenon*
Vol. II: Aperiodic Layers, by I. Amidror, published by Springer, 2007.

(First layer only.)

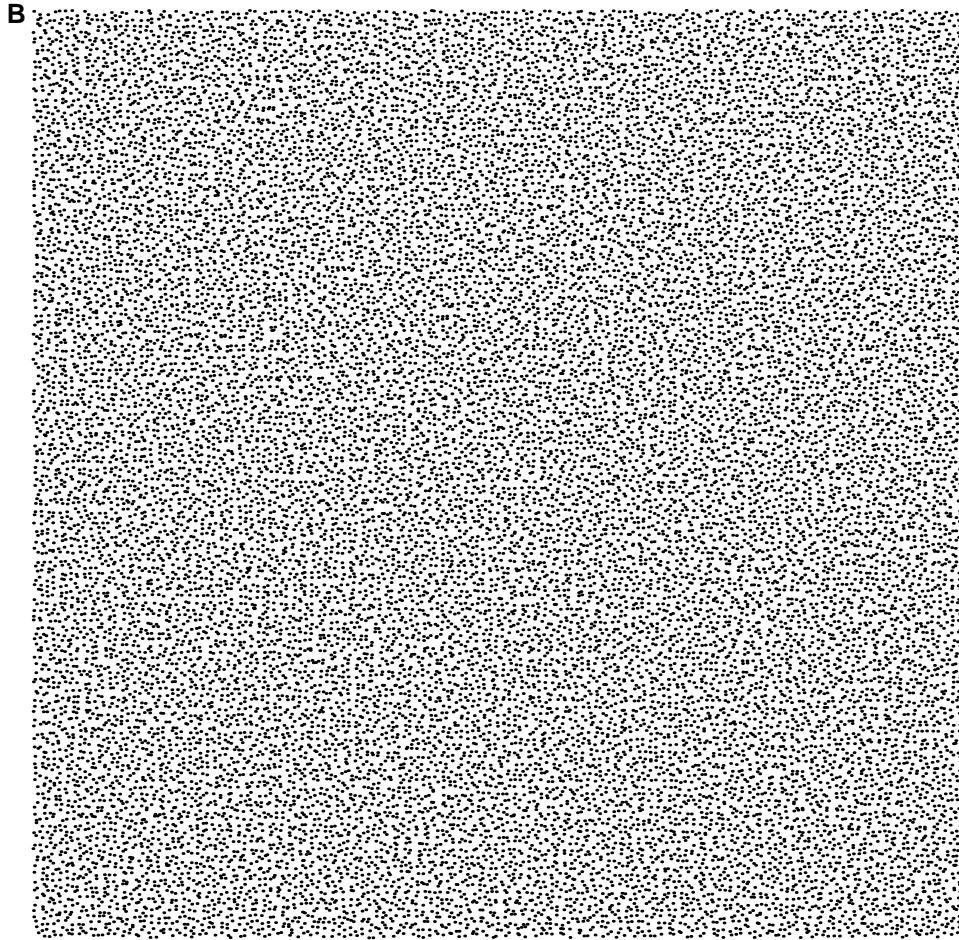

Figure 2.8 from the book: *The Theory of the Moiré Phenomenon*
Vol. II: Aperiodic Layers, by I. Amidror, published by Springer, 2007.

(Second layer only.)

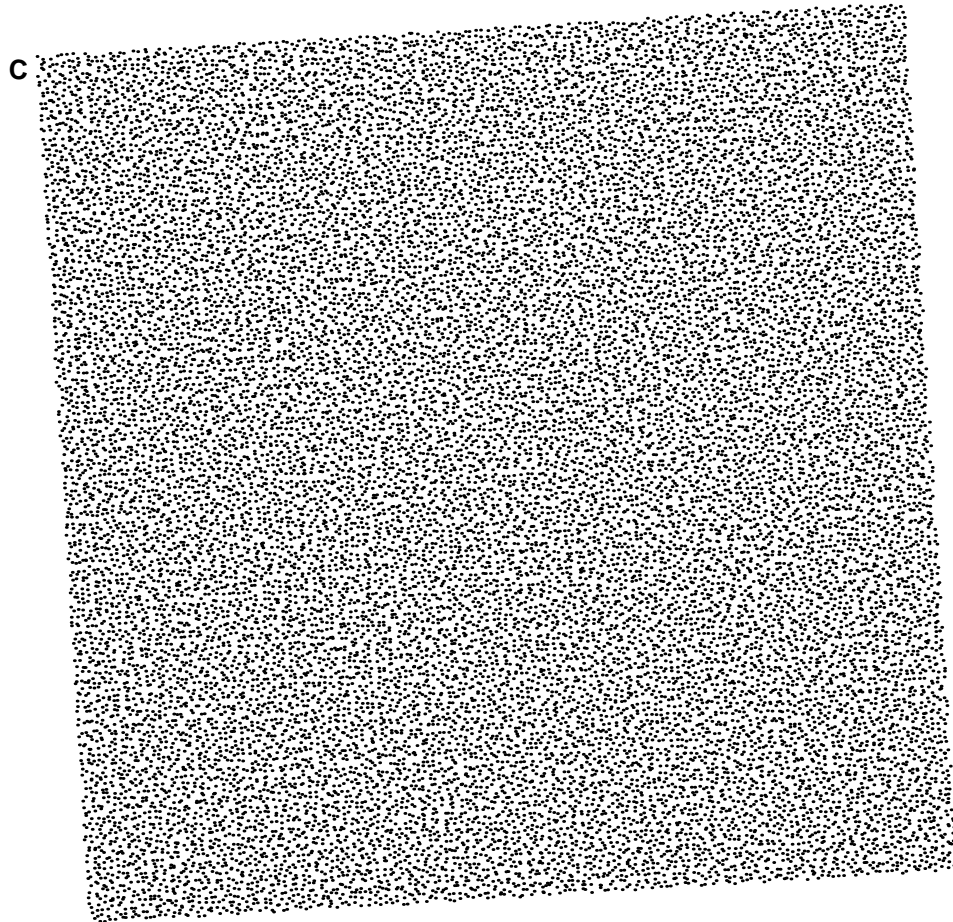

Figure 2.8 from the book: *The Theory of the Moiré Phenomenon*
Vol. II: Aperiodic Layers, by I. Amidror, published by Springer, 2007.

(Third layer only.)

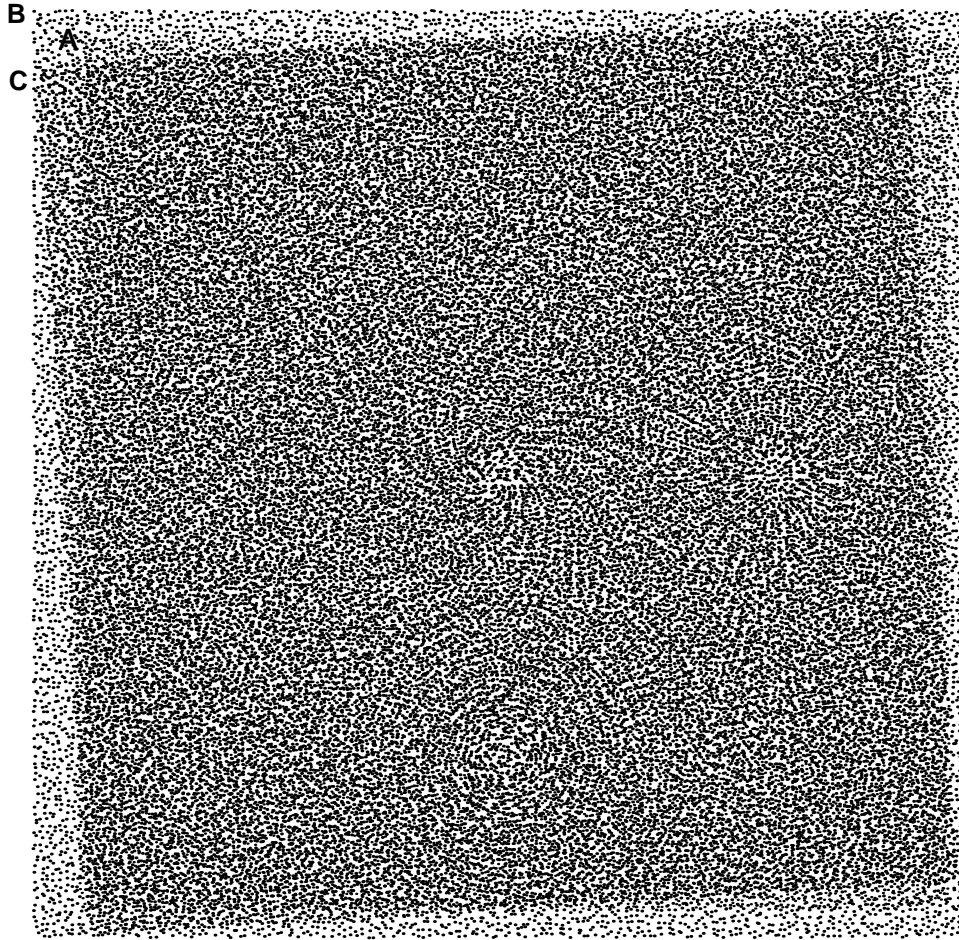
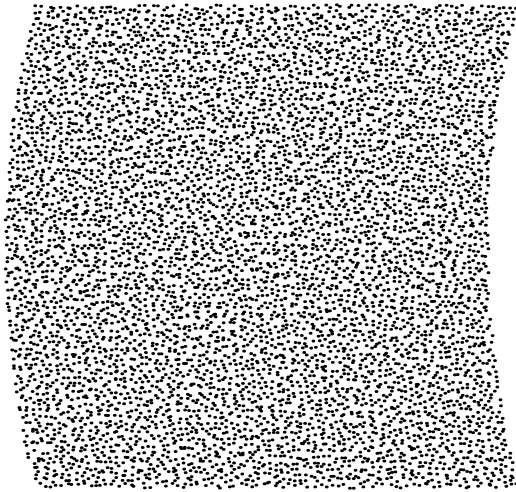
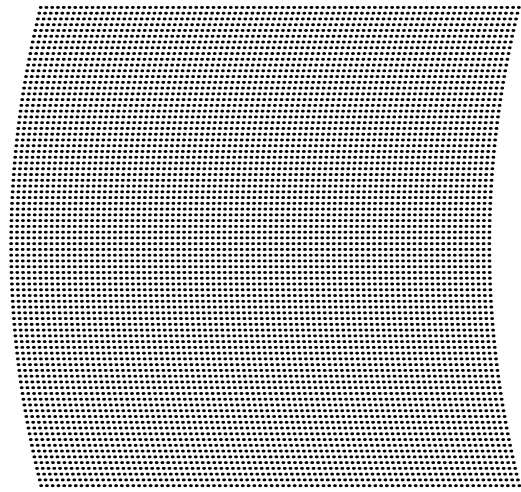

Figure 2.8 from the book: *The Theory of the Moiré Phenomenon*
Vol. II: Aperiodic Layers, by I. Amidror, published by Springer, 2007.



(a)



(b)

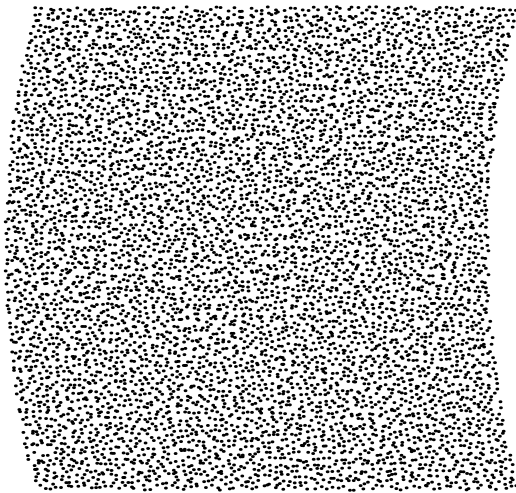

(c)

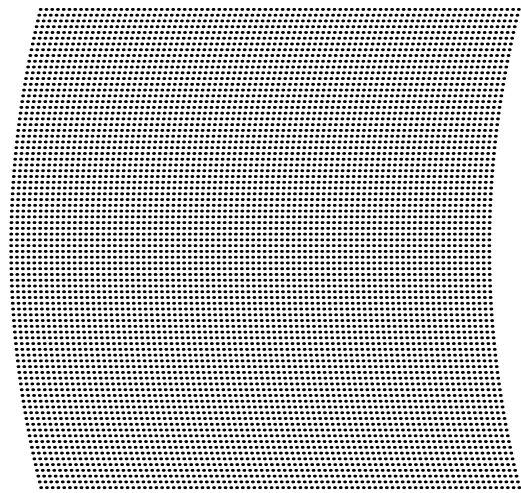

(d)

Figure 3.13(a)-(d) from the book: *The Theory of the Moiré Phenomenon*
Vol. II: Aperiodic Layers, by I. Amidror, published by Springer, 2007.

(First layer only.)

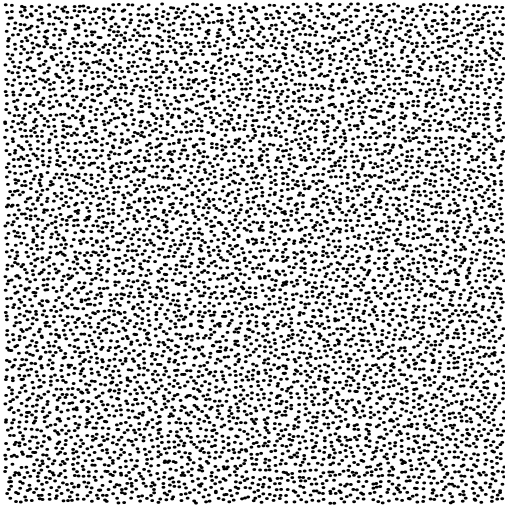

(a)

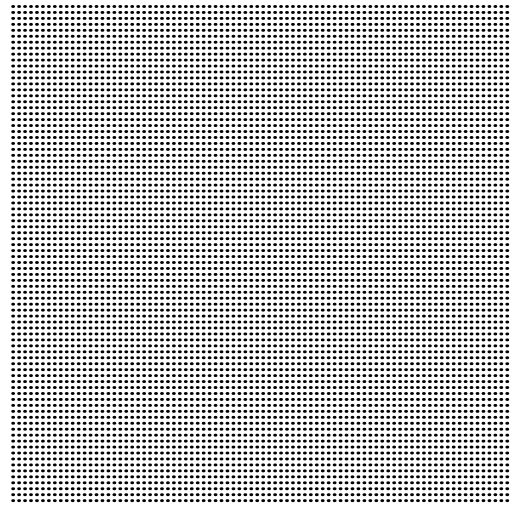

(b)

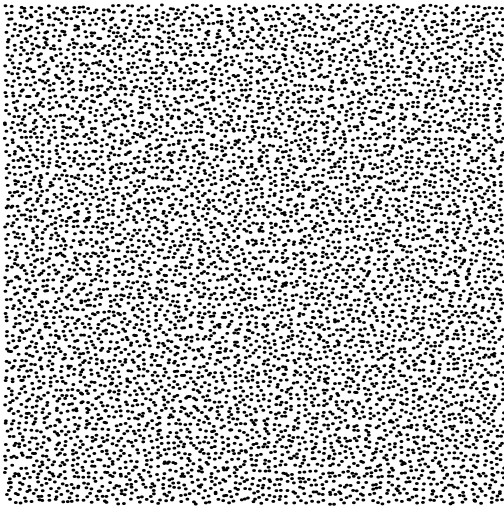

(c)

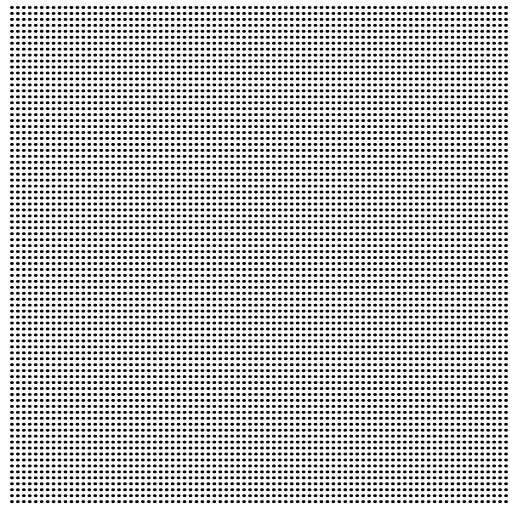

(d)

Figure 3.13(a)-(d) from the book: *The Theory of the Moiré Phenomenon Vol. II: Aperiodic Layers*, by I. Amidror, published by Springer, 2007.

(Second layer only.)

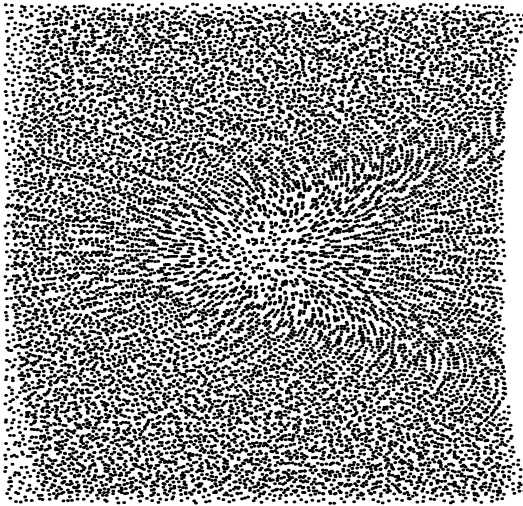

(a)

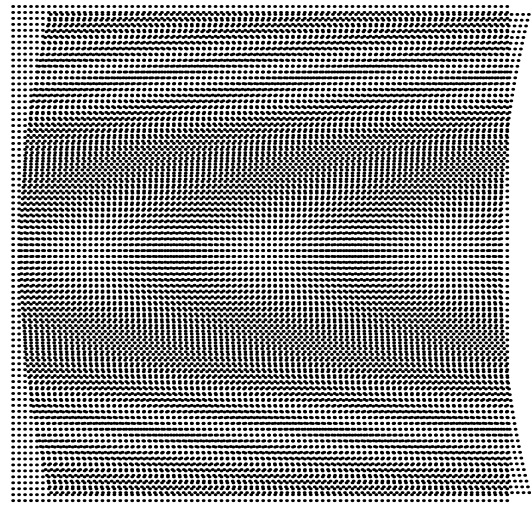

(b)

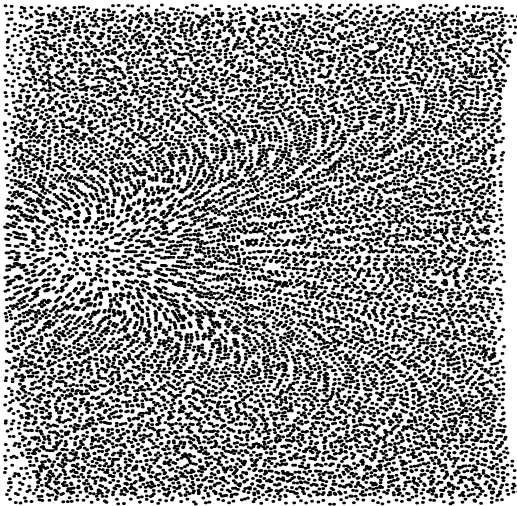

(c)

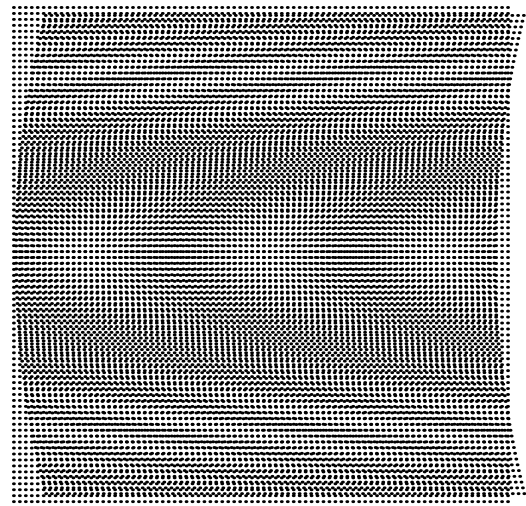

(d)

Figure 3.13(a)-(d) from the book: *The Theory of the Moiré Phenomenon Vol. II: Aperiodic Layers*, by I. Amidror, published by Springer, 2007.

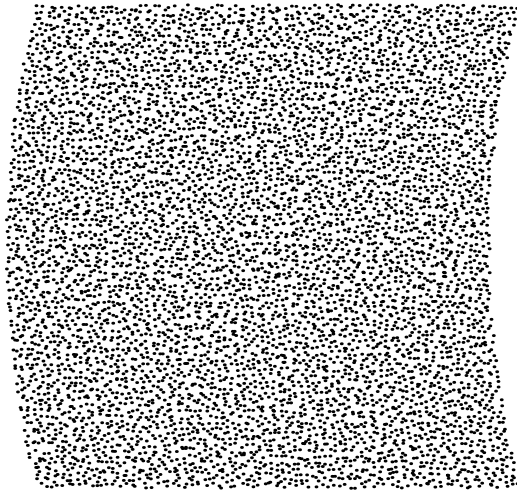

(a)

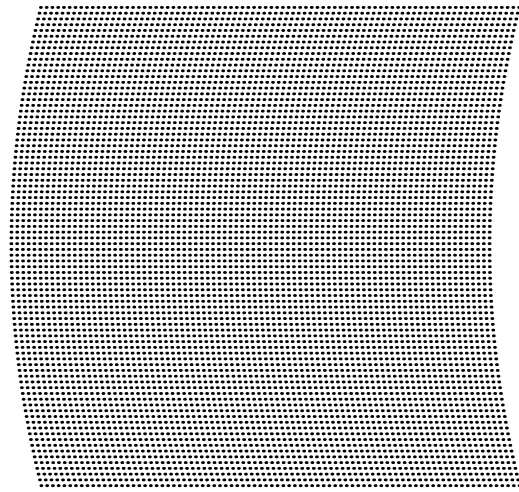

(b)

Figure 3.15(a)-(b) from the book: *The Theory of the Moiré Phenomenon*
Vol. II: Aperiodic Layers, by I. Amidror, published by Springer, 2007.

(First layer only.)

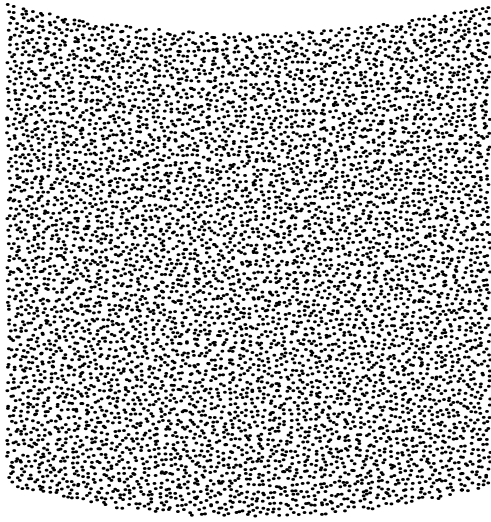

(a)

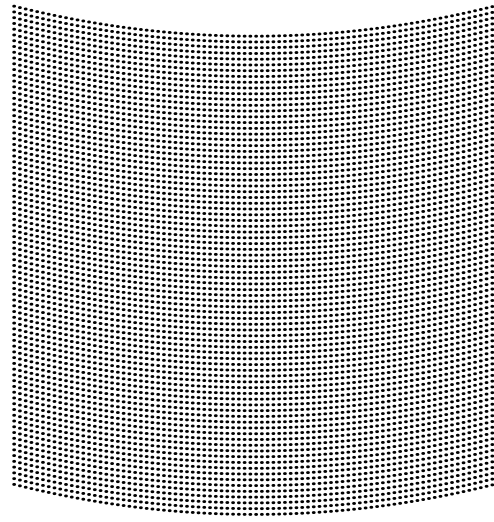

(b)

Figure 3.15(a)-(b) from the book: *The Theory of the Moiré Phenomenon Vol. II: Aperiodic Layers*, by I. Amidror, published by Springer, 2007.

(Second layer only.)

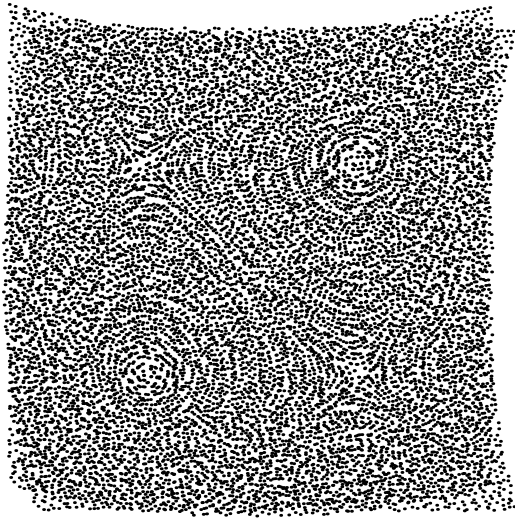

(a)

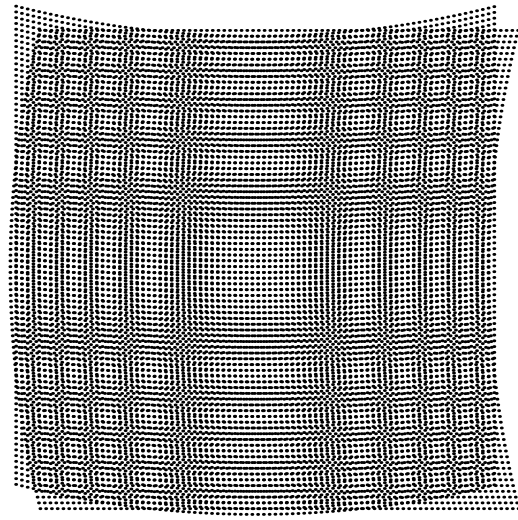

(b)

Figure 3.15(a)-(b) from the book: *The Theory of the Moiré Phenomenon Vol. II: Aperiodic Layers*, by I. Amidror, published by Springer, 2007.

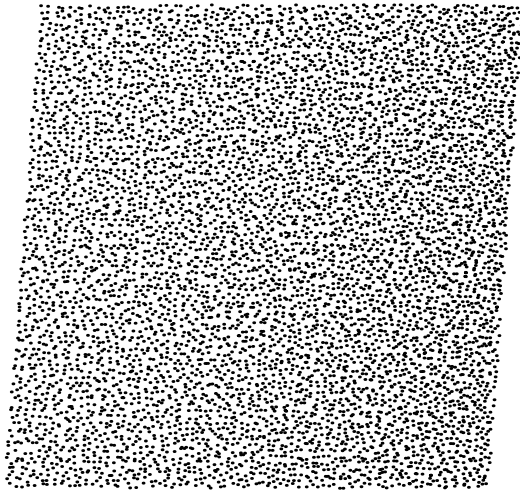

(a)

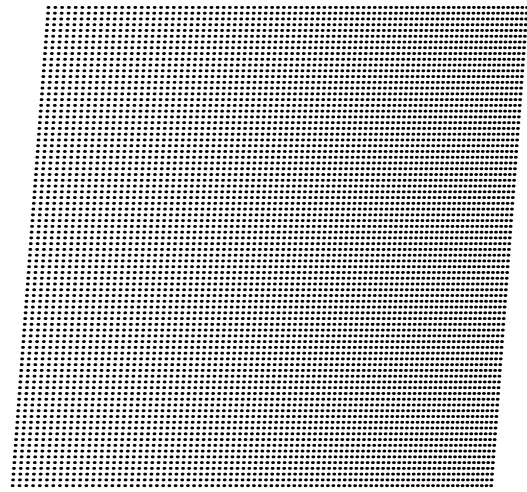

(b)

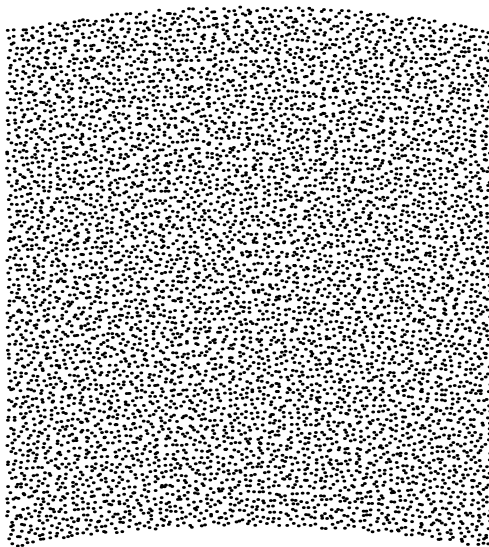

(c)

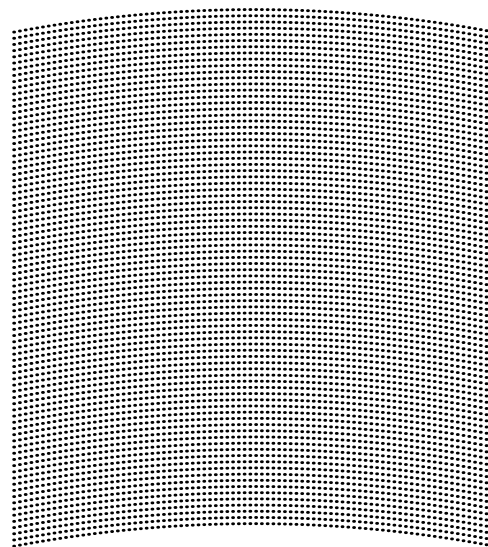

(d)

Figure 3.16(a)-(d) from the book: *The Theory of the Moiré Phenomenon Vol. II: Aperiodic Layers*, by I. Amidror, published by Springer, 2007.

(First layer only.)

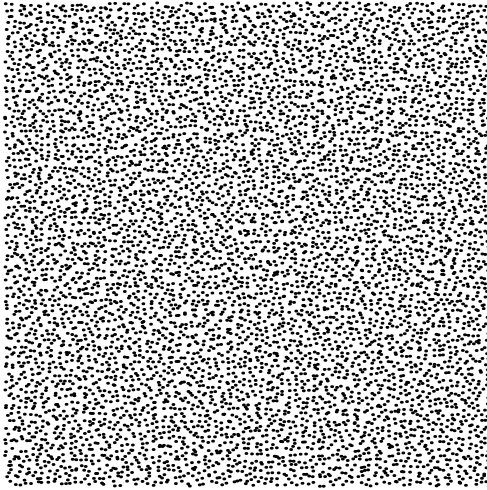

(a)

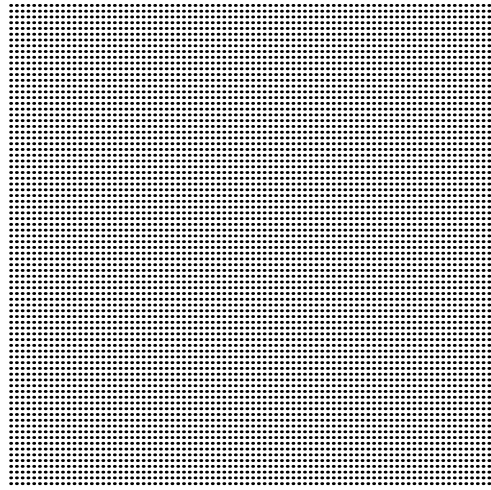

(b)

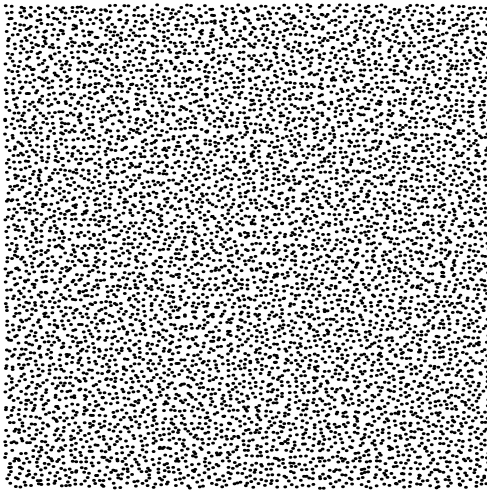

(c)

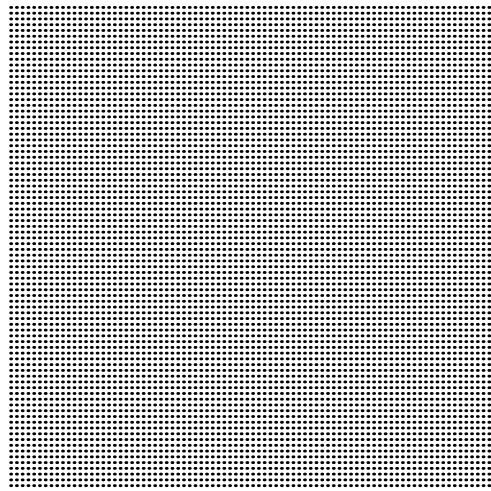

(d)

Figure 3.16(a)-(d) from the book: *The Theory of the Moiré Phenomenon Vol. II: Aperiodic Layers*, by I. Amidror, published by Springer, 2007.

(Second layer only.)

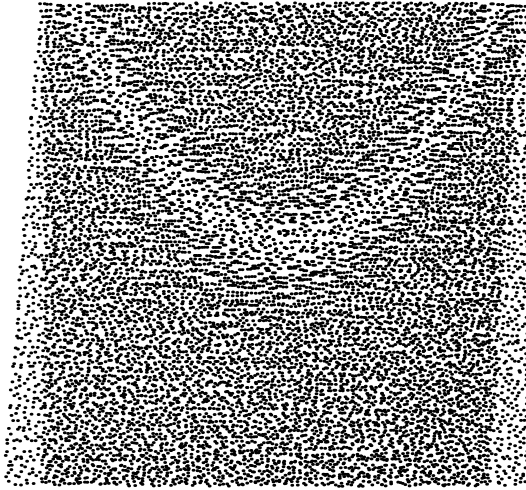

(a)

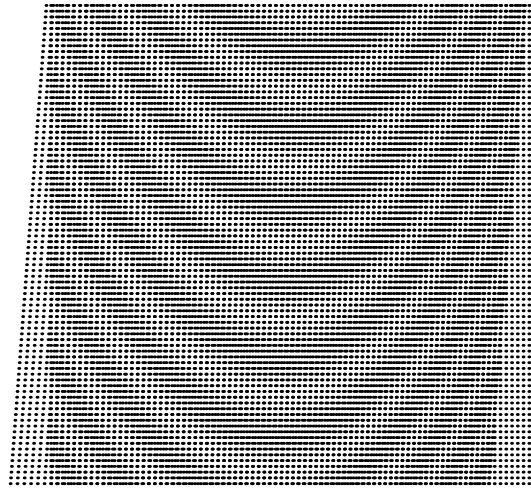

(b)

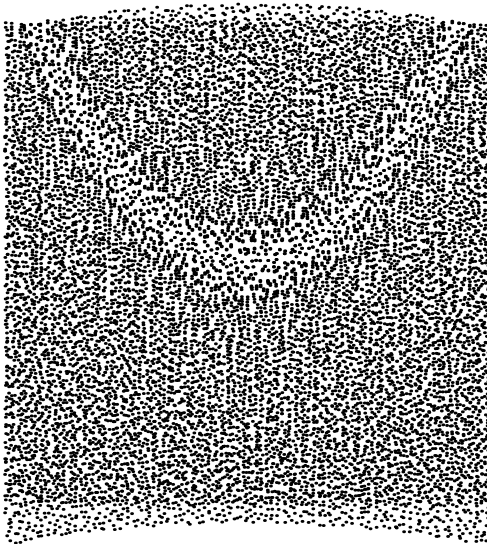

(c)

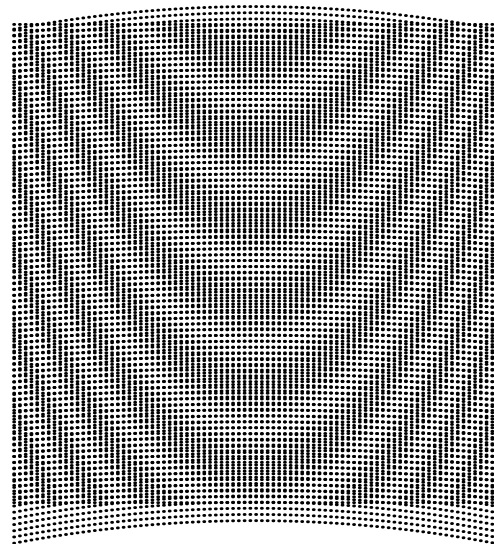

(d)

Figure 3.16(a)-(d) from the book: *The Theory of the Moiré Phenomenon Vol. II: Aperiodic Layers*, by I. Amidror, published by Springer, 2007.

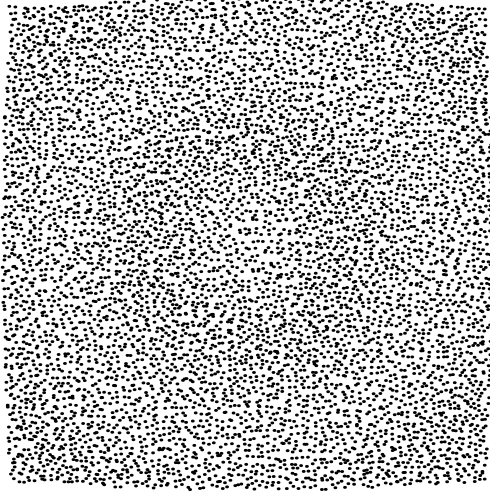

(a)

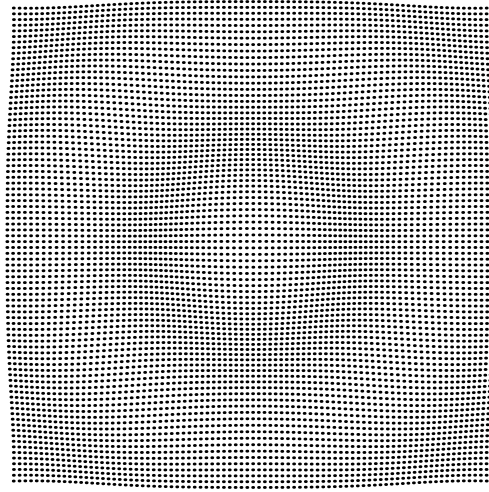

(b)

Figure 3.17(a)-(b) from the book: *The Theory of the Moiré Phenomenon Vol. II: Aperiodic Layers*, by I. Amidror, published by Springer, 2007.

(First layer only.)

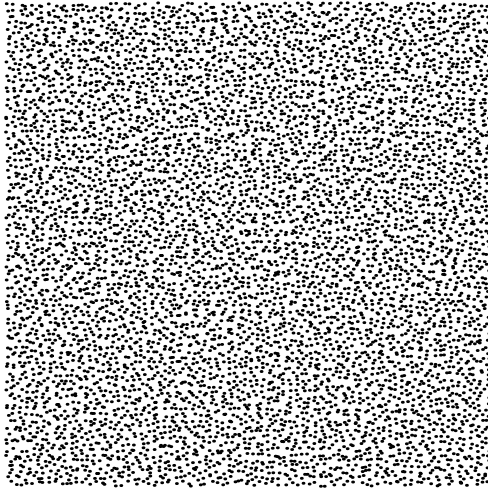

(a)

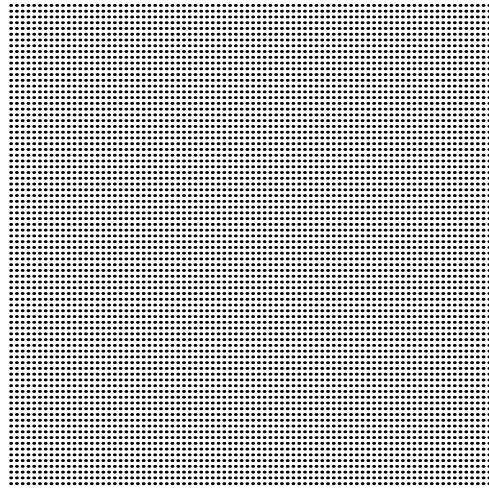

(b)

Figure 3.17(a)-(b) from the book: *The Theory of the Moiré Phenomenon Vol. II: Aperiodic Layers*, by I. Amidror, published by Springer, 2007.

(Second layer only.)

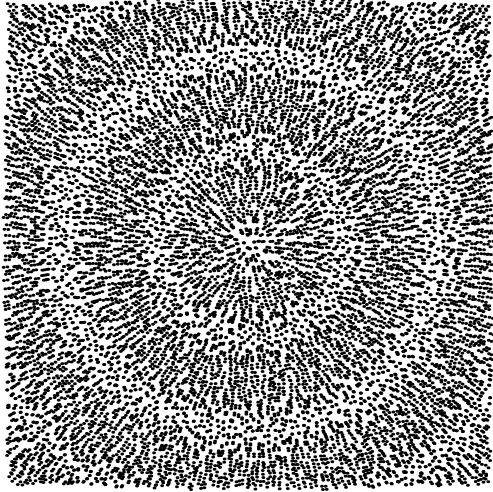

(a)

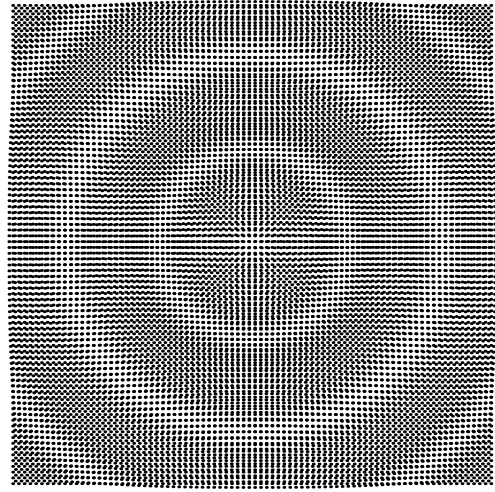

(b)

Figure 3.17(a)-(b) from the book: *The Theory of the Moiré Phenomenon Vol. II: Aperiodic Layers*, by I. Amidror, published by Springer, 2007.

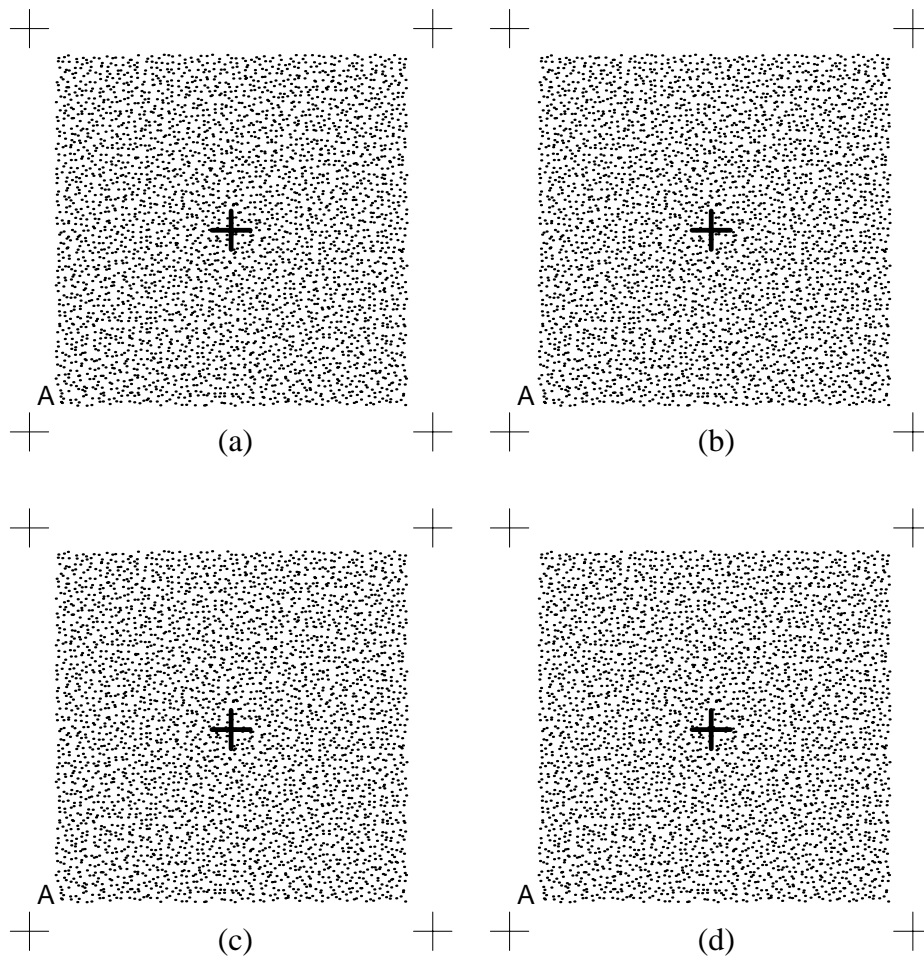

Figure 3.2(a)-(d) from the book: *The Theory of the Moiré Phenomenon Vol. II: Aperiodic Layers*, by I. Amidror, published by Springer, 2007.

(First layer only.)

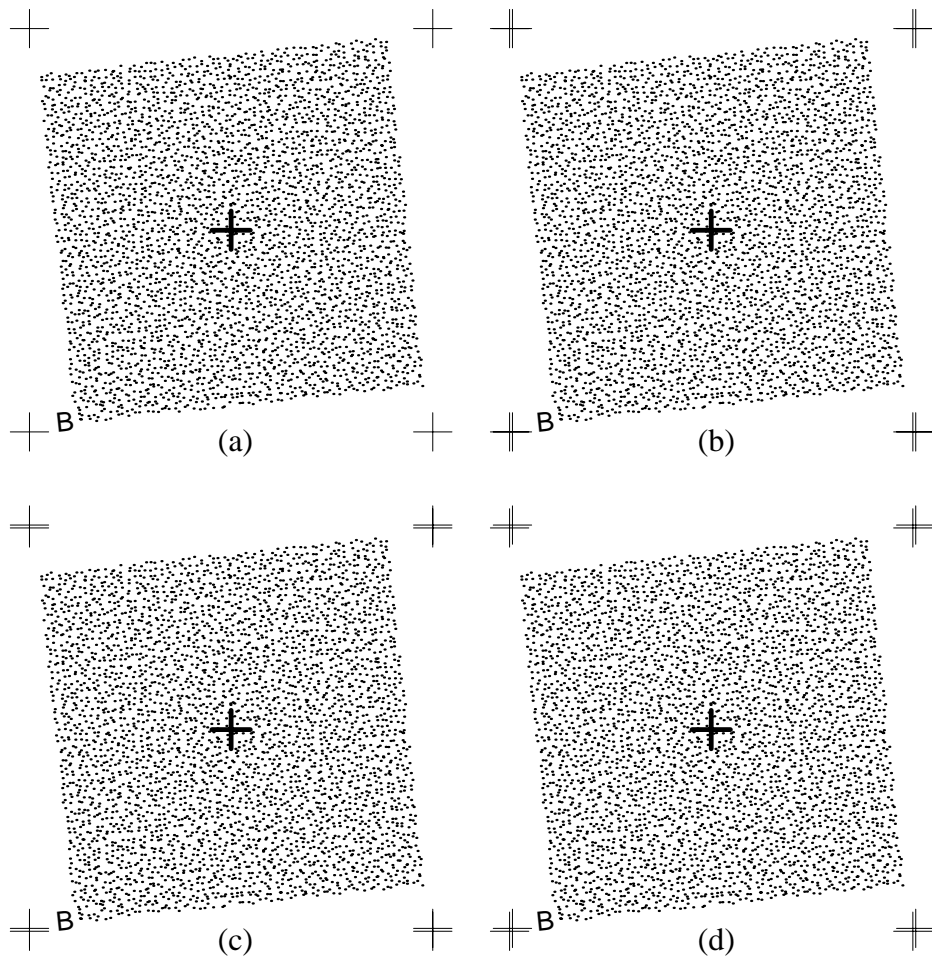

Figure 3.2(a)-(d) from the book: *The Theory of the Moiré Phenomenon Vol. II: Aperiodic Layers*, by I. Amidror, published by Springer, 2007.

(Second layer only.)

MOIRE EFFECTS THAT OCCUR IN THE SUPERPOSITION OF PERIODIC LAYERS HAVE BEEN INTENSIVELY INVESTIGATED IN THE PAST, AND THEIR MATHEMATICAL THEORY IS TODAY FULLY UNDERSTOOD. THE SAME IS TRUE FOR MOIRE EFFECTS BETWEEN REPETITIVE LAYERS I.E. BETWEEN GEOMETRIC TRANSFORMATIONS OF PERIODIC LAYERS. HOWEVER, ALTHOUGH MOIRE EFFECTS THAT OCCUR BETWEEN APERIODIC LAYERS (GLASS PATTERNS) ARE KNOWN SINCE THE 1960S, ONLY LITTLE IS KNOWN TODAY ON THEIR MATHEMATICAL BEHAVIOUR. IN THIS BOOK WE STUDY THE BEHAVIOUR OF SUCH MOIRES, AND COMPARE IT WITH ANALOGOUS RESULTS FROM THE PERIODIC CASE. WE SHOW THAT ALL CASES, PERIODIC OR NOT, OBEY THE SAME BASIC MATHEMATICAL RULES IN SPITE OF THEIR DIFFERENT VISUAL PROPERTIES. THIS LEADS US TO A UNIFIED APPROACH WHICH EXPLAINS BOTH THE BEHAVIOUR OF GLASS PATTERNS IN THE APERIODIC CASE, AND THE WELL KNOWN BEHAVIOUR OF THE MOIRE PATTERNS IN PERIODIC CASES. WE SHOW THAT ALL CASES, PERIODIC OR NOT, OBEY THE SAME BASIC MATHEMATICAL RULES IN SPITE OF THEIR DIFFERENT VISUAL PROPERTIES. THIS LEADS US TO A UNIFIED APPROACH WHICH EXPLAINS BOTH THE BEHAVIOUR OF GLASS PATTERNS IN THE APERIODIC CASE, AND THE WELL KNOWN BEHAVIOUR OF THE MOIRE PATTERNS IN PERIODIC CASES.

(a)

MOIRE EFFECTS THAT OCCUR IN THE SUPERPOSITION OF PERIODIC LAYERS HAVE BEEN INTENSIVELY INVESTIGATED IN THE PAST, AND THEIR MATHEMATICAL THEORY IS TODAY FULLY UNDERSTOOD. THE SAME IS TRUE FOR MOIRE EFFECTS BETWEEN REPETITIVE LAYERS I.E. BETWEEN GEOMETRIC TRANSFORMATIONS OF PERIODIC LAYERS. HOWEVER, ALTHOUGH MOIRE EFFECTS THAT OCCUR BETWEEN APERIODIC LAYERS (GLASS PATTERNS) ARE KNOWN SINCE THE 1960S, ONLY LITTLE IS KNOWN TODAY ON THEIR MATHEMATICAL BEHAVIOUR. IN THIS BOOK WE STUDY THE BEHAVIOUR OF SUCH MOIRES, AND COMPARE IT WITH ANALOGOUS RESULTS FROM THE PERIODIC CASE. WE SHOW THAT ALL CASES, PERIODIC OR NOT, OBEY THE SAME BASIC MATHEMATICAL RULES IN SPITE OF THEIR DIFFERENT VISUAL PROPERTIES. THIS LEADS US TO A UNIFIED APPROACH WHICH EXPLAINS BOTH THE BEHAVIOUR OF GLASS PATTERNS IN THE APERIODIC CASE, AND THE WELL KNOWN BEHAVIOUR OF THE MOIRE PATTERNS IN PERIODIC CASES. WE SHOW THAT ALL CASES, PERIODIC OR NOT, OBEY THE SAME BASIC MATHEMATICAL RULES IN SPITE OF THEIR DIFFERENT VISUAL PROPERTIES. THIS LEADS US TO A UNIFIED APPROACH WHICH EXPLAINS BOTH THE BEHAVIOUR OF GLASS PATTERNS IN THE APERIODIC CASE, AND THE WELL KNOWN BEHAVIOUR OF THE MOIRE PATTERNS IN PERIODIC CASES.

(b)

MOIRE EFFECTS THAT OCCUR IN THE SUPERPOSITION OF PERIODIC LAYERS HAVE BEEN INTENSIVELY INVESTIGATED IN THE PAST, AND THEIR MATHEMATICAL THEORY IS TODAY FULLY UNDERSTOOD. THE SAME IS TRUE FOR MOIRE EFFECTS BETWEEN REPETITIVE LAYERS I.E. BETWEEN GEOMETRIC TRANSFORMATIONS OF PERIODIC LAYERS. HOWEVER, ALTHOUGH MOIRE EFFECTS THAT OCCUR BETWEEN APERIODIC LAYERS (GLASS PATTERNS) ARE KNOWN SINCE THE 1960S, ONLY LITTLE IS KNOWN TODAY ON THEIR MATHEMATICAL BEHAVIOUR. IN THIS BOOK WE STUDY THE BEHAVIOUR OF SUCH MOIRES, AND COMPARE IT WITH ANALOGOUS RESULTS FROM THE PERIODIC CASE. WE SHOW THAT ALL CASES, PERIODIC OR NOT, OBEY THE SAME BASIC MATHEMATICAL RULES IN SPITE OF THEIR DIFFERENT VISUAL PROPERTIES. THIS LEADS US TO A UNIFIED APPROACH WHICH EXPLAINS BOTH THE BEHAVIOUR OF GLASS PATTERNS IN THE APERIODIC CASE, AND THE WELL KNOWN BEHAVIOUR OF THE MOIRE PATTERNS IN PERIODIC CASES. WE SHOW THAT ALL CASES, PERIODIC OR NOT, OBEY THE SAME BASIC MATHEMATICAL RULES IN SPITE OF THEIR DIFFERENT VISUAL PROPERTIES. THIS LEADS US TO A UNIFIED APPROACH WHICH EXPLAINS BOTH THE BEHAVIOUR OF GLASS PATTERNS IN THE APERIODIC CASE, AND THE WELL KNOWN BEHAVIOUR OF THE MOIRE PATTERNS IN PERIODIC CASES.

(c)

MOIRE EFFECTS THAT OCCUR IN THE SUPERPOSITION OF PERIODIC LAYERS HAVE BEEN INTENSIVELY INVESTIGATED IN THE PAST, AND THEIR MATHEMATICAL THEORY IS TODAY FULLY UNDERSTOOD. THE SAME IS TRUE FOR MOIRE EFFECTS BETWEEN REPETITIVE LAYERS I.E. BETWEEN GEOMETRIC TRANSFORMATIONS OF PERIODIC LAYERS. HOWEVER, ALTHOUGH MOIRE EFFECTS THAT OCCUR BETWEEN APERIODIC LAYERS (GLASS PATTERNS) ARE KNOWN SINCE THE 1960S, ONLY LITTLE IS KNOWN TODAY ON THEIR MATHEMATICAL BEHAVIOUR. IN THIS BOOK WE STUDY THE BEHAVIOUR OF SUCH MOIRES, AND COMPARE IT WITH ANALOGOUS RESULTS FROM THE PERIODIC CASE. WE SHOW THAT ALL CASES, PERIODIC OR NOT, OBEY THE SAME BASIC MATHEMATICAL RULES IN SPITE OF THEIR DIFFERENT VISUAL PROPERTIES. THIS LEADS US TO A UNIFIED APPROACH WHICH EXPLAINS BOTH THE BEHAVIOUR OF GLASS PATTERNS IN THE APERIODIC CASE, AND THE WELL KNOWN BEHAVIOUR OF THE MOIRE PATTERNS IN PERIODIC CASES. WE SHOW THAT ALL CASES, PERIODIC OR NOT, OBEY THE SAME BASIC MATHEMATICAL RULES IN SPITE OF THEIR DIFFERENT VISUAL PROPERTIES. THIS LEADS US TO A UNIFIED APPROACH WHICH EXPLAINS BOTH THE BEHAVIOUR OF GLASS PATTERNS IN THE APERIODIC CASE, AND THE WELL KNOWN BEHAVIOUR OF THE MOIRE PATTERNS IN PERIODIC CASES.

(d)

Figure 3.23 from the book: *The Theory of the Moiré Phenomenon*
Vol. II: Aperiodic Layers, by I. Amidror, published by Springer, 2007.

(First layer only.)

MOIRE EFFECTS THAT OCCUR IN THE SUPERPOSITION OF PERIODIC LAYERS HAVE BEEN INTENSIVELY INVESTIGATED IN THE PAST, AND THEIR MATHEMATICAL THEORY IS TODAY FULLY UNDERSTOOD. THE SAME IS TRUE FOR MOIRE EFFECTS BETWEEN REPETITIVE LAYERS I.E. BETWEEN GEOMETRIC TRANSFORMATIONS OF PERIODIC LAYERS. HOWEVER, ALTHOUGH MOIRE EFFECTS THAT OCCUR BETWEEN APERIODIC LAYERS (GLASS PATTERNS) ARE KNOWN SINCE THE 1960S, ONLY LITTLE IS KNOWN TODAY ON THEIR MATHEMATICAL BEHAVIOUR. IN THIS BOOK WE STUDY THE BEHAVIOUR OF SUCH MOIRE PATTERNS, AND COMPARE IT WITH ANALOGOUS RESULTS FROM THE PERIODIC CASE. WE SHOW THAT ALL CASES, PERIODIC OR NOT, OBEY THE SAME BASIC MATHEMATICAL RULES IN SPITE OF THEIR DIFFERENT VISUAL PROPERTIES. THIS LEADS US TO A UNIFIED APPROACH WHICH EXPLAINS BOTH THE BEHAVIOUR OF GLASS PATTERNS IN THE APERIODIC CASE, AND THE WELL KNOWN BEHAVIOUR OF THE MOIRE PATTERNS IN PERIODIC CASES. WE SHOW THAT ALL CASES, PERIODIC OR NOT, OBEY THE SAME BASIC MATHEMATICAL RULES IN SPITE OF THEIR DIFFERENT VISUAL PROPERTIES. THIS LEADS US TO A UNIFIED APPROACH WHICH EXPLAINS BOTH THE BEHAVIOUR OF GLASS PATTERNS IN THE APERIODIC CASE, AND THE WELL KNOWN BEHAVIOUR OF THE MOIRE PATTERNS IN PERIODIC CASES.

(a)

(b)

MOIRE EFFECTS THAT OCCUR IN THE SUPERPOSITION OF PERIODIC LAYERS HAVE BEEN INTENSIVELY INVESTIGATED IN THE PAST, AND THEIR MATHEMATICAL THEORY IS TODAY FULLY UNDERSTOOD. THE SAME IS TRUE FOR MOIRE EFFECTS BETWEEN REPETITIVE LAYERS I.E. BETWEEN GEOMETRIC TRANSFORMATIONS OF PERIODIC LAYERS. HOWEVER, ALTHOUGH MOIRE EFFECTS THAT OCCUR BETWEEN APERIODIC LAYERS (GLASS PATTERNS) ARE KNOWN SINCE THE 1960S, ONLY LITTLE IS KNOWN TODAY ON THEIR MATHEMATICAL BEHAVIOUR. IN THIS BOOK WE STUDY THE BEHAVIOUR OF SUCH MOIRE PATTERNS, AND COMPARE IT WITH ANALOGOUS RESULTS FROM THE PERIODIC CASE. WE SHOW THAT ALL CASES, PERIODIC OR NOT, OBEY THE SAME BASIC MATHEMATICAL RULES IN SPITE OF THEIR DIFFERENT VISUAL PROPERTIES. THIS LEADS US TO A UNIFIED APPROACH WHICH EXPLAINS BOTH THE BEHAVIOUR OF GLASS PATTERNS IN THE APERIODIC CASE, AND THE WELL KNOWN BEHAVIOUR OF THE MOIRE PATTERNS IN PERIODIC CASES. WE SHOW THAT ALL CASES, PERIODIC OR NOT, OBEY THE SAME BASIC MATHEMATICAL RULES IN SPITE OF THEIR DIFFERENT VISUAL PROPERTIES. THIS LEADS US TO A UNIFIED APPROACH WHICH EXPLAINS BOTH THE BEHAVIOUR OF GLASS PATTERNS IN THE APERIODIC CASE, AND THE WELL KNOWN BEHAVIOUR OF THE MOIRE PATTERNS IN PERIODIC CASES.

(c)

MOIRE EFFECTS THAT OCCUR IN THE SUPERPOSITION OF PERIODIC LAYERS HAVE BEEN INTENSIVELY INVESTIGATED IN THE PAST, AND THEIR MATHEMATICAL THEORY IS TODAY FULLY UNDERSTOOD. THE SAME IS TRUE FOR MOIRE EFFECTS BETWEEN REPETITIVE LAYERS I.E. BETWEEN GEOMETRIC TRANSFORMATIONS OF PERIODIC LAYERS. HOWEVER, ALTHOUGH MOIRE EFFECTS THAT OCCUR BETWEEN APERIODIC LAYERS (GLASS PATTERNS) ARE KNOWN SINCE THE 1960S, ONLY LITTLE IS KNOWN TODAY ON THEIR MATHEMATICAL BEHAVIOUR. IN THIS BOOK WE STUDY THE BEHAVIOUR OF SUCH MOIRE PATTERNS, AND COMPARE IT WITH ANALOGOUS RESULTS FROM THE PERIODIC CASE. WE SHOW THAT ALL CASES, PERIODIC OR NOT, OBEY THE SAME BASIC MATHEMATICAL RULES IN SPITE OF THEIR DIFFERENT VISUAL PROPERTIES. THIS LEADS US TO A UNIFIED APPROACH WHICH EXPLAINS BOTH THE BEHAVIOUR OF GLASS PATTERNS IN THE APERIODIC CASE, AND THE WELL KNOWN BEHAVIOUR OF THE MOIRE PATTERNS IN PERIODIC CASES. WE SHOW THAT ALL CASES, PERIODIC OR NOT, OBEY THE SAME BASIC MATHEMATICAL RULES IN SPITE OF THEIR DIFFERENT VISUAL PROPERTIES. THIS LEADS US TO A UNIFIED APPROACH WHICH EXPLAINS BOTH THE BEHAVIOUR OF GLASS PATTERNS IN THE APERIODIC CASE, AND THE WELL KNOWN BEHAVIOUR OF THE MOIRE PATTERNS IN PERIODIC CASES.

(d)

Figure 3.23 from the book: *The Theory of the Moiré Phenomenon Vol. II: Aperiodic Layers*, by I. Amidror, published by Springer, 2007.

(Second layer only.)

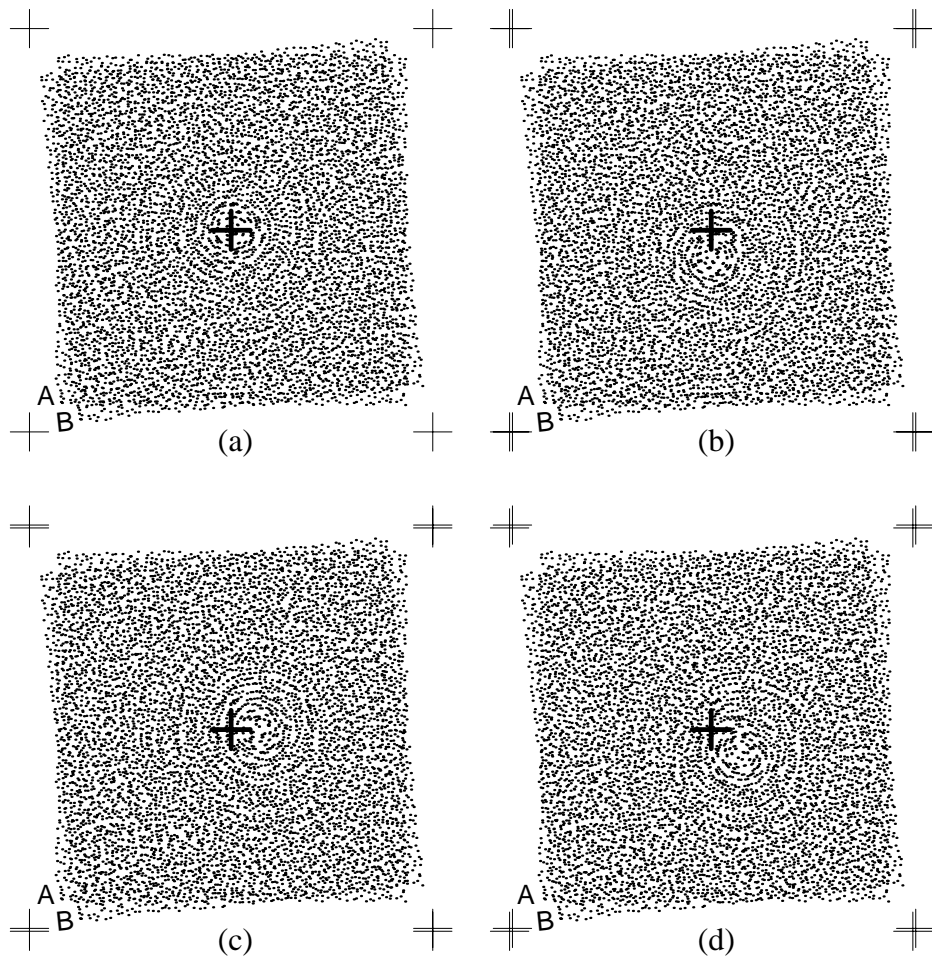

Figure 3.2(a)-(d) from the book: *The Theory of the Moiré Phenomenon Vol. II: Aperiodic Layers*, by I. Amidror, published by Springer, 2007.

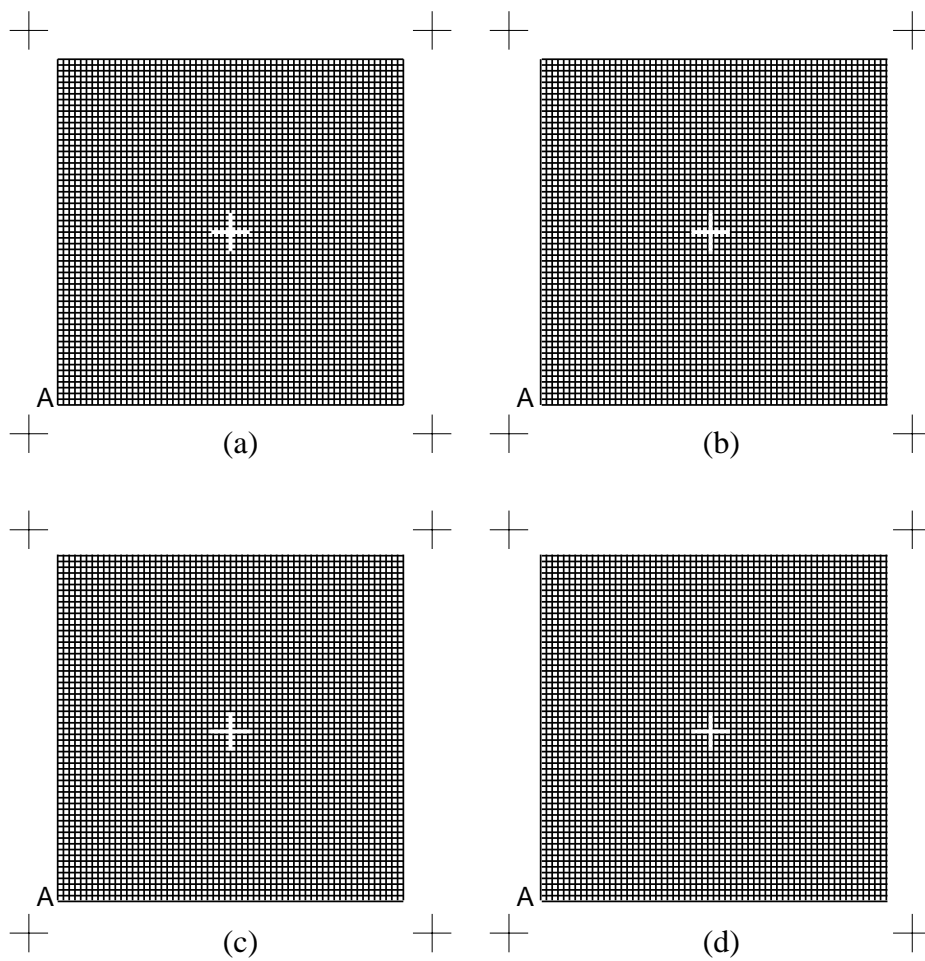

Figure 3.3(a)-(d) from the book: *The Theory of the Moiré Phenomenon Vol. II: Aperiodic Layers*, by I. Amidror, published by Springer, 2007.

(First layer only.)

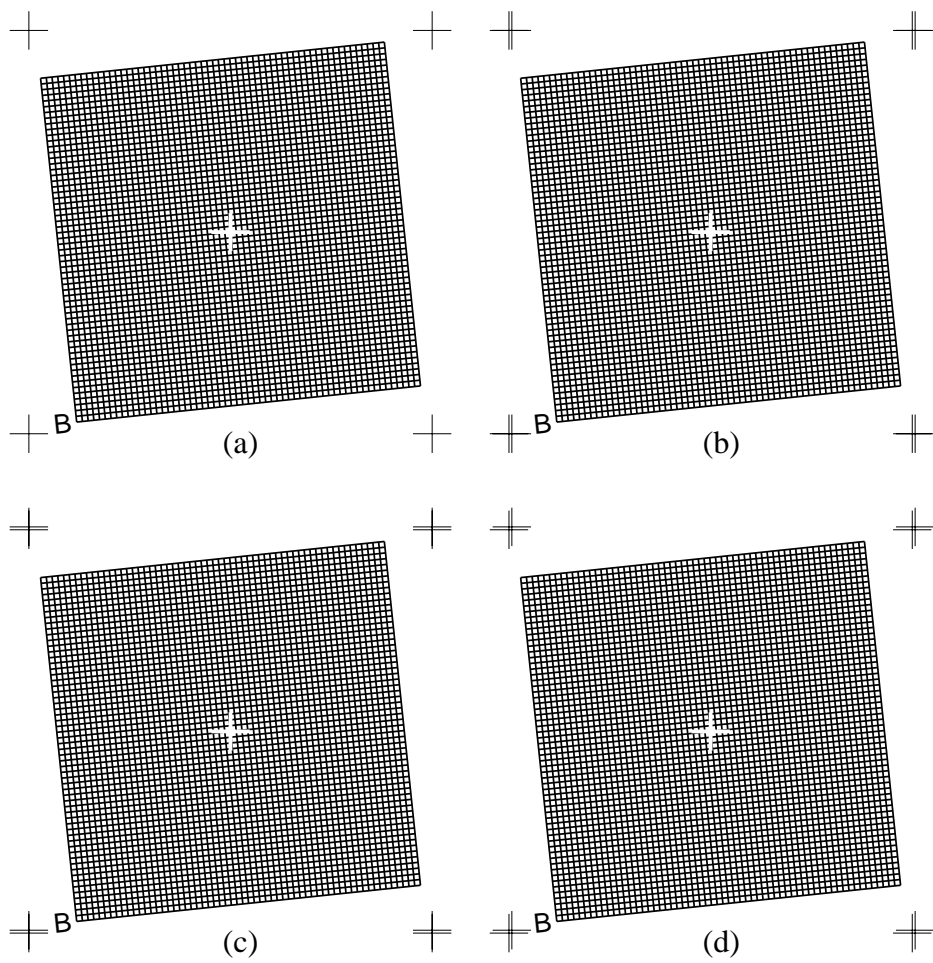

Figure 3.3(a)-(d) from the book: *The Theory of the Moiré Phenomenon Vol. II: Aperiodic Layers*, by I. Amidror, published by Springer, 2007.

(Second layer only.)

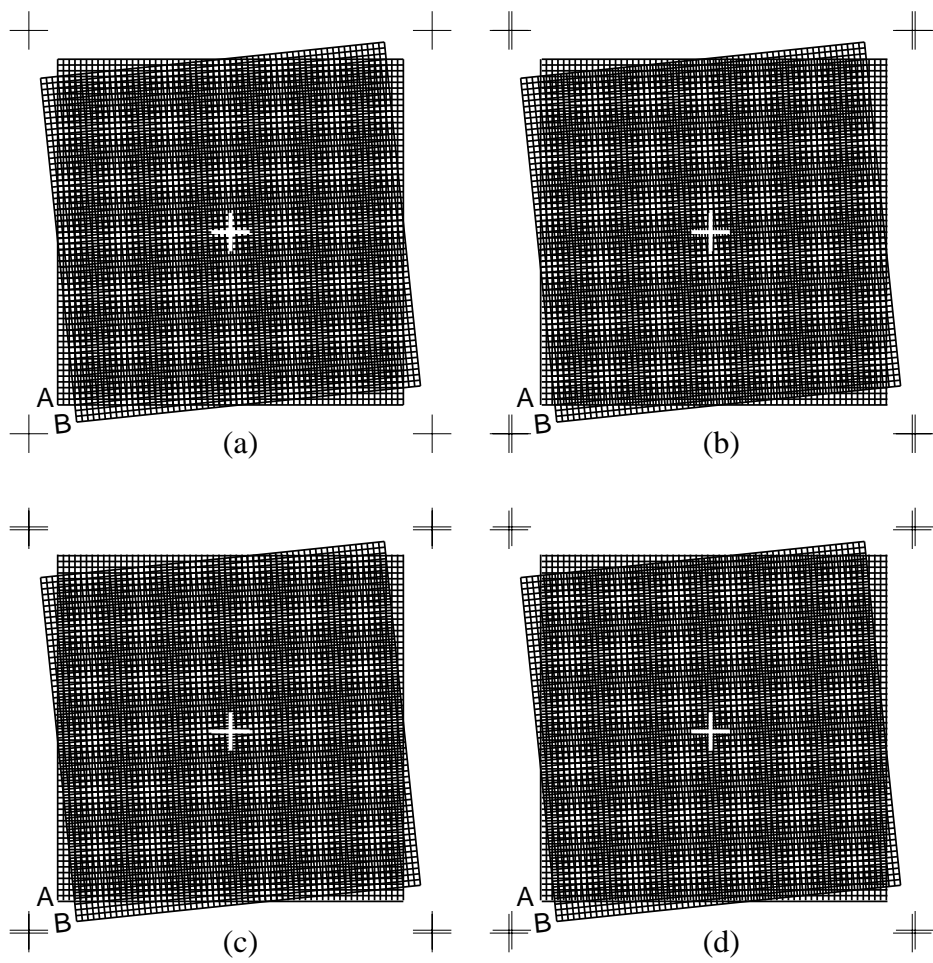
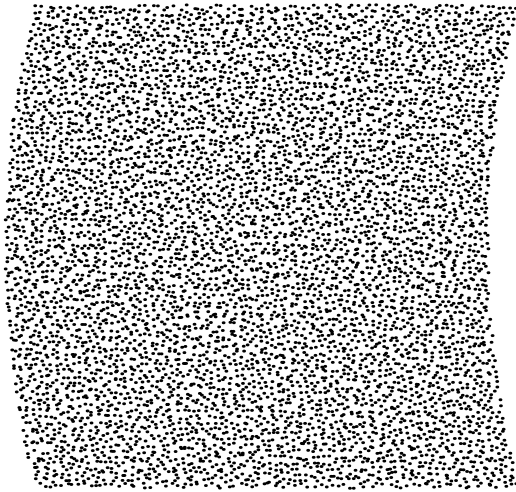
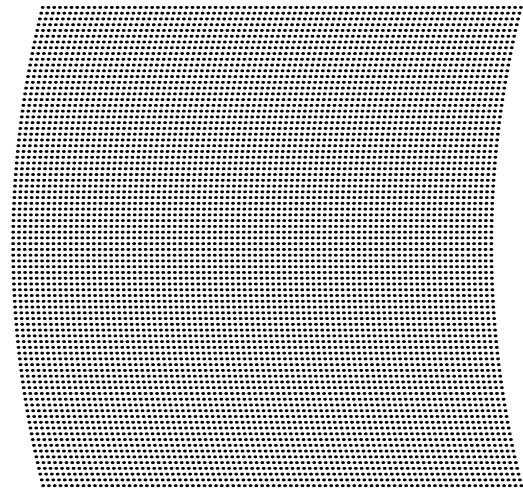

Figure 3.3(a)-(d) from the book: *The Theory of the Moiré Phenomenon Vol. II: Aperiodic Layers*, by I. Amidror, published by Springer, 2007.



(a)



(b)

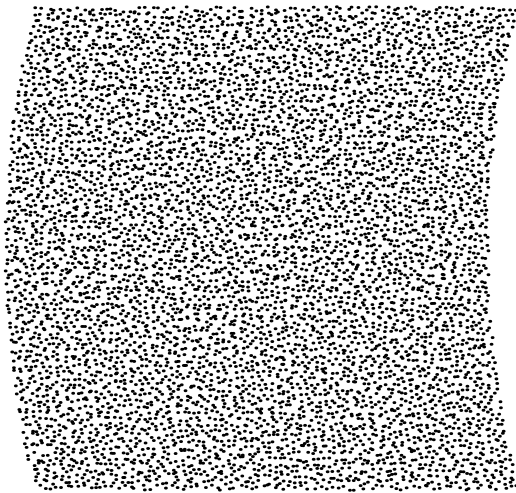

(c)

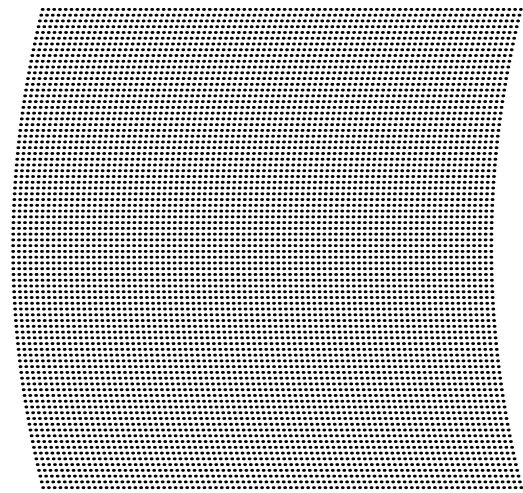

(d)

Figure 3.5(a)-(d) from the book: *The Theory of the Moiré Phenomenon Vol. II: Aperiodic Layers*, by I. Amidror, published by Springer, 2007.

(First layer only.)

(a)

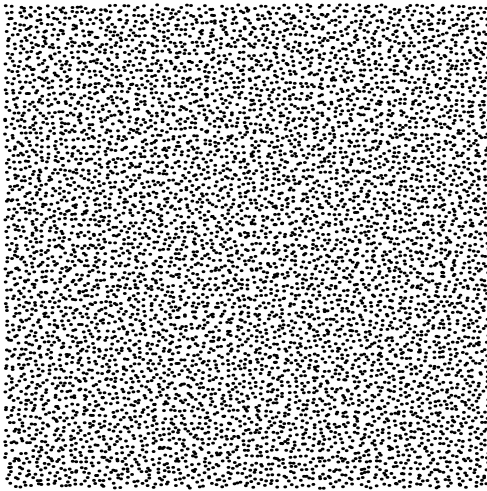

(b)

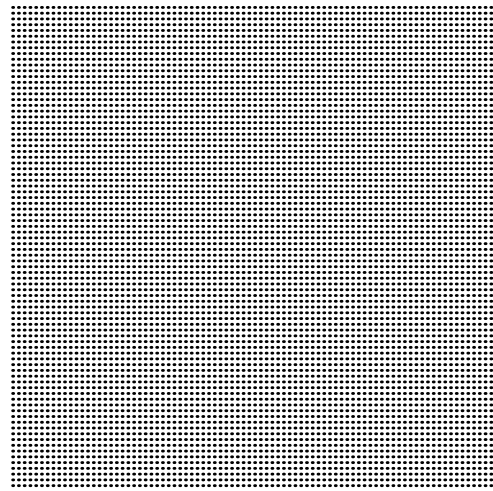

(c)

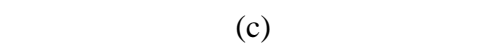

(d)

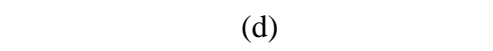
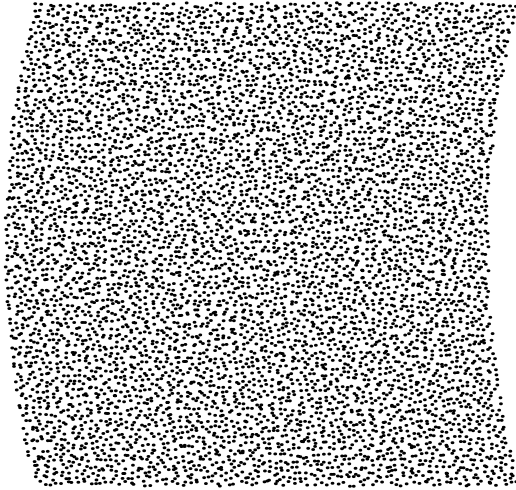
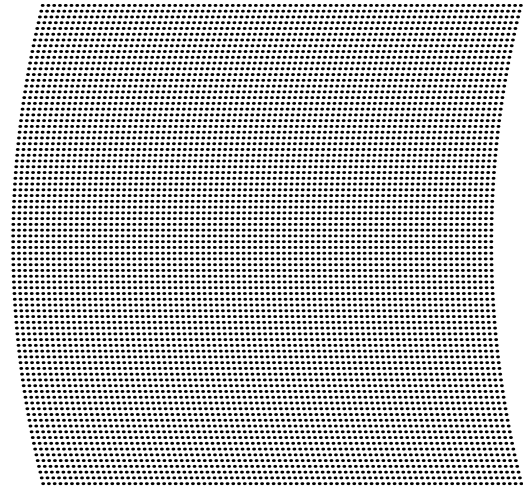

Figure 3.5(a)-(d) from the book: *The Theory of the Moiré Phenomenon Vol. II: Aperiodic Layers*, by I. Amidror, published by Springer, 2007.

(Second layer only.)



(a)



(b)

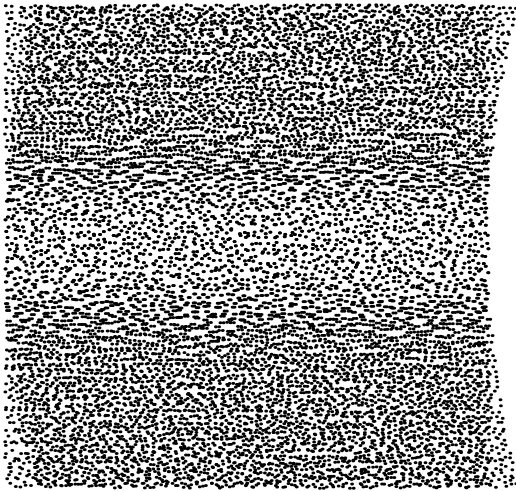

(c)

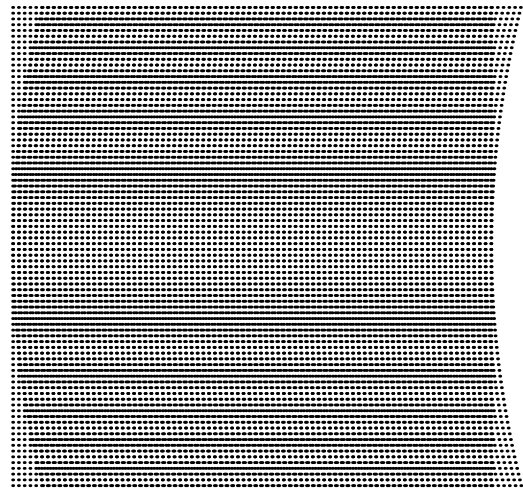

(d)

Figure 3.5(a)-(d) from the book: *The Theory of the Moiré Phenomenon Vol. II: Aperiodic Layers*, by I. Amidror, published by Springer, 2007.

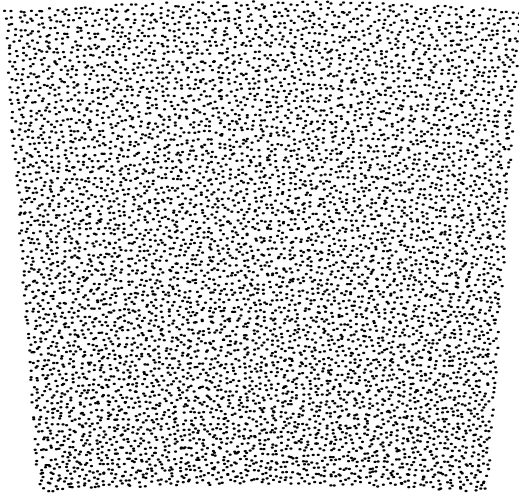

(a)

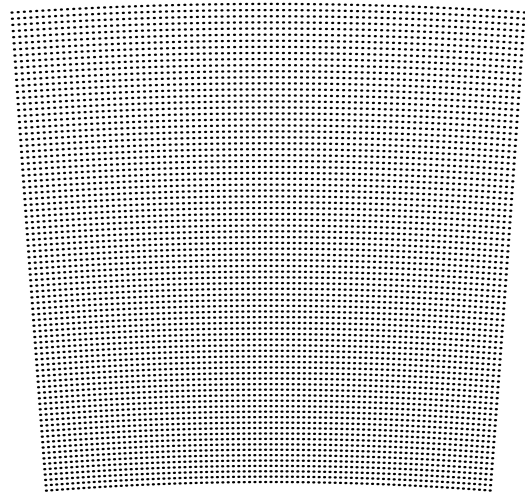

(b)

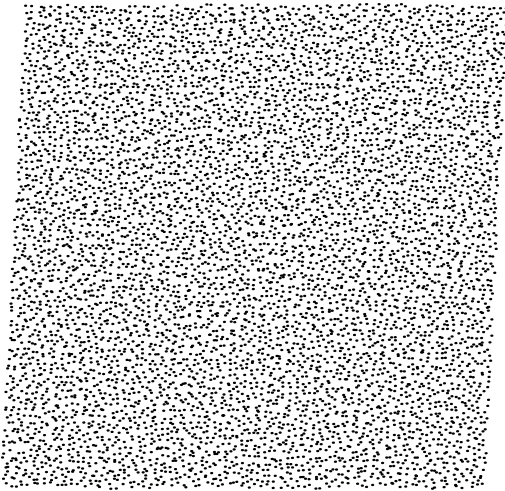

(c)

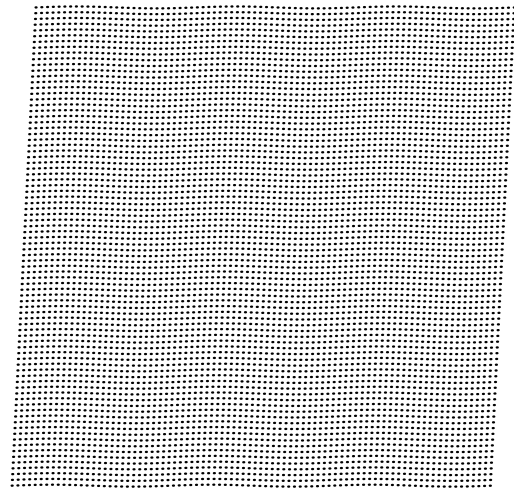

(d)

Figure 4.13(a)-(d) from the book: *The Theory of the Moiré Phenomenon*
Vol. II: Aperiodic Layers, by I. Amidror, published by Springer, 2007.

(First layer only.)

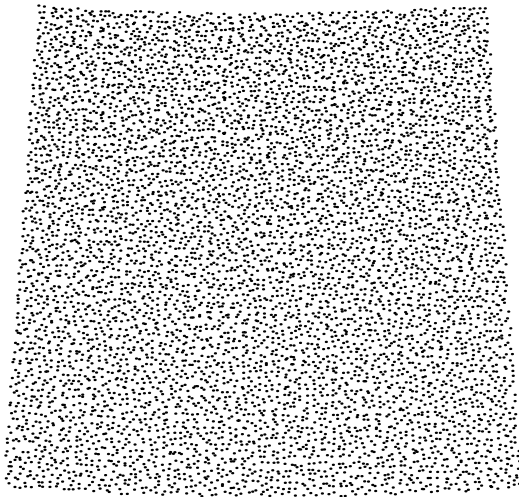

(a)

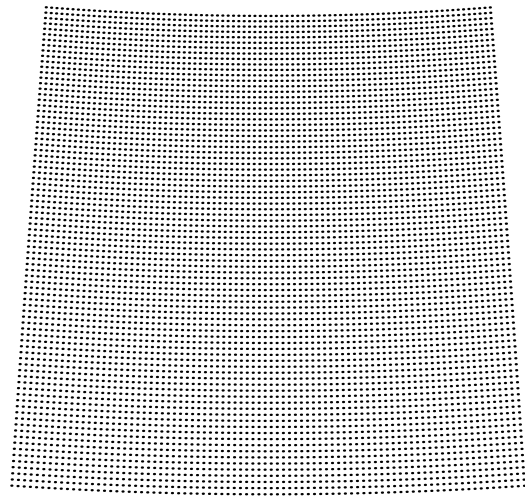

(b)

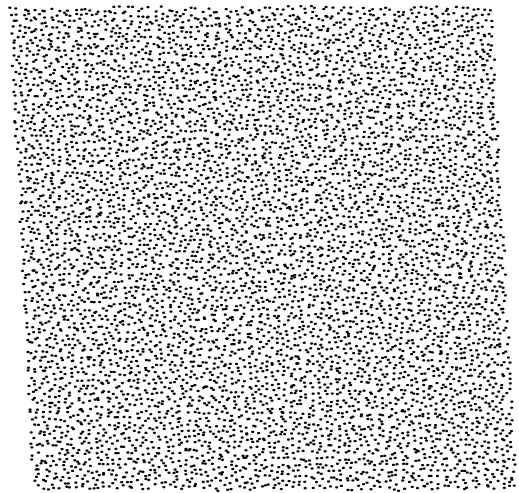

(c)

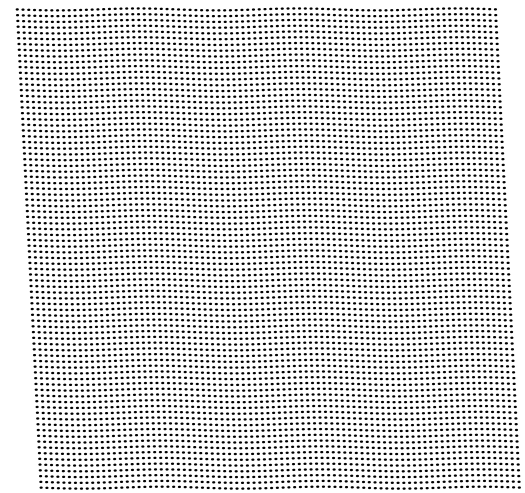

(d)

Figure 4.13(a)-(d) from the book: *The Theory of the Moiré Phenomenon Vol. II: Aperiodic Layers*, by I. Amidror, published by Springer, 2007.

(Second layer only.)

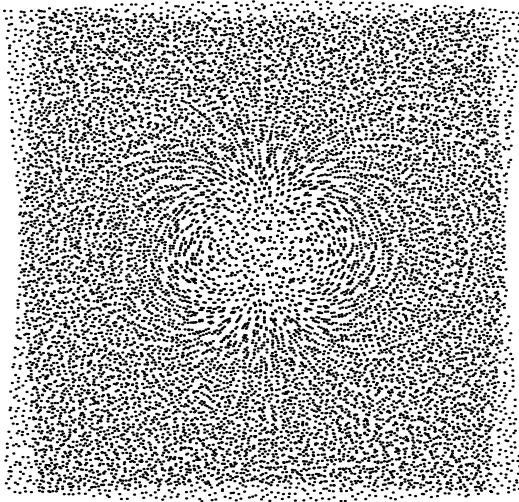

(a)

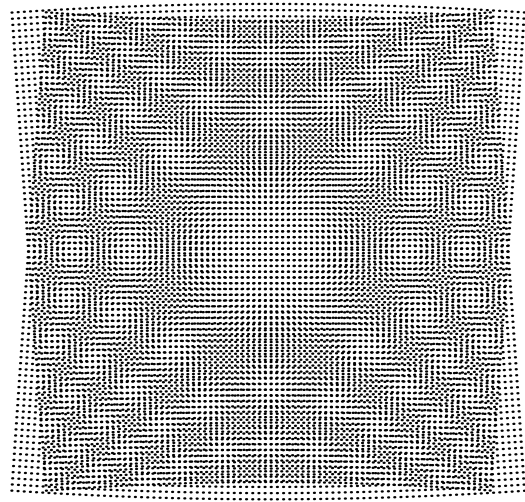

(b)

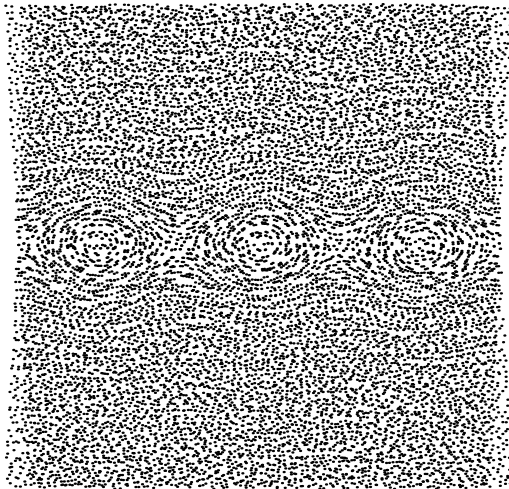

(c)

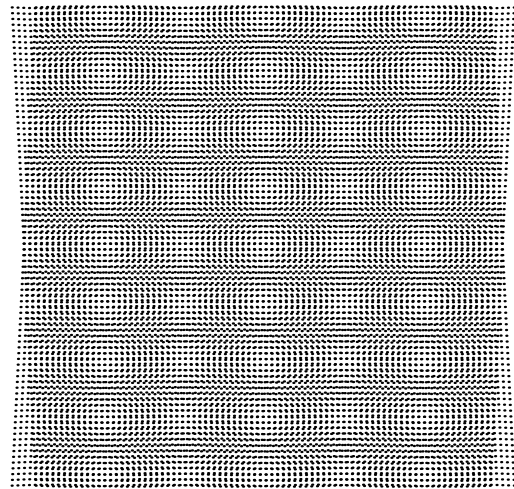

(d)

Figure 4.13(a)-(d) from the book: *The Theory of the Moiré Phenomenon Vol. II: Aperiodic Layers*, by I. Amidror, published by Springer, 2007.

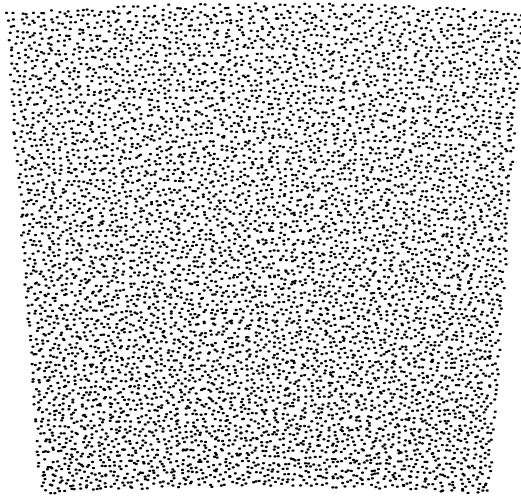

(a)

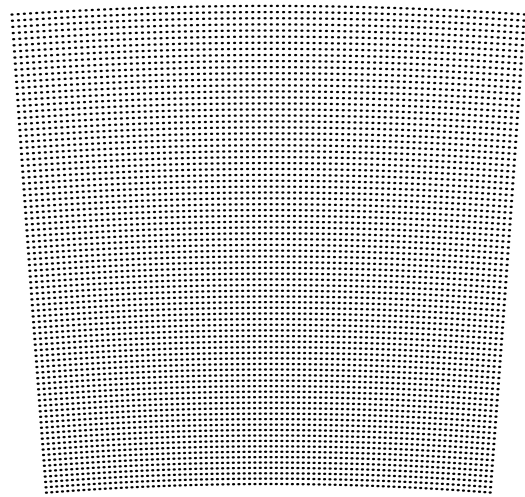

(b)

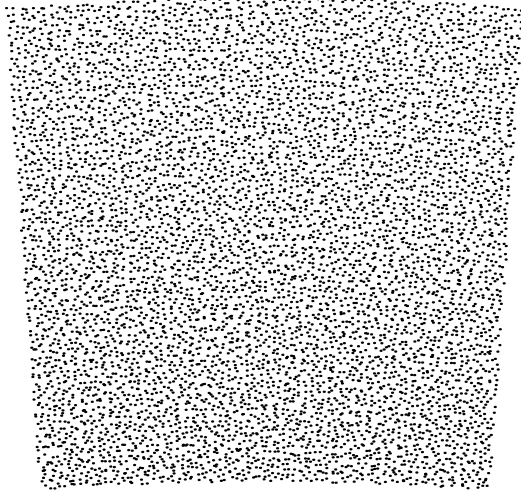

(c)

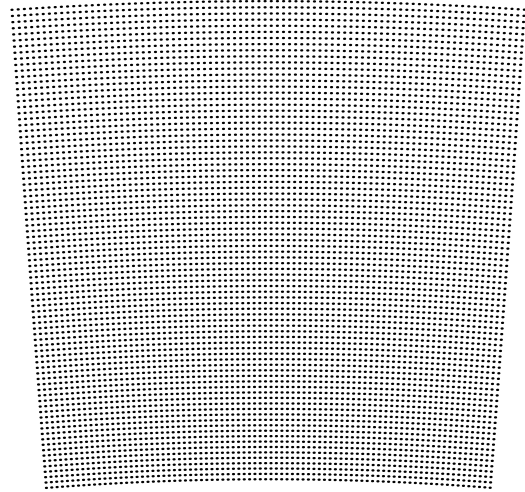

(d)

Figure 5.1(a)-(d) from the book: *The Theory of the Moiré Phenomenon Vol. II: Aperiodic Layers*, by I. Amidror, published by Springer, 2007.

(First layer only.)

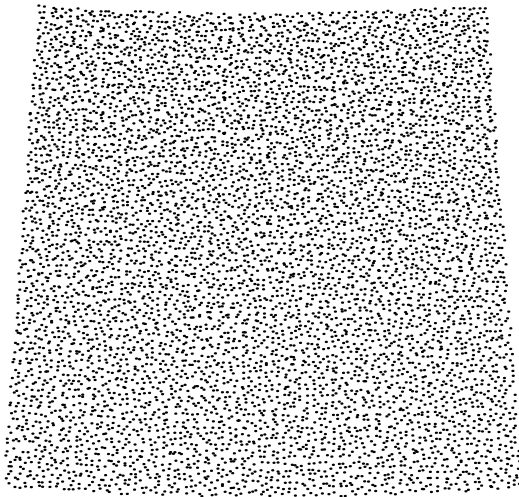

(a)

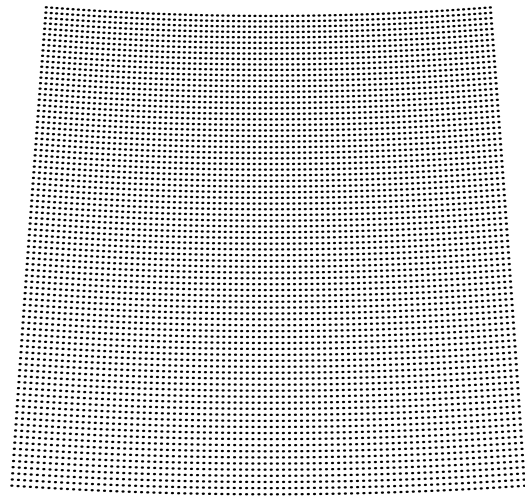

(b)

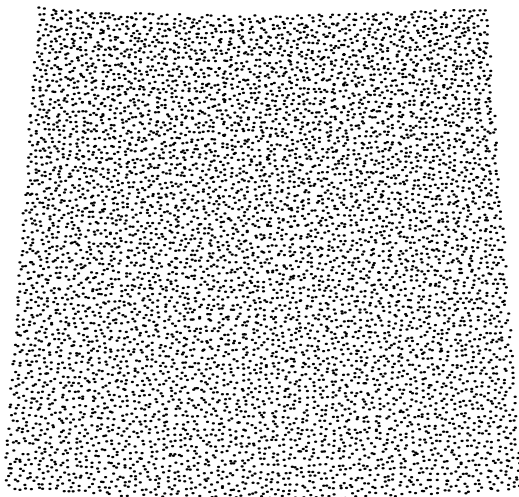

(c)

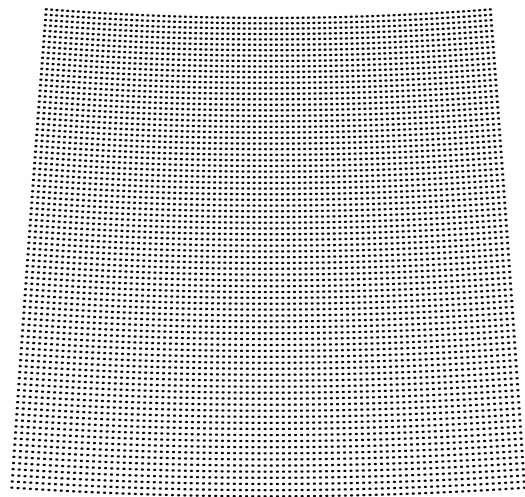

(d)

Figure 5.1(a)-(d) from the book: *The Theory of the Moiré Phenomenon Vol. II: Aperiodic Layers*, by I. Amidror, published by Springer, 2007.

(Second layer only.)

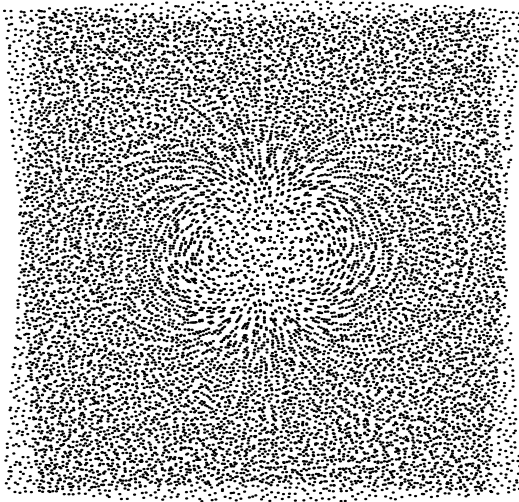

(a)

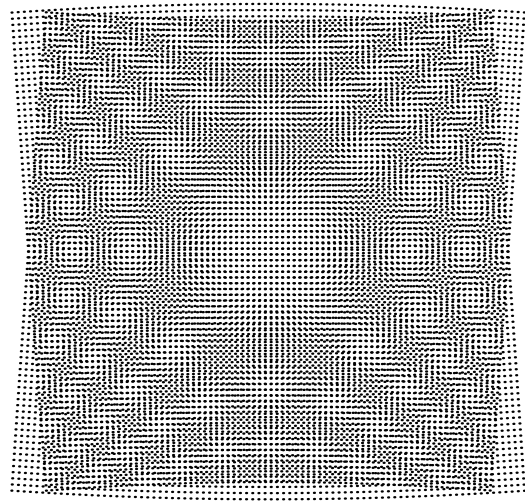

(b)

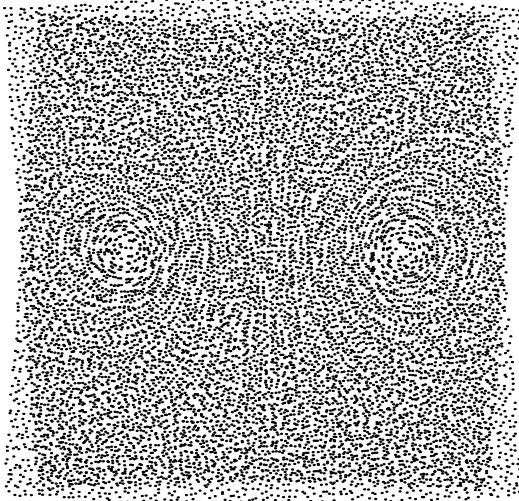

(c)

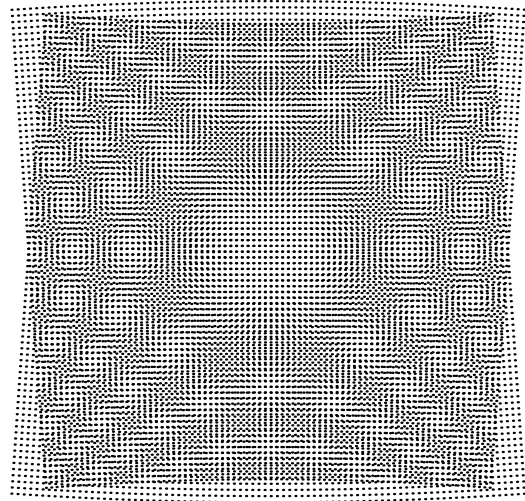

(d)

Figure 5.1(a)-(d) from the book: *The Theory of the Moiré Phenomenon Vol. II: Aperiodic Layers*, by I. Amidror, published by Springer, 2007.

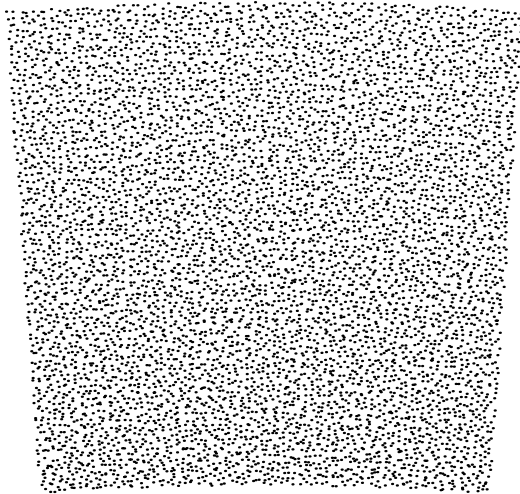

(e)

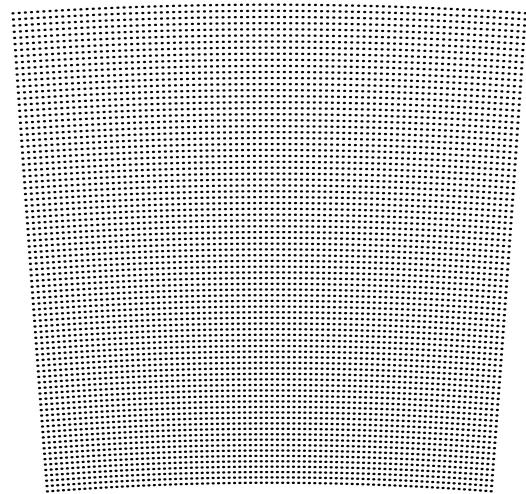

(f)

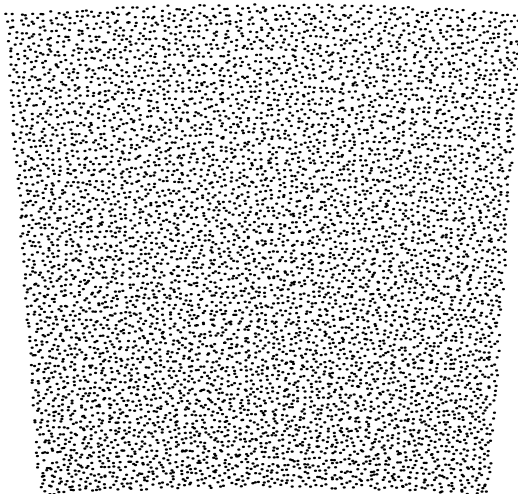

(g)

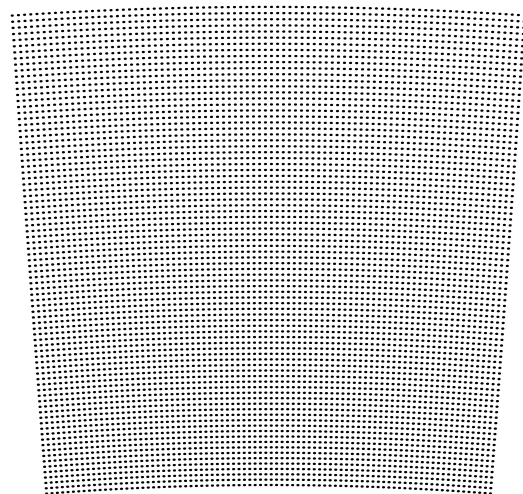

(h)

Figure 5.1(e)-(h) from the book: *The Theory of the Moiré Phenomenon Vol. II: Aperiodic Layers*, by I. Amidror, published by Springer, 2007.

(First layer only.)

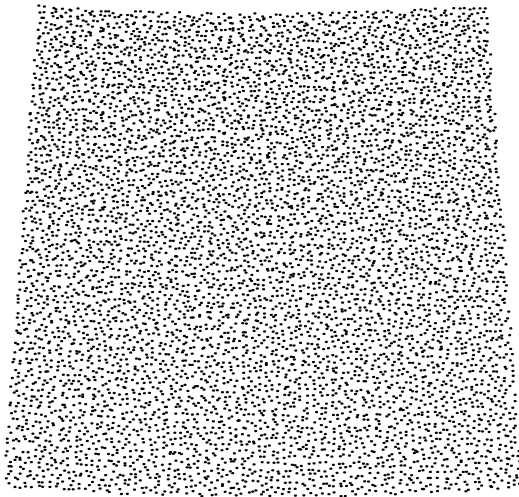

(e)

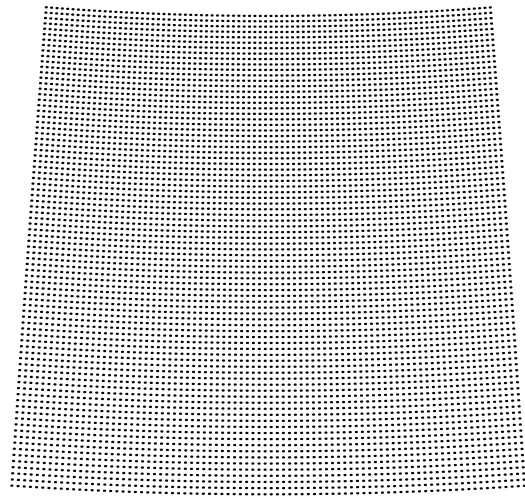

(f)

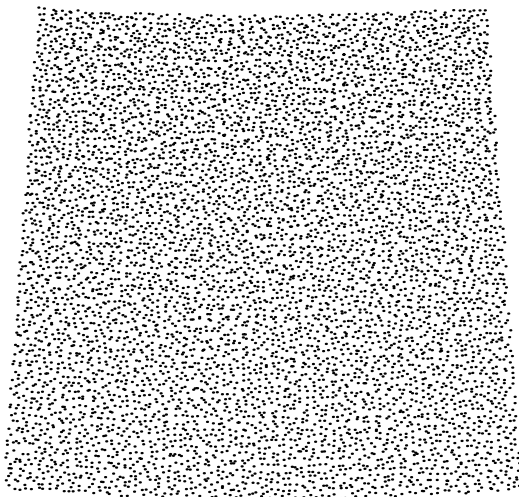

(g)

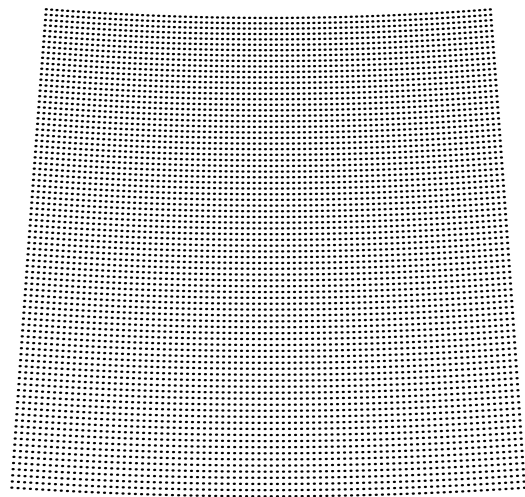

(h)

Figure 5.1(e)-(h) from the book: *The Theory of the Moiré Phenomenon Vol. II: Aperiodic Layers*, by I. Amidror, published by Springer, 2007.

(Second layer only.)

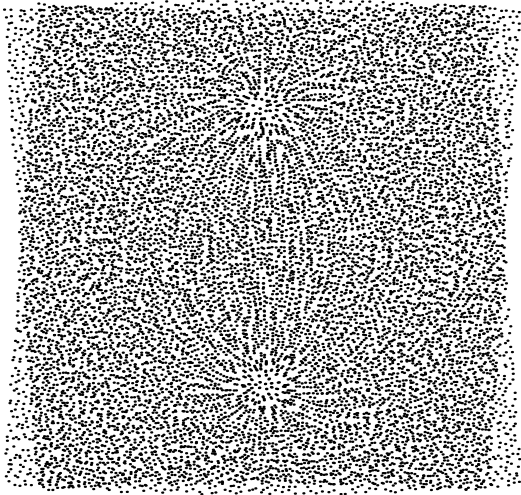

(e)

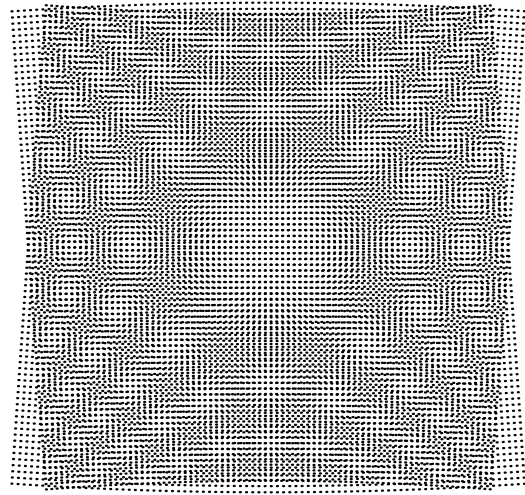

(f)

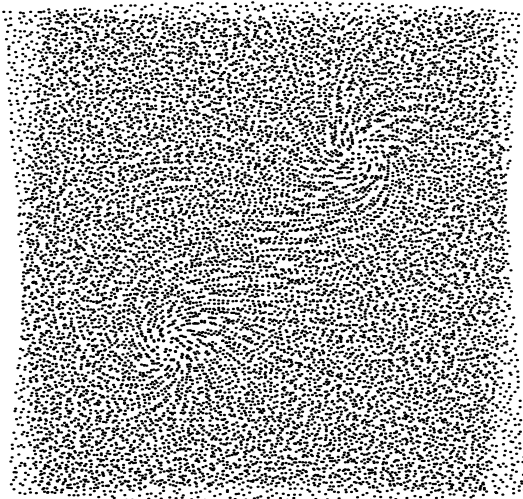

(g)

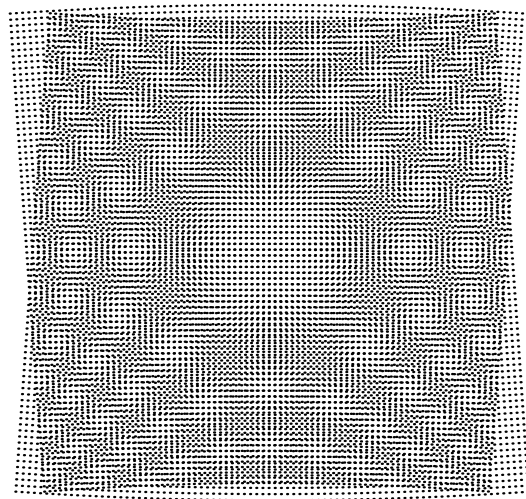

(h)

Figure 5.1(e)-(h) from the book: *The Theory of the Moiré Phenomenon Vol. II: Aperiodic Layers*, by I. Amidror, published by Springer, 2007.

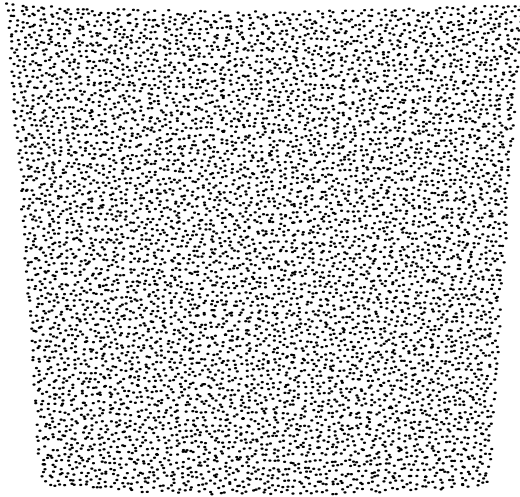

(a)

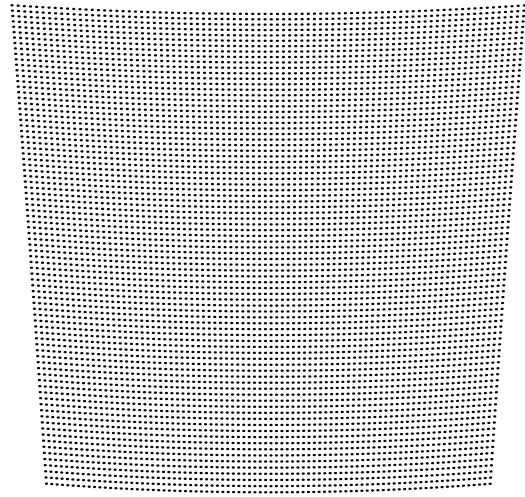

(b)

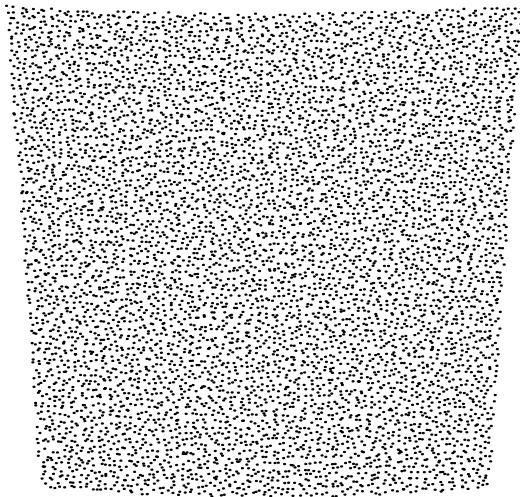

(c)

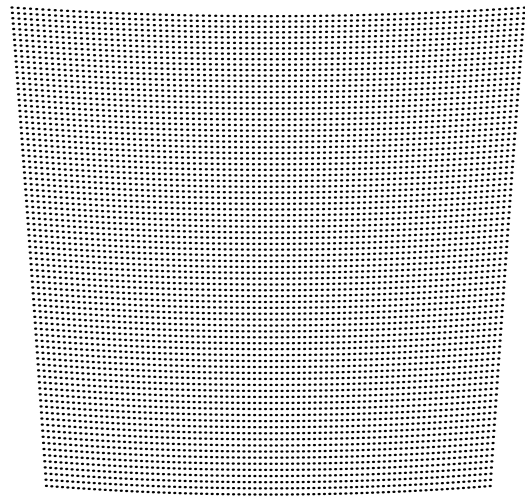

(d)

Figure 5.9(a)-(d) from the book: *The Theory of the Moiré Phenomenon Vol. II: Aperiodic Layers*, by I. Amidror, published by Springer, 2007.

(First layer only.)

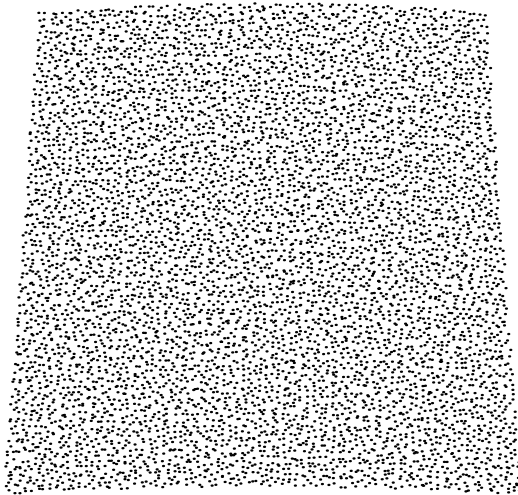

(a)

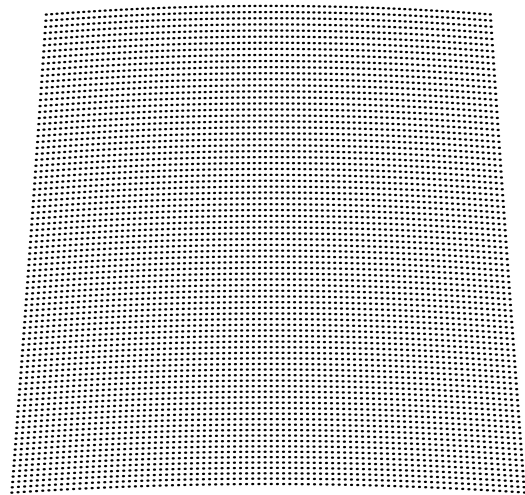

(b)

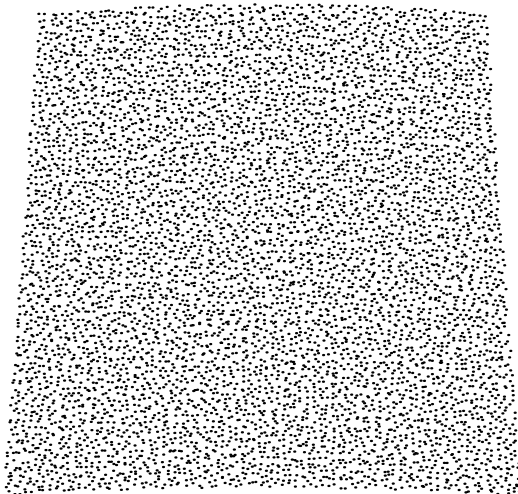

(c)

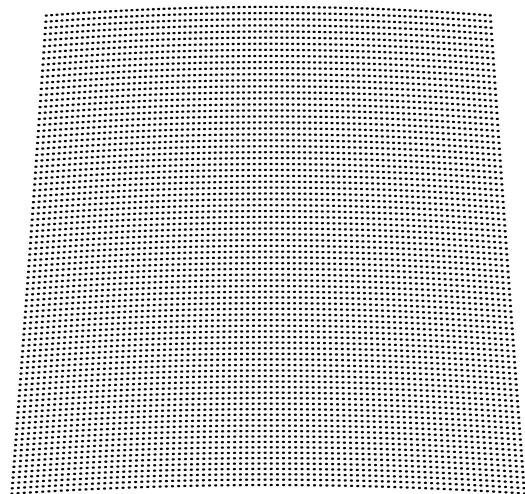

(d)

Figure 5.9(a)-(d) from the book: *The Theory of the Moiré Phenomenon Vol. II: Aperiodic Layers*, by I. Amidror, published by Springer, 2007.

(Second layer only.)

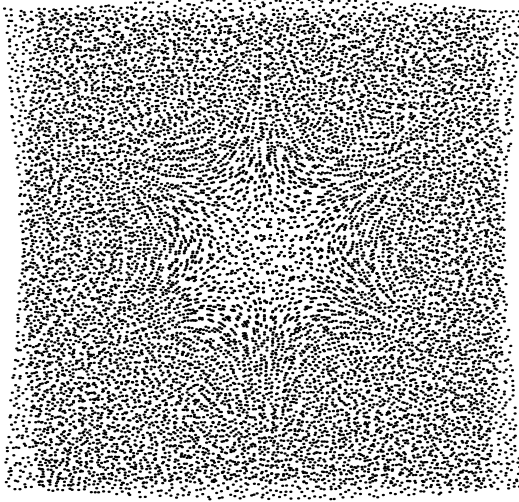

(a)

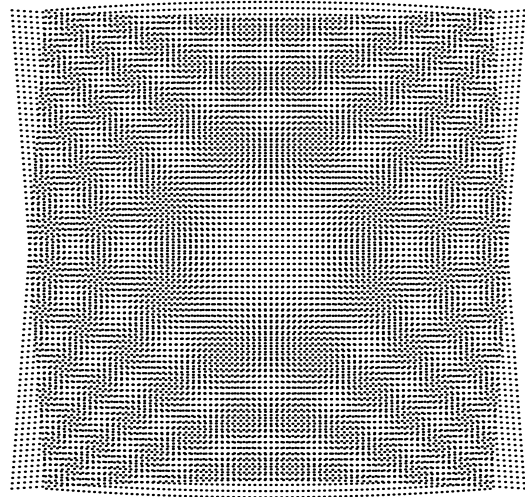

(b)

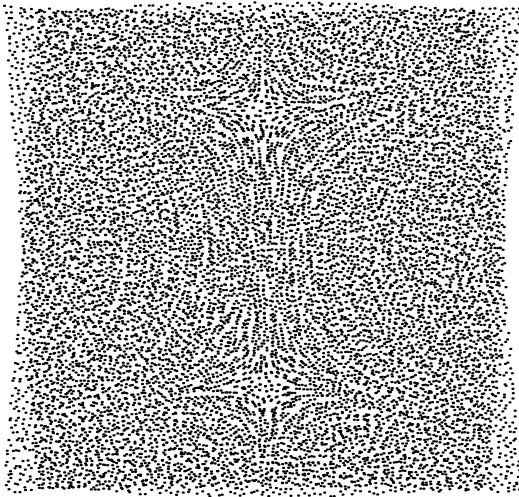

(c)

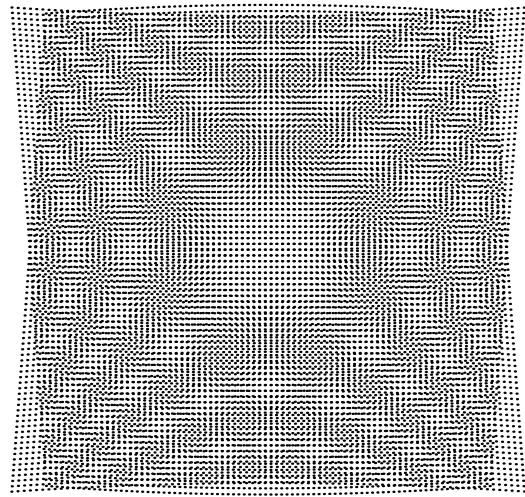

(d)

Figure 5.9(a)-(d) from the book: *The Theory of the Moiré Phenomenon Vol. II: Aperiodic Layers*, by I. Amidror, published by Springer, 2007.

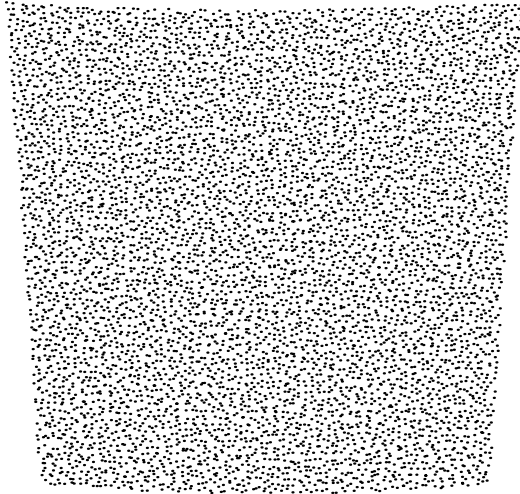

(a)

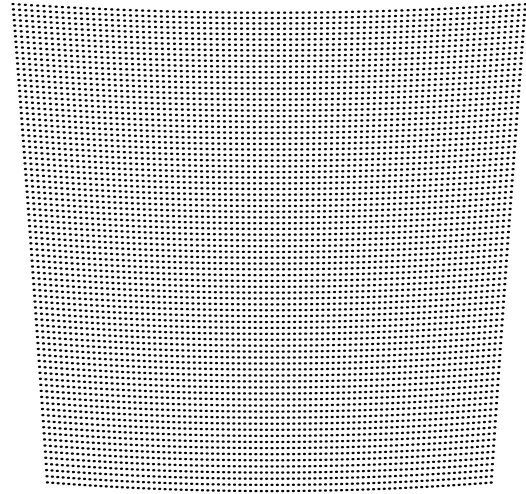

(b)

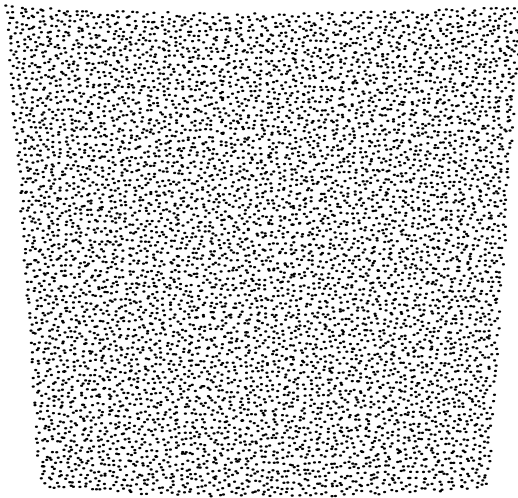

(c)

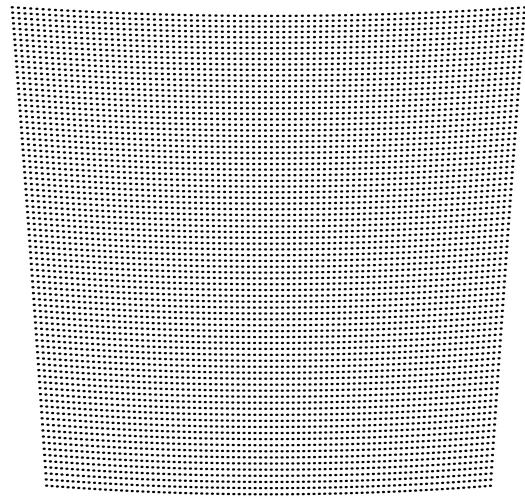

(d)

Figure 5.9(e)-(h) from the book: *The Theory of the Moiré Phenomenon Vol. II: Aperiodic Layers*, by I. Amidror, published by Springer, 2007.

(First layer only.)

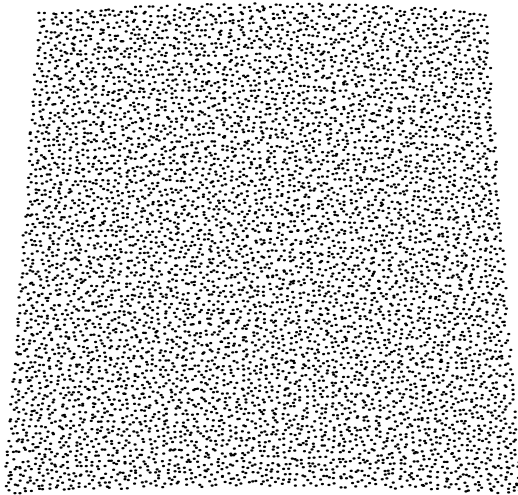

(a)

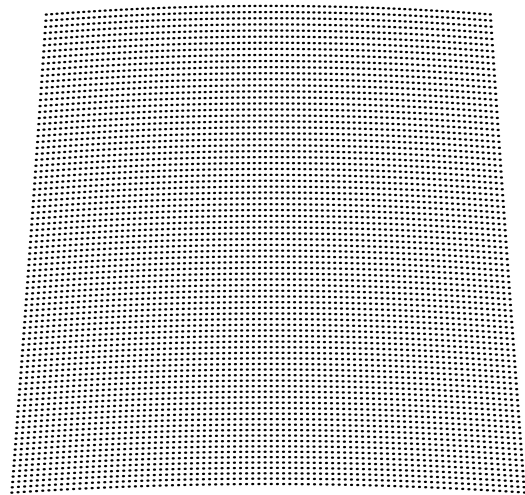

(b)

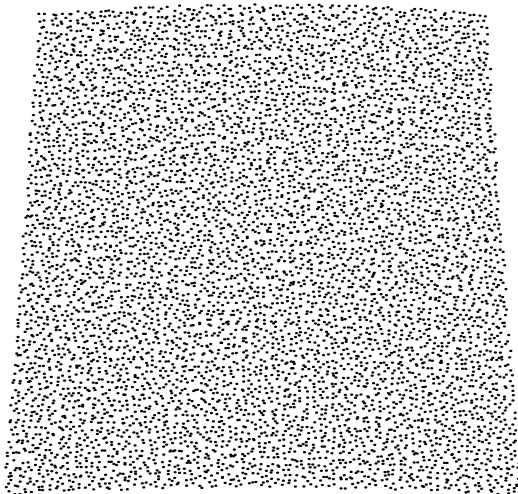

(c)

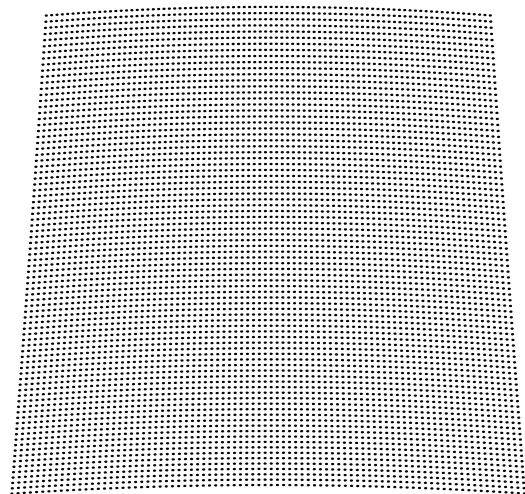

(d)

Figure 5.9(e)-(h) from the book: *The Theory of the Moiré Phenomenon Vol. II: Aperiodic Layers*, by I. Amidror, published by Springer, 2007.

(Second layer only.)

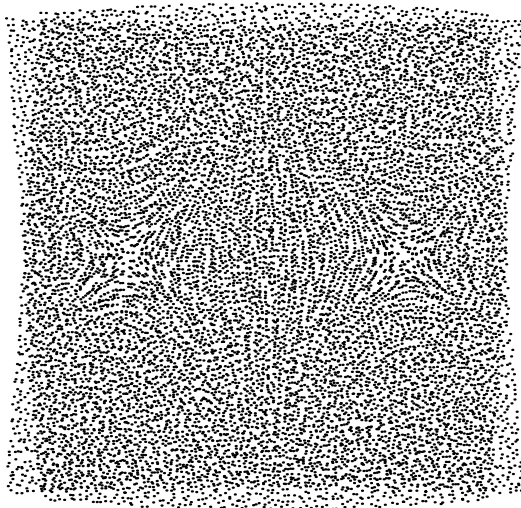

(a)

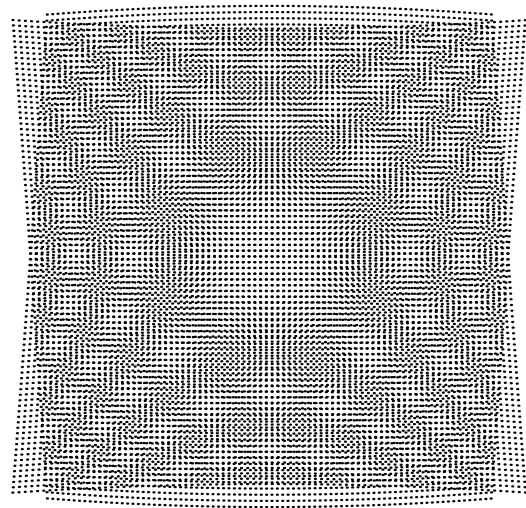

(b)

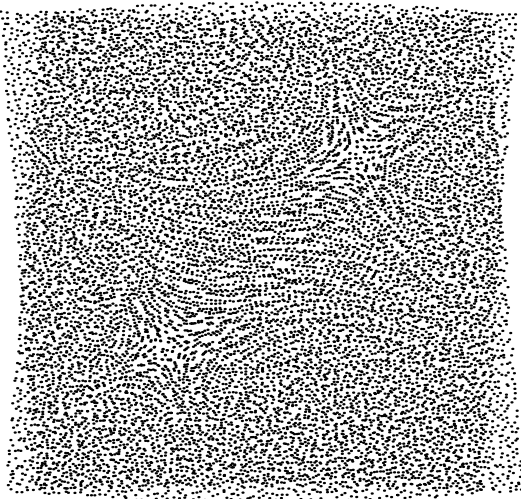

(c)

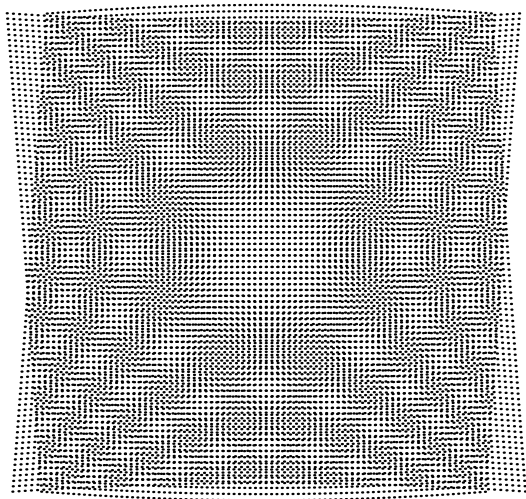

(d)

Figure 5.9(e)-(h) from the book: *The Theory of the Moiré Phenomenon Vol. II: Aperiodic Layers*, by I. Amidror, published by Springer, 2007.

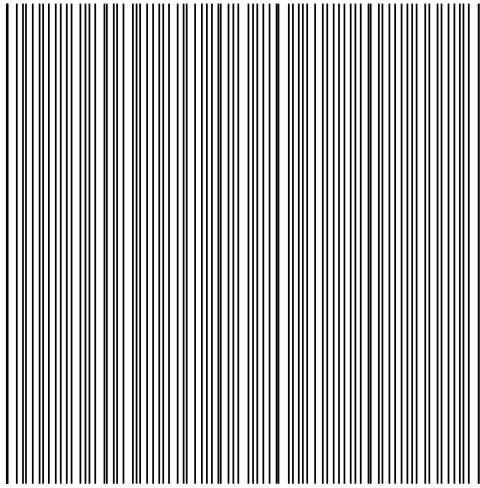

(a)

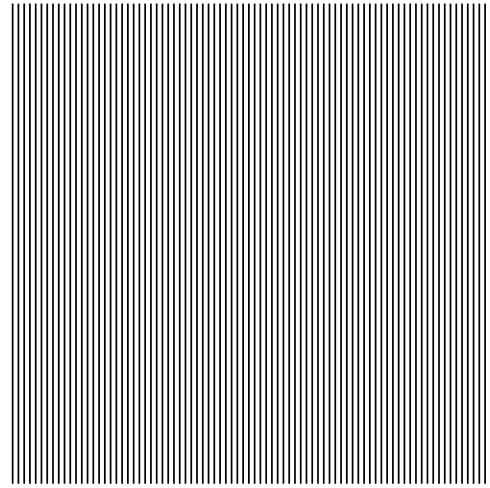

(b)

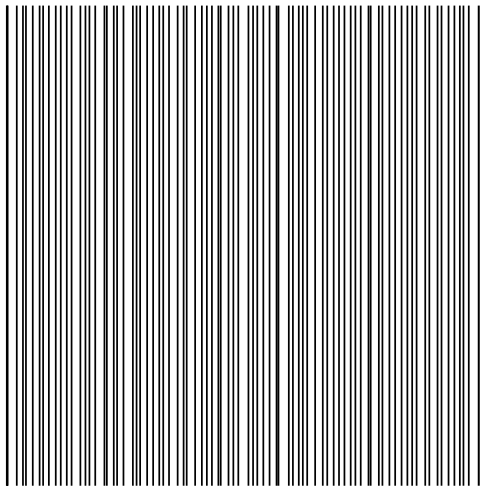

(c)

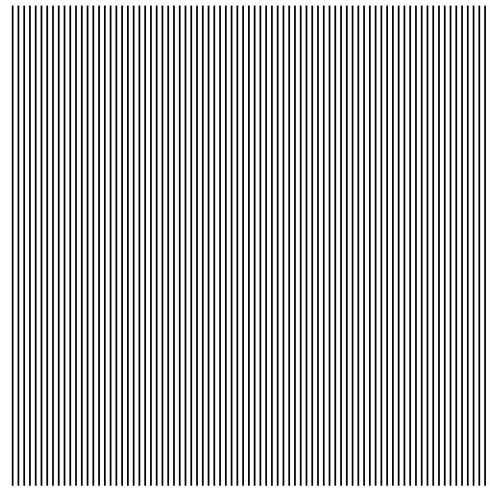

(d)

Figure 6.1(a)-(d) from the book: *The Theory of the Moiré Phenomenon Vol. II: Aperiodic Layers*, by I. Amidror, published by Springer, 2007.

(First layer only.)

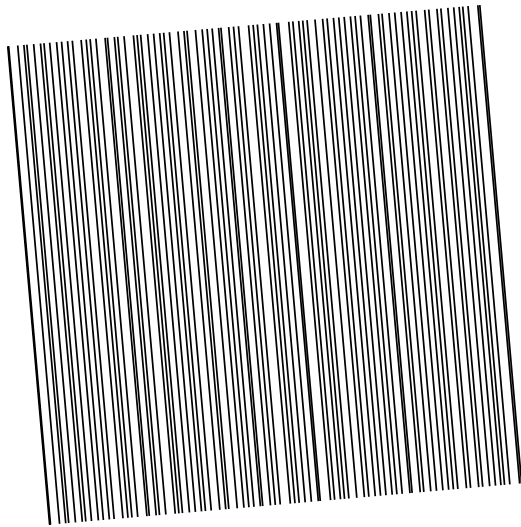

(a)

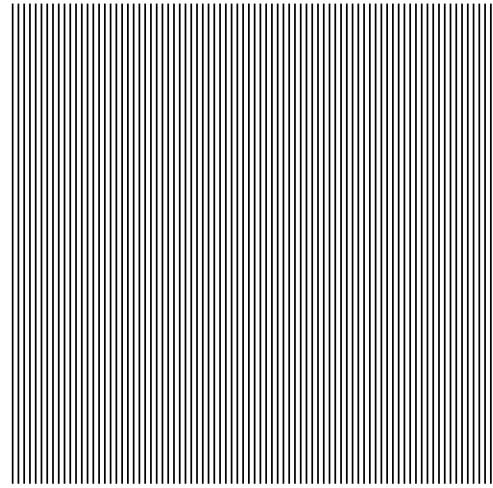

(b)

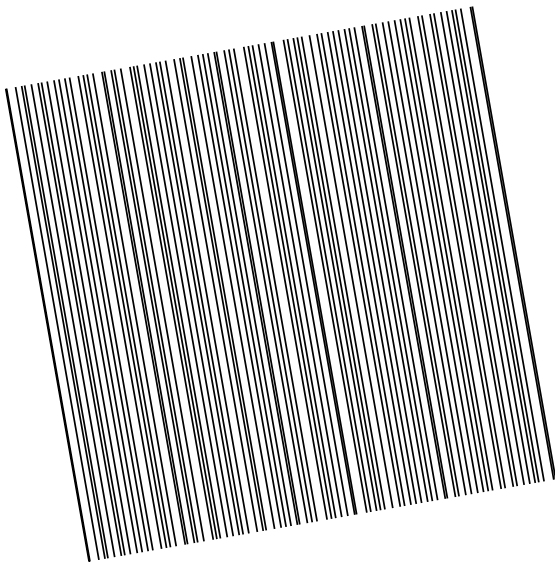

(c)

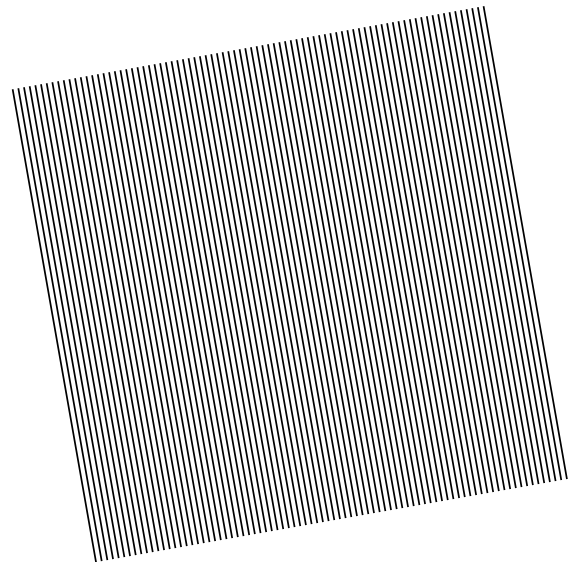

(d)

Figure 6.1(a)-(d) from the book: *The Theory of the Moiré Phenomenon Vol. II: Aperiodic Layers*, by I. Amidror, published by Springer, 2007.

(Second layer only.)

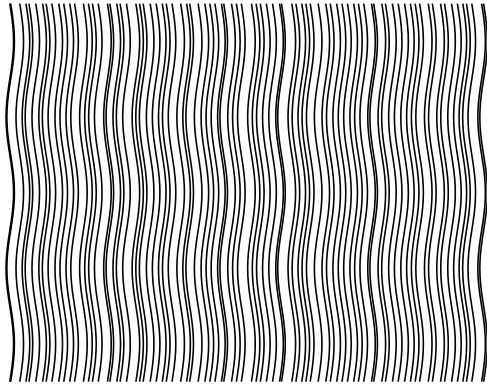

(a)

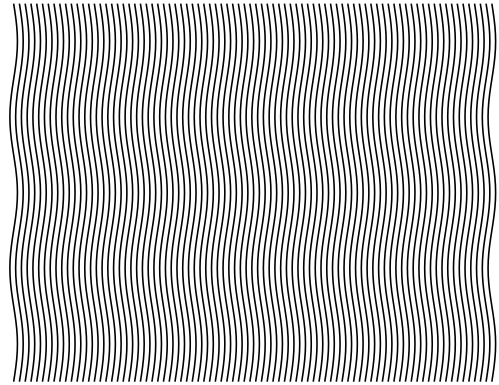

(b)

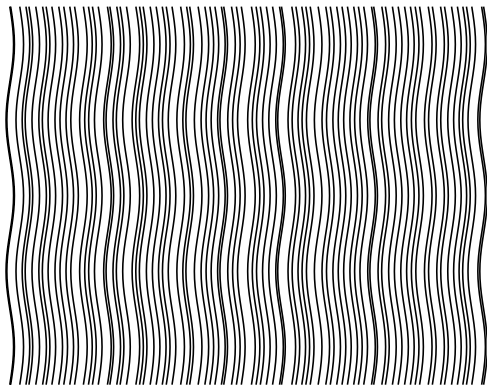

(c)

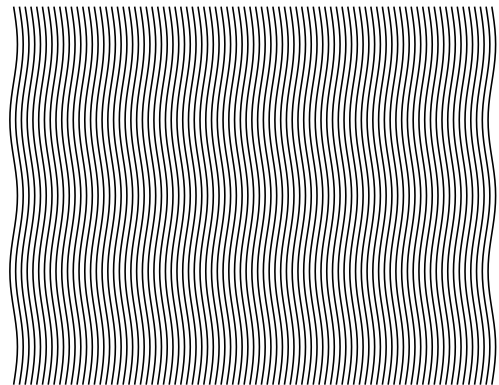

(d)

Figure 6.17(a)-(d) from the book: *The Theory of the Moiré Phenomenon*
Vol. II: Aperiodic Layers, by I. Amidror, published by Springer, 2007.

(First layer only.)

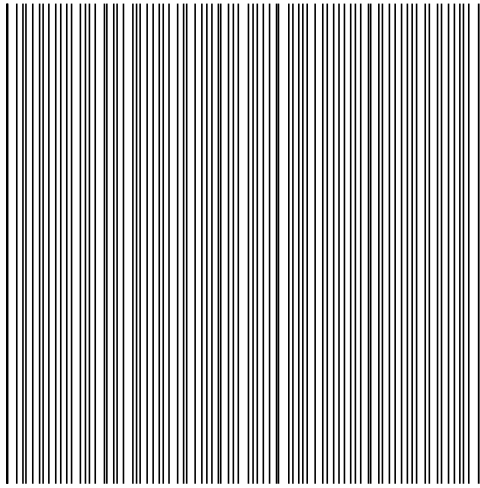

(a)

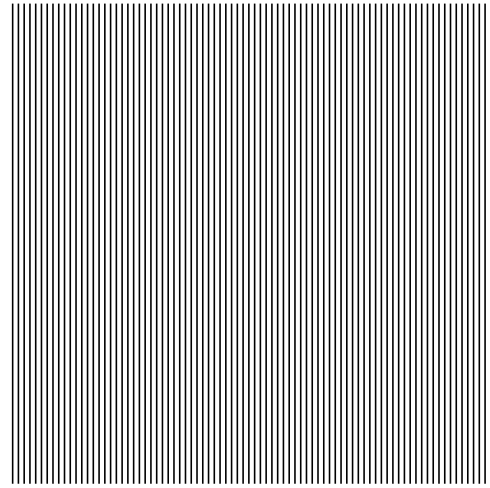

(b)

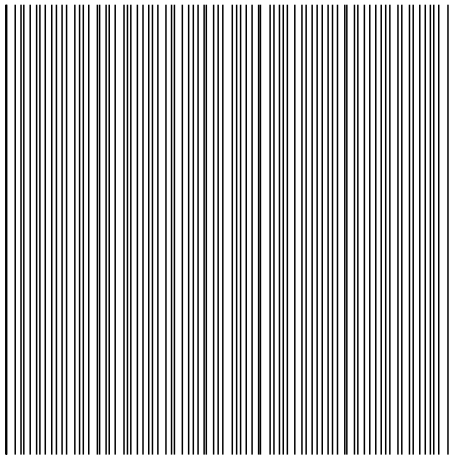

(c)

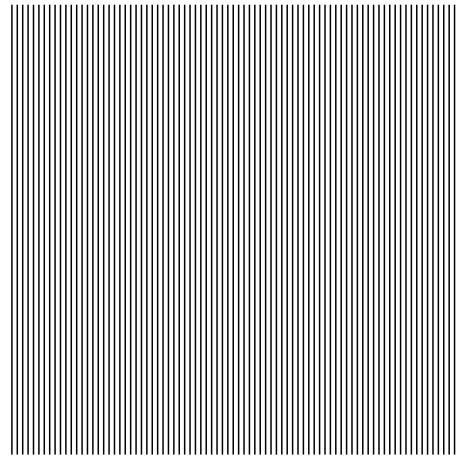

(d)

Figure 6.17(a)-(d) from the book: *The Theory of the Moiré Phenomenon*
Vol. II: Aperiodic Layers, by I. Amidror, published by Springer, 2007.

(Second layer only.)

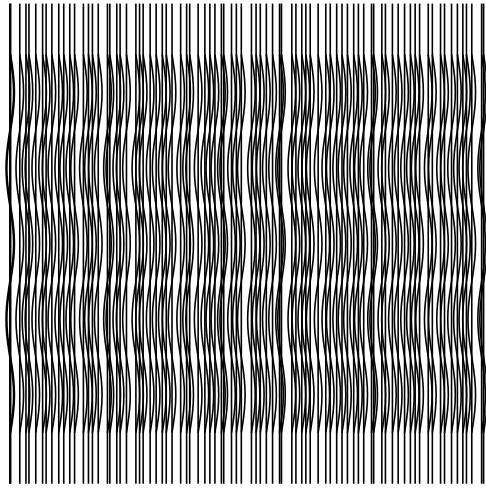

(a)

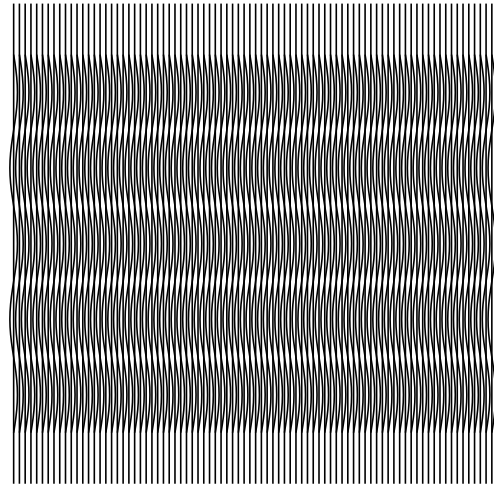

(b)

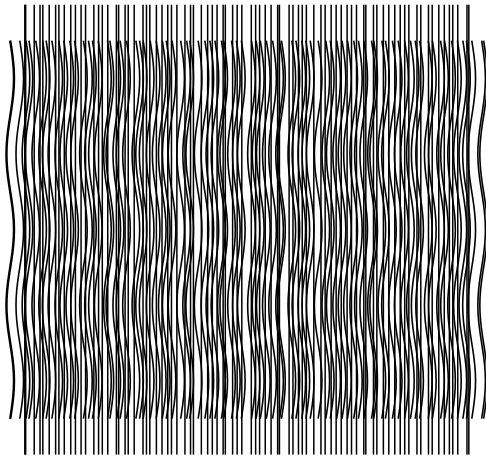

(c)

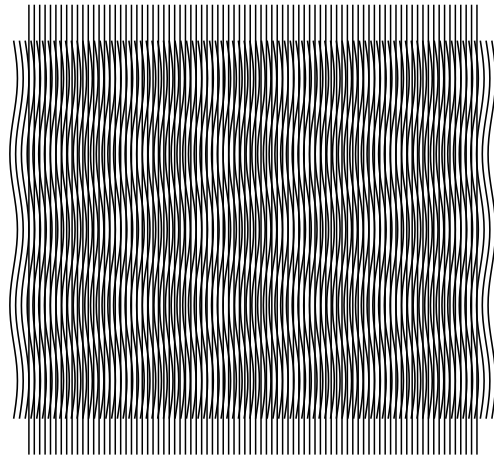

(d)

Figure 6.17(a)-(d) from the book: *The Theory of the Moiré Phenomenon Vol. II: Aperiodic Layers*, by I. Amidror, published by Springer, 2007.

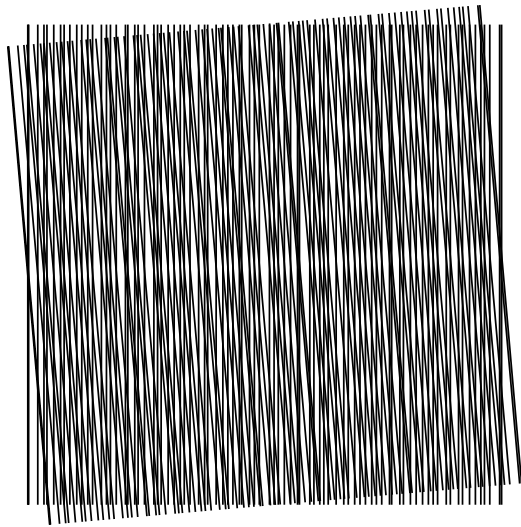

(a)

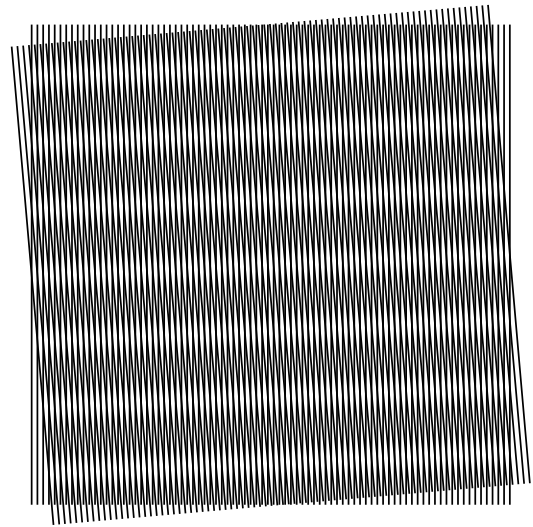

(b)

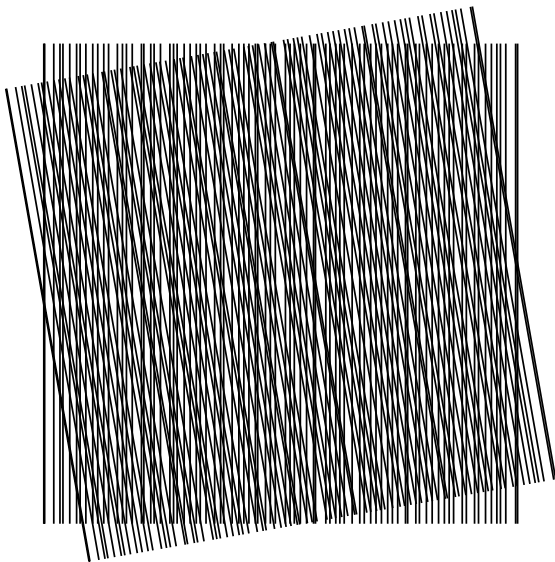

(c)

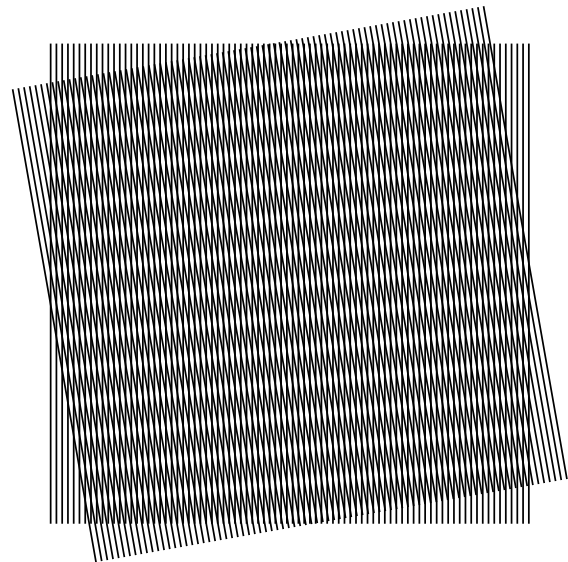

(d)

Figure 6.1(a)-(d) from the book: *The Theory of the Moiré Phenomenon Vol. II: Aperiodic Layers*, by I. Amidror, published by Springer, 2007.

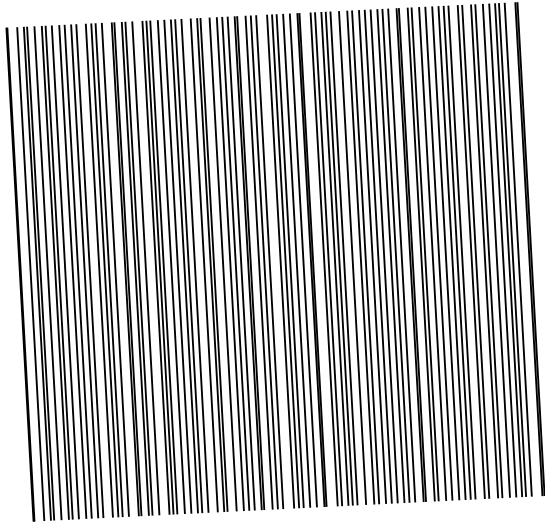

(a)

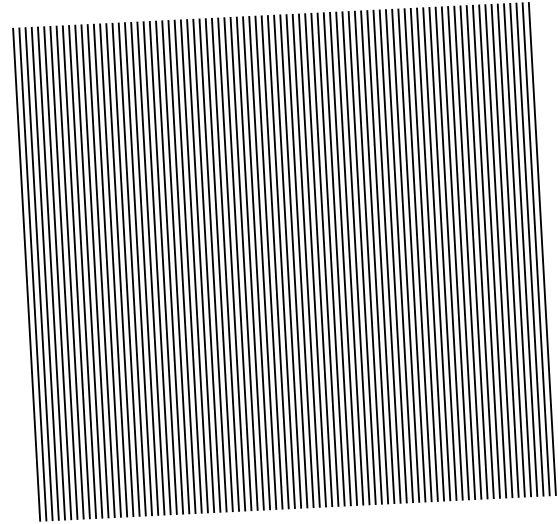

(b)

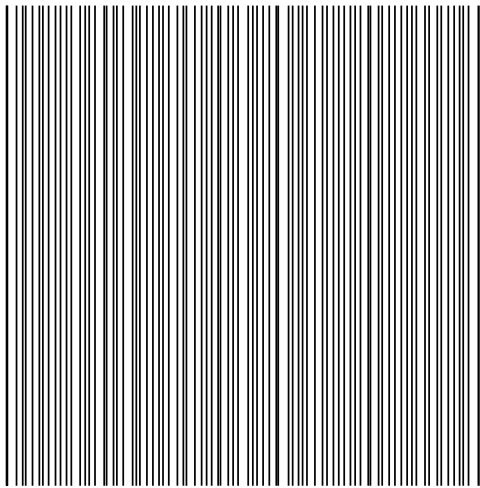

(c)

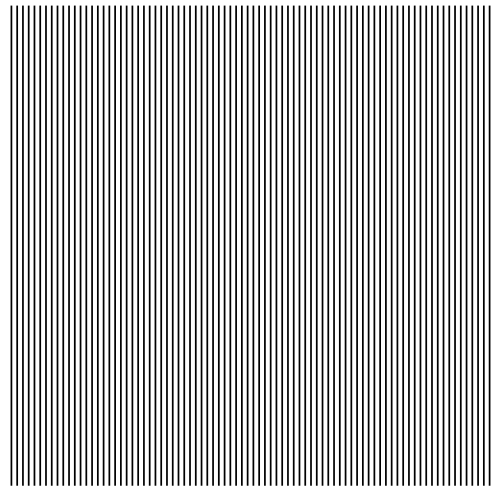

(d)

Figure 6.2(a)-(d) from the book: *The Theory of the Moiré Phenomenon*
Vol. II: Aperiodic Layers, by I. Amidror, published by Springer, 2007.

(First layer only.)

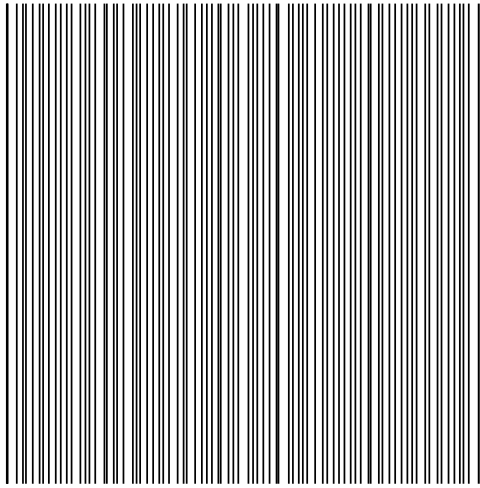

(a)

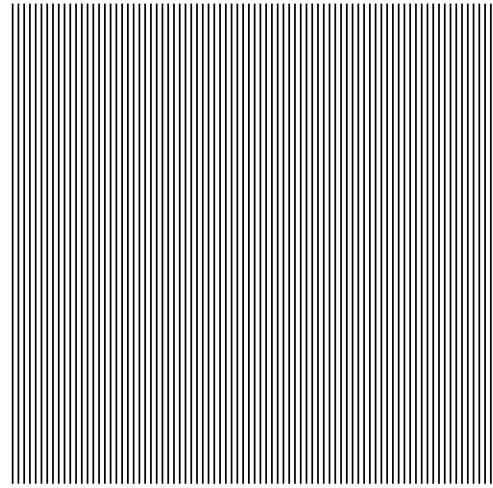

(b)

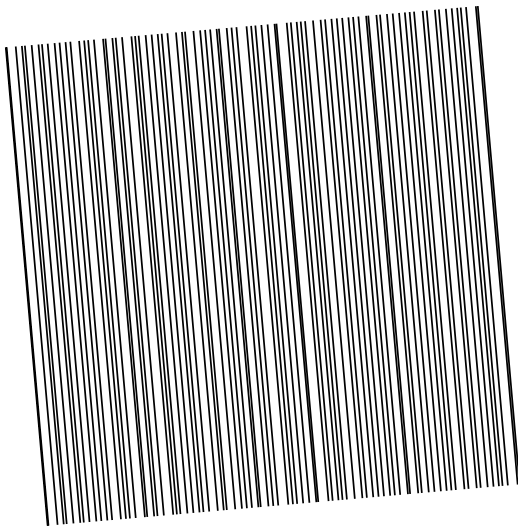

(c)

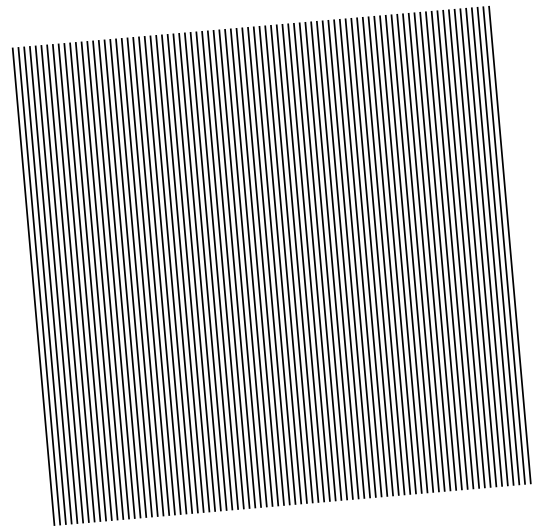

(d)

Figure 6.2(a)-(d) from the book: *The Theory of the Moiré Phenomenon Vol. II: Aperiodic Layers*, by I. Amidror, published by Springer, 2007.

(Second layer only.)

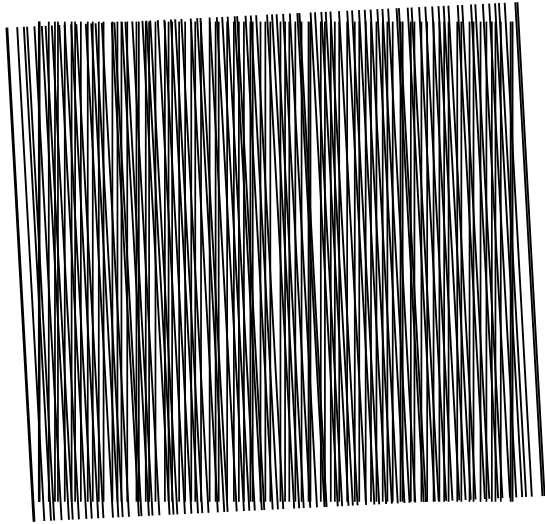

(a)

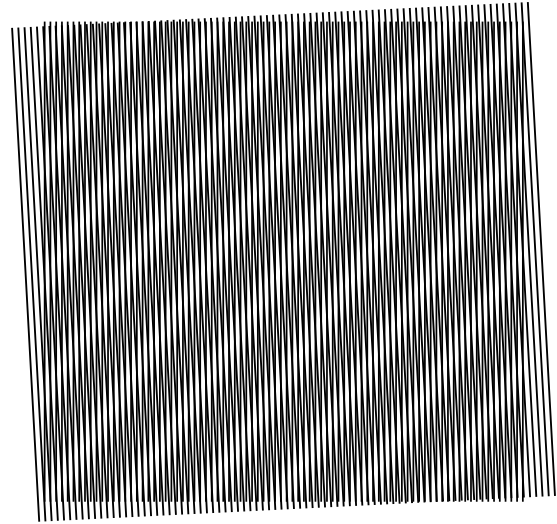

(b)

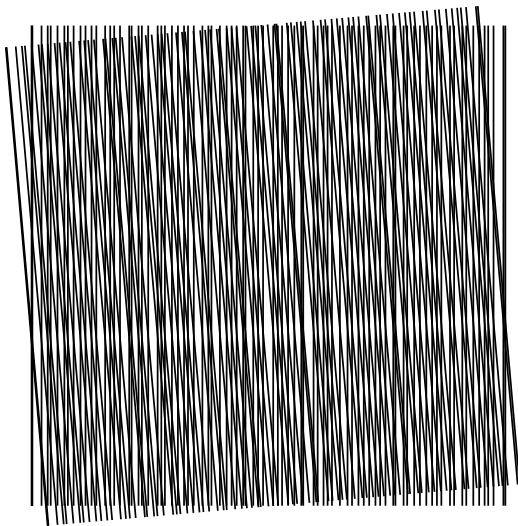

(c)

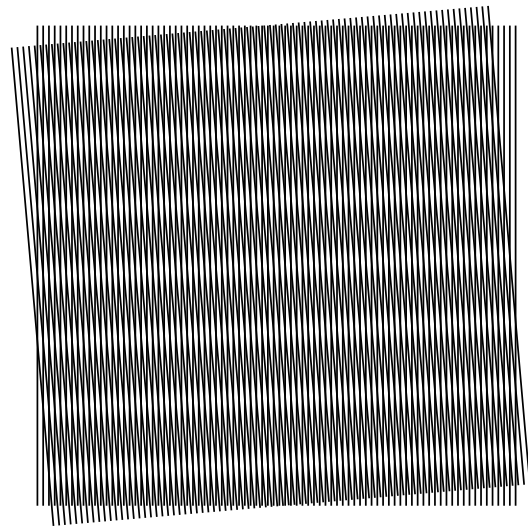

(d)

Figure 6.2(a)-(d) from the book: *The Theory of the Moiré Phenomenon Vol. II: Aperiodic Layers*, by I. Amidror, published by Springer, 2007.

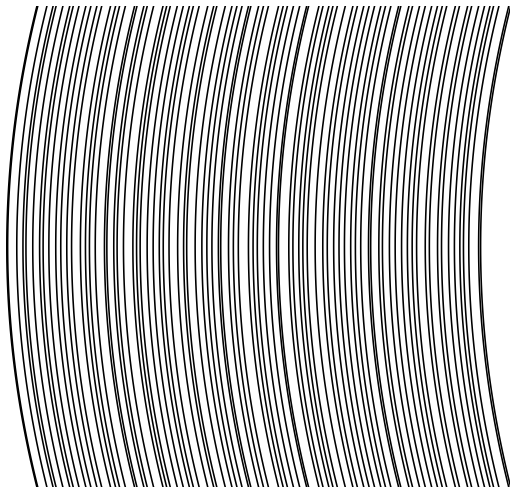

(a)

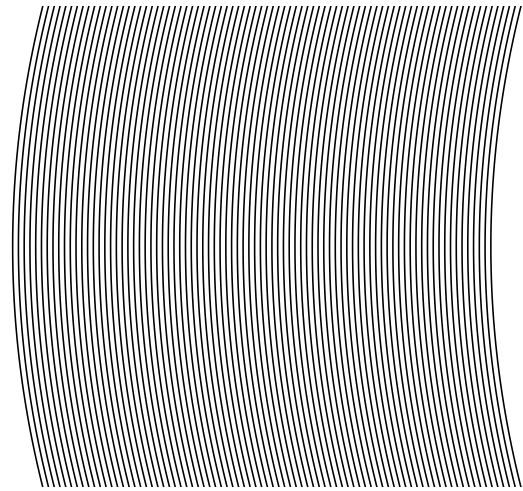

(b)

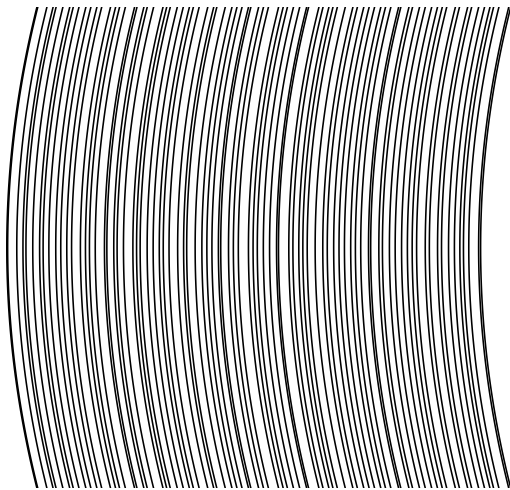

(c)

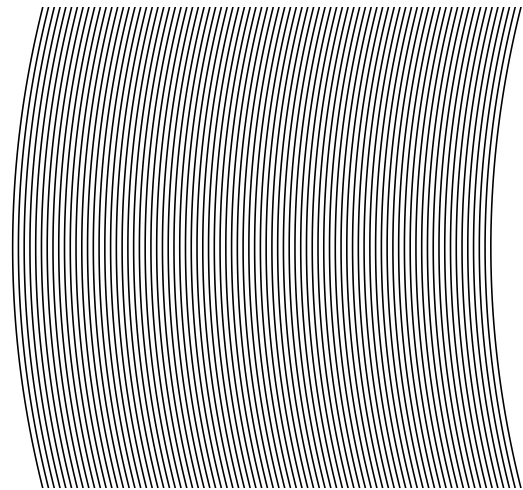

(d)

Figure 6.3(a)-(d) from the book: *The Theory of the Moiré Phenomenon Vol. II: Aperiodic Layers*, by I. Amidror, published by Springer, 2007.

(First layer only.)

(a)

(b)

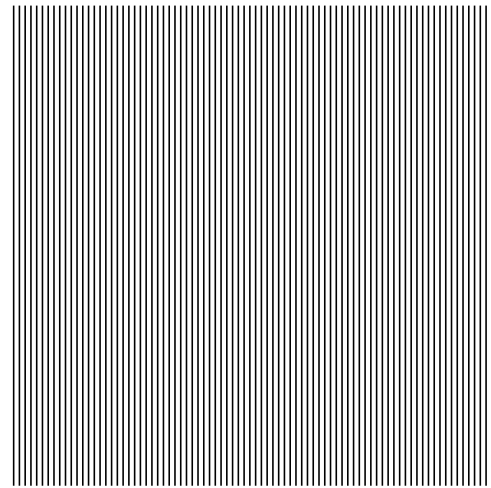
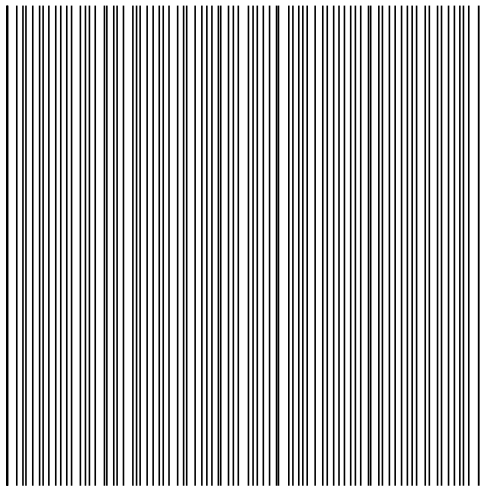

(c)

(d)

Figure 6.3(a)-(d) from the book: *The Theory of the Moiré Phenomenon Vol. II: Aperiodic Layers*, by I. Amidror, published by Springer, 2007.

(Second layer only.)

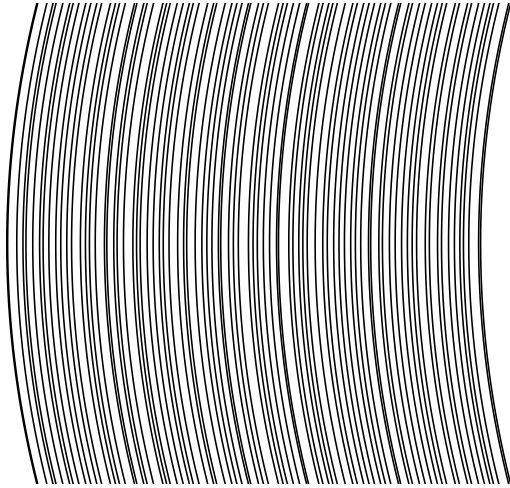

(a)

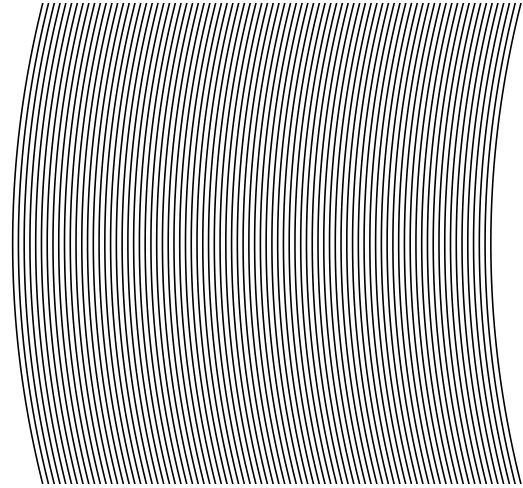

(b)

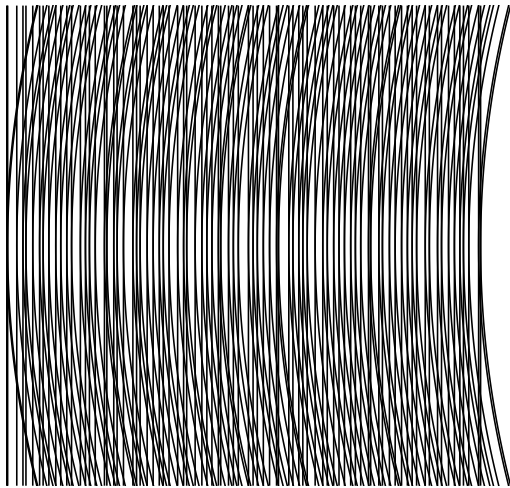

(c)

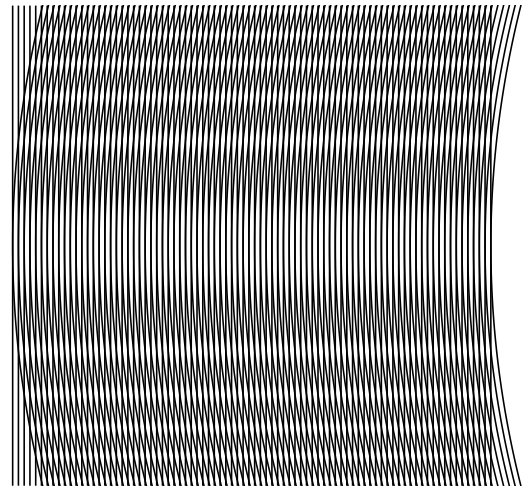

(d)

Figure 6.3(a)-(d) from the book: *The Theory of the Moiré Phenomenon Vol. II: Aperiodic Layers*, by I. Amidror, published by Springer, 2007.

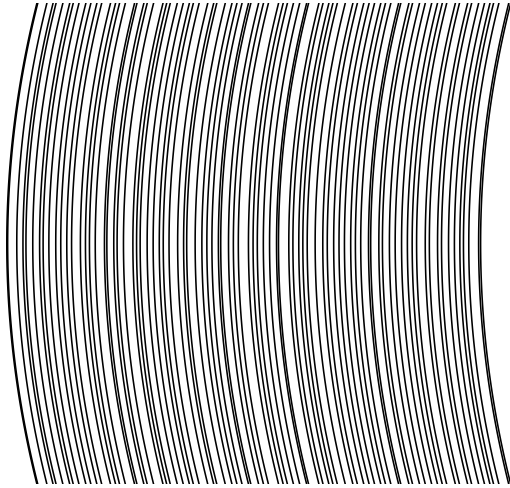

(a)

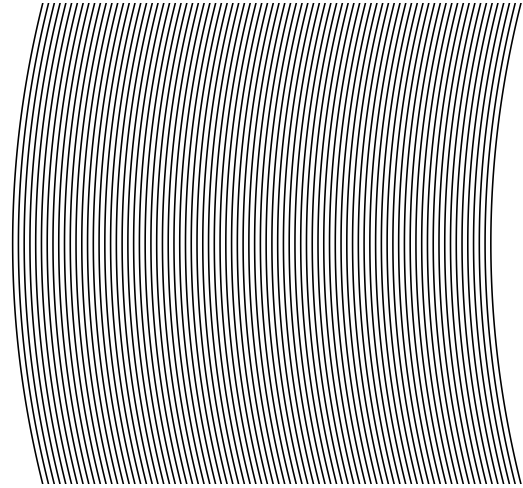

(b)

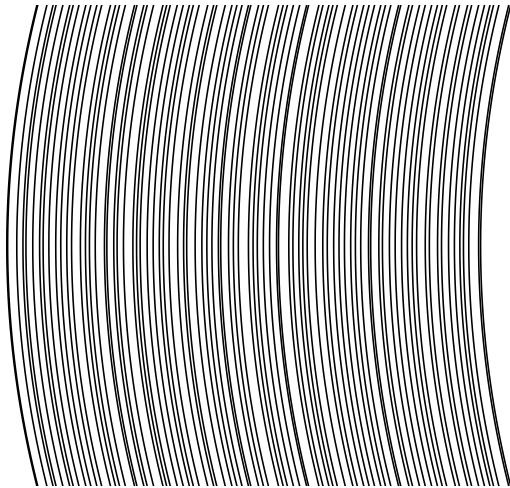

(c)

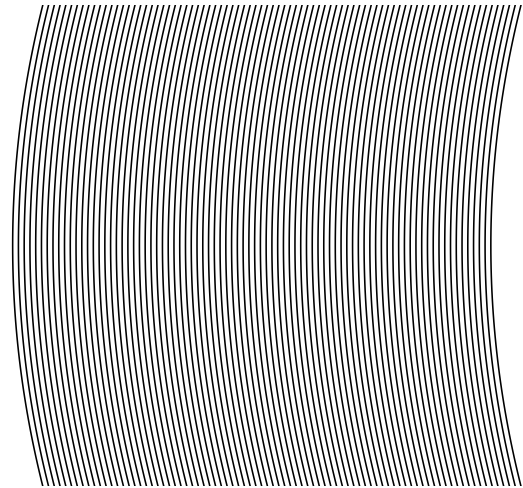

(d)

Figure 6.6(a)-(d) from the book: *The Theory of the Moiré Phenomenon Vol. II: Aperiodic Layers*, by I. Amidror, published by Springer, 2007.

(First layer only.)

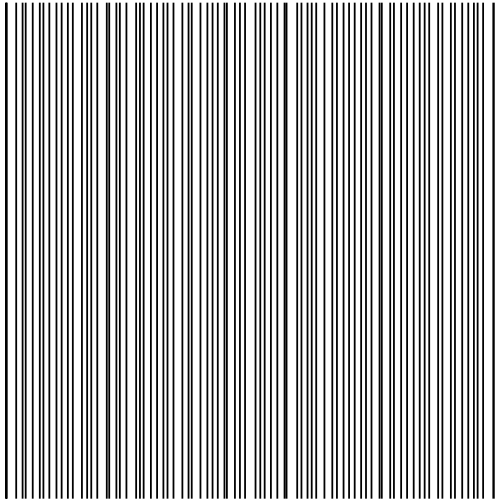

(a)

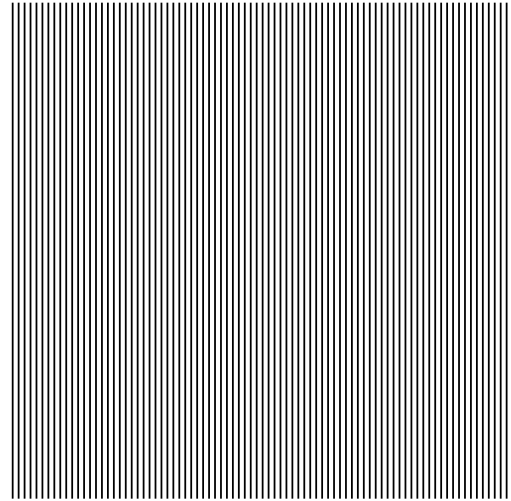

(b)

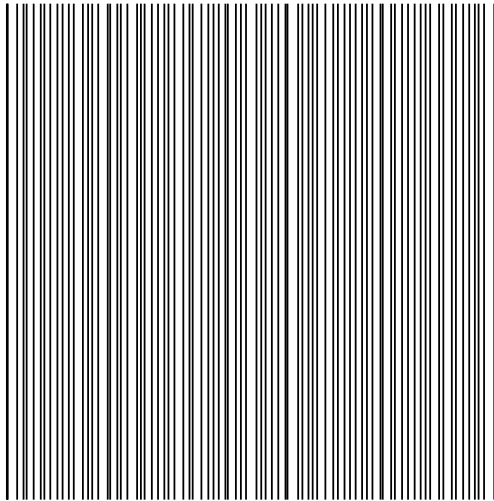

(c)

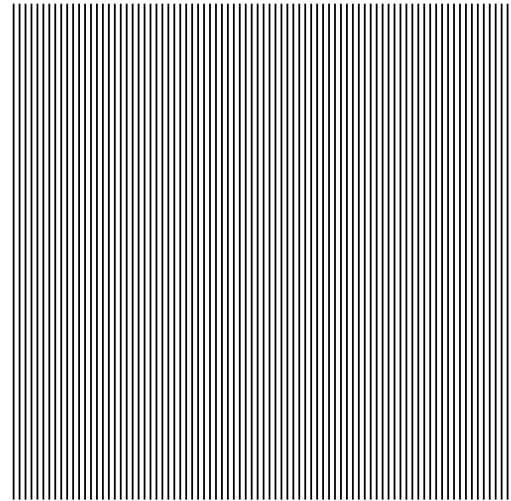

(d)

Figure 6.6(a)-(d) from the book: *The Theory of the Moiré Phenomenon Vol. II: Aperiodic Layers*, by I. Amidror, published by Springer, 2007.

(Second layer only.)

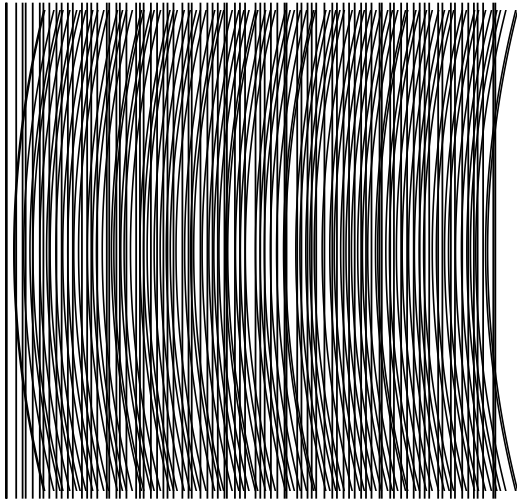

(a)

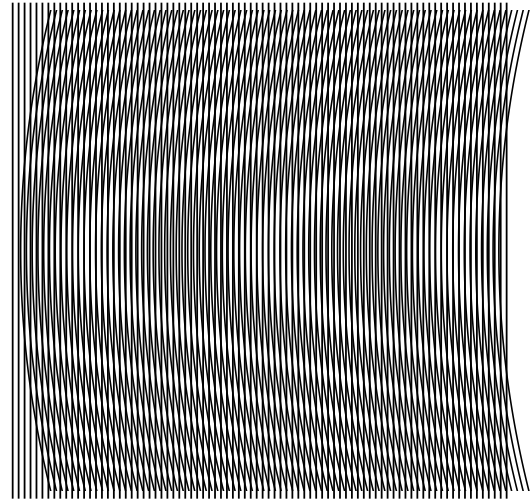

(b)

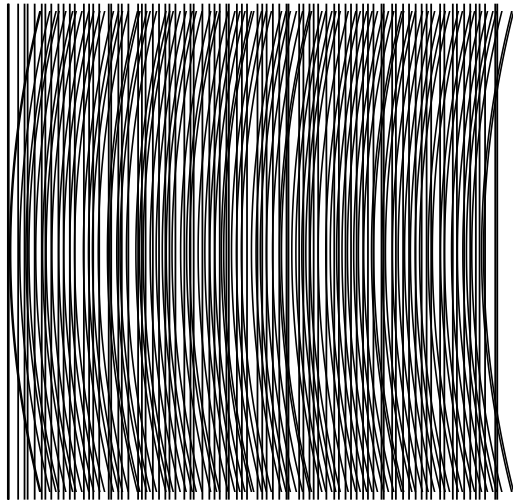

(c)

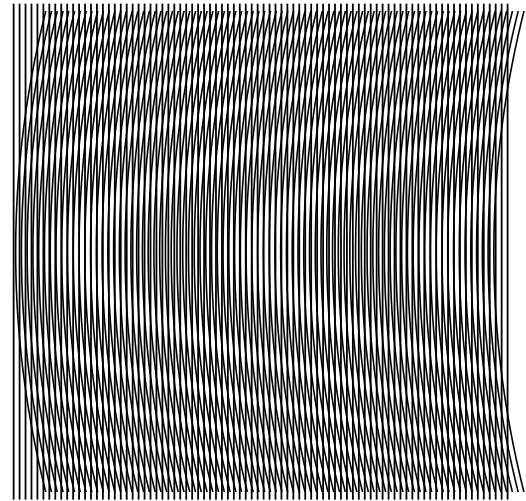

(d)

Figure 6.6(a)-(d) from the book: *The Theory of the Moiré Phenomenon Vol. II: Aperiodic Layers*, by I. Amidror, published by Springer, 2007.

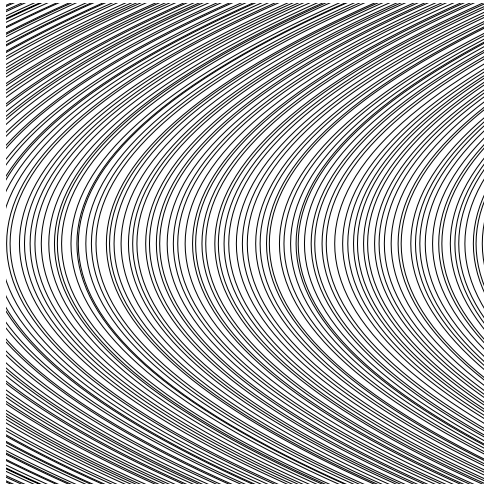

(a)

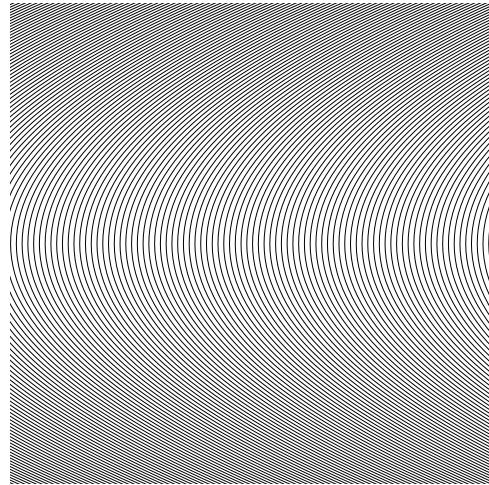

(b)

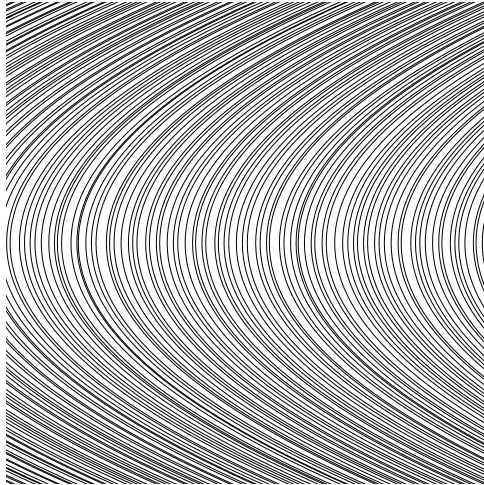

(c)

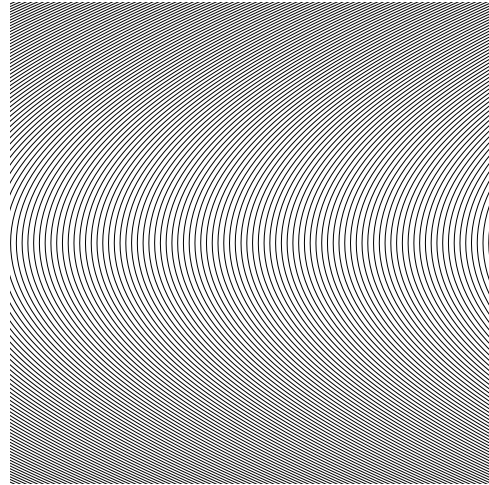

(d)

Figure 6.8(a)-(d) from the book: *The Theory of the Moiré Phenomenon Vol. II: Aperiodic Layers*, by I. Amidror, published by Springer, 2007.

(First layer only.)

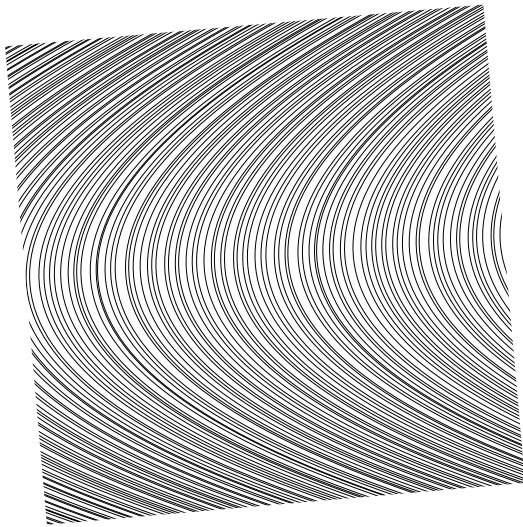

(a)

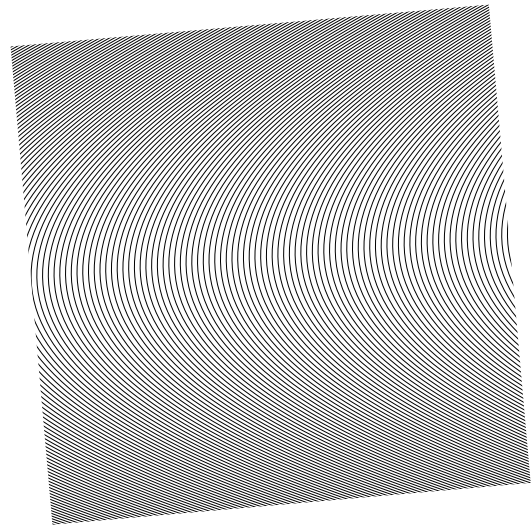

(b)

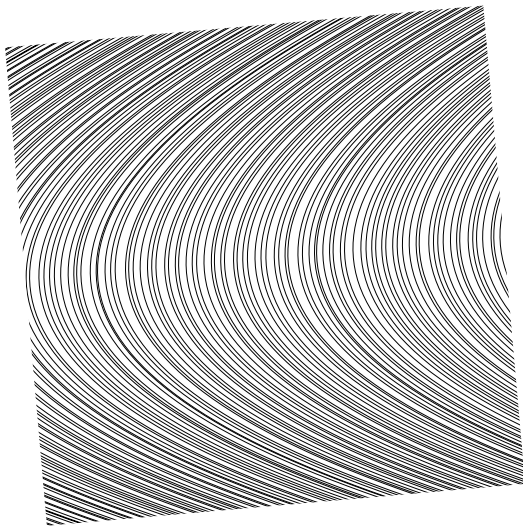

(c)

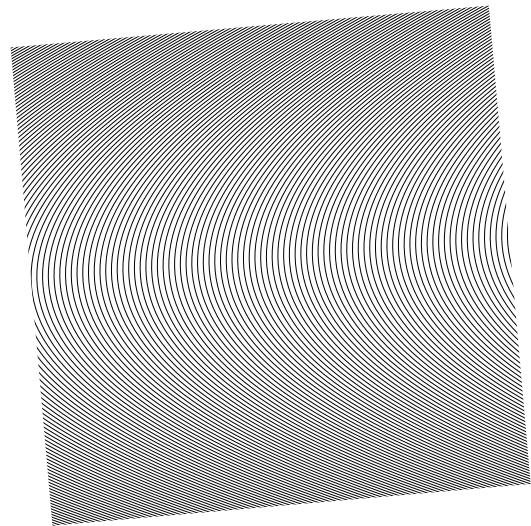

(d)

Figure 6.8(a)-(d) from the book: *The Theory of the Moiré Phenomenon Vol. II: Aperiodic Layers*, by I. Amidror, published by Springer, 2007.

(Second layer only.)

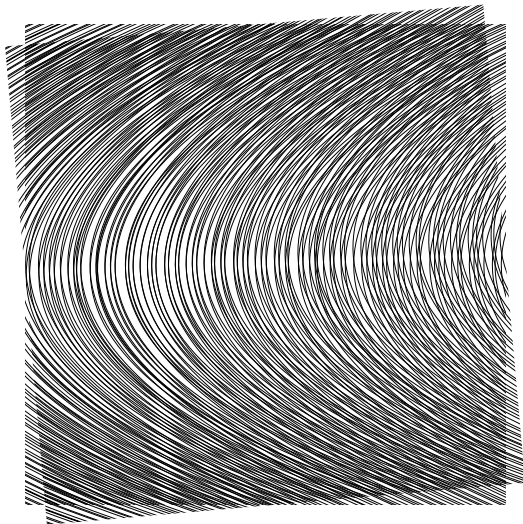

(a)

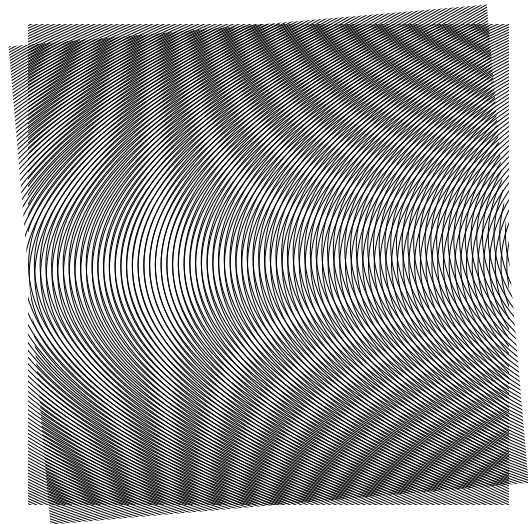

(b)

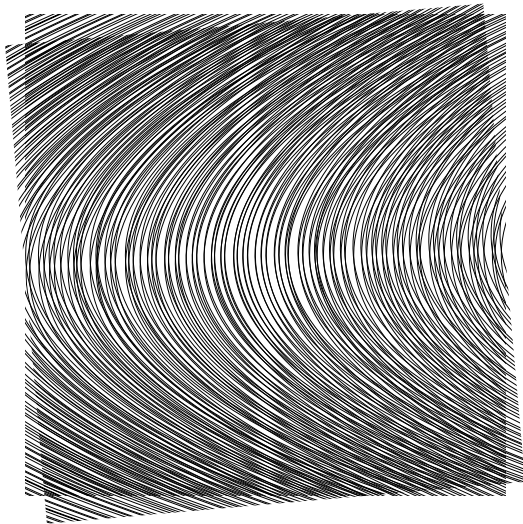

(c)

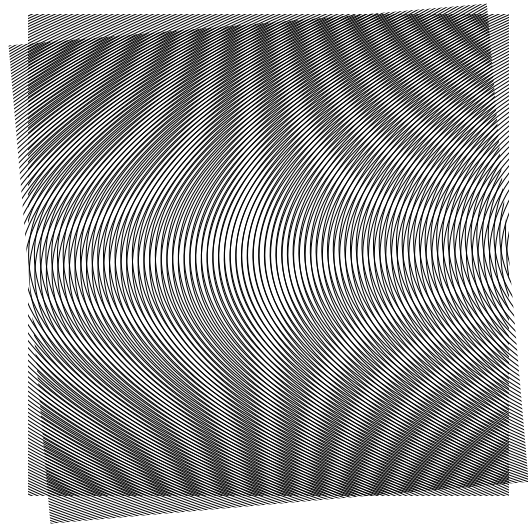

(d)

Figure 6.8(a)-(d) from the book: *The Theory of the Moiré Phenomenon Vol. II: Aperiodic Layers*, by I. Amidror, published by Springer, 2007.

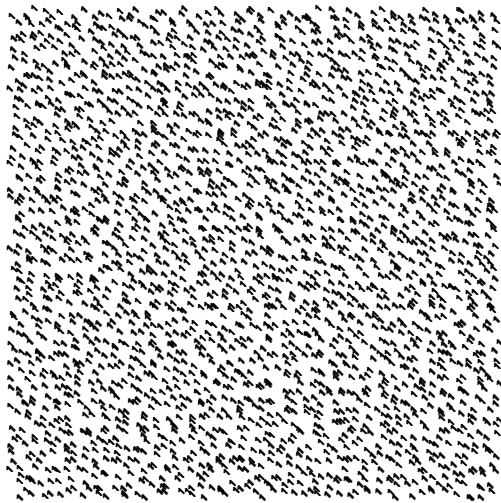

(a)

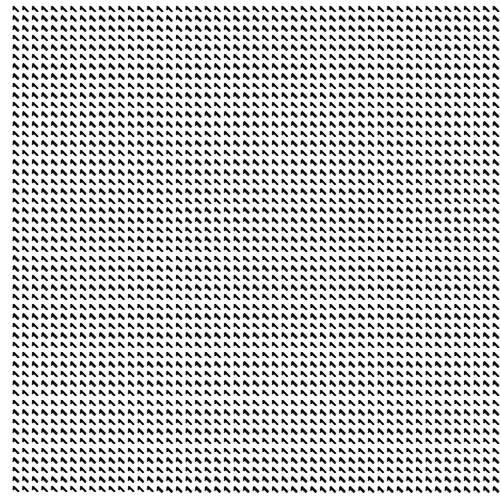

(b)

Figure 7.1(a)-(b) from the book: *The Theory of the Moiré Phenomenon Vol. II: Aperiodic Layers*, by I. Amidror, published by Springer, 2007.

(First layer only.)

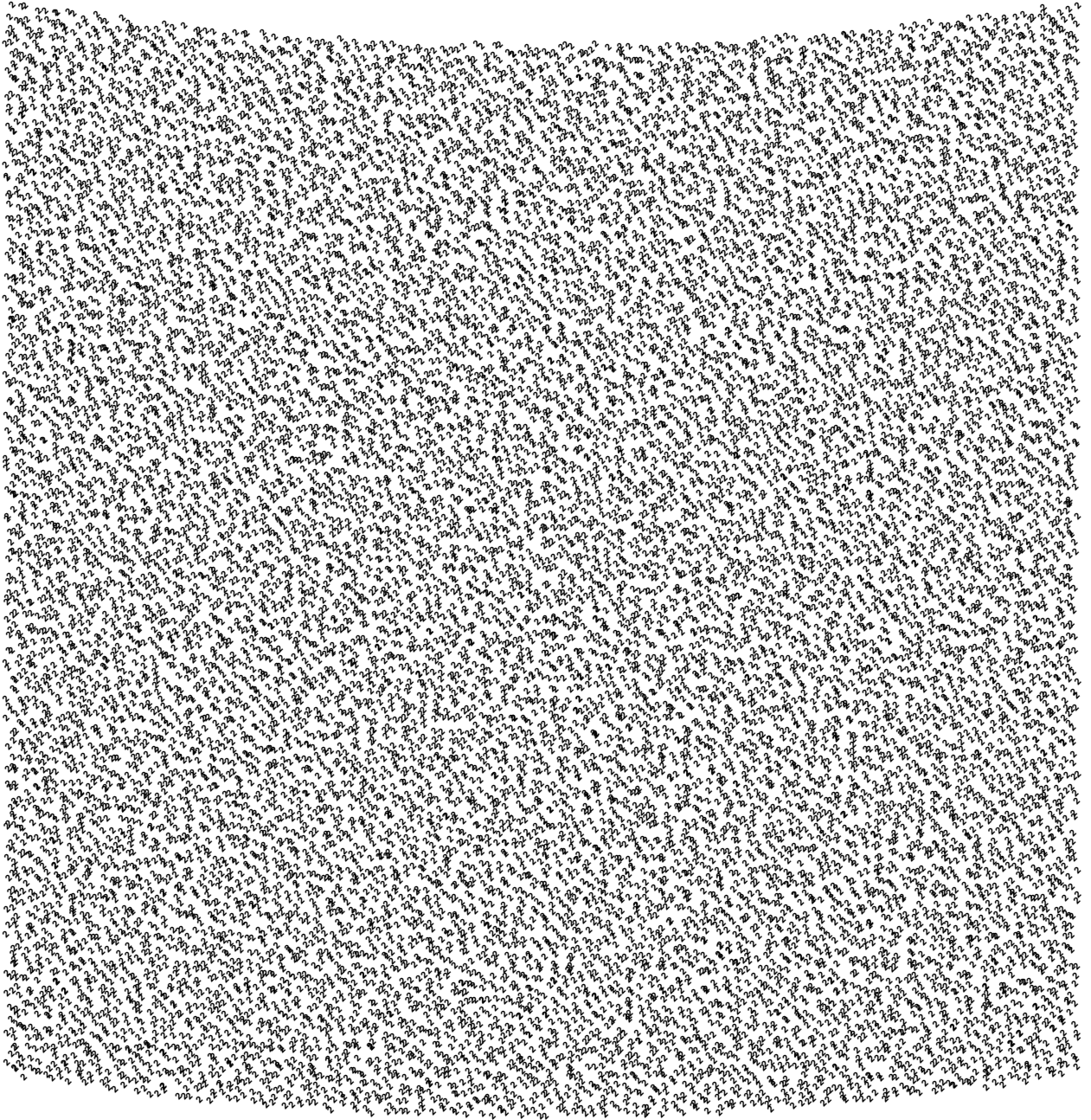

Figure 7.12(a) from the book: *The Theory of the Moiré Phenomenon*
Vol. II: Aperiodic Layers, by I. Amidror, published by Springer, 2007.

(First layer only.)

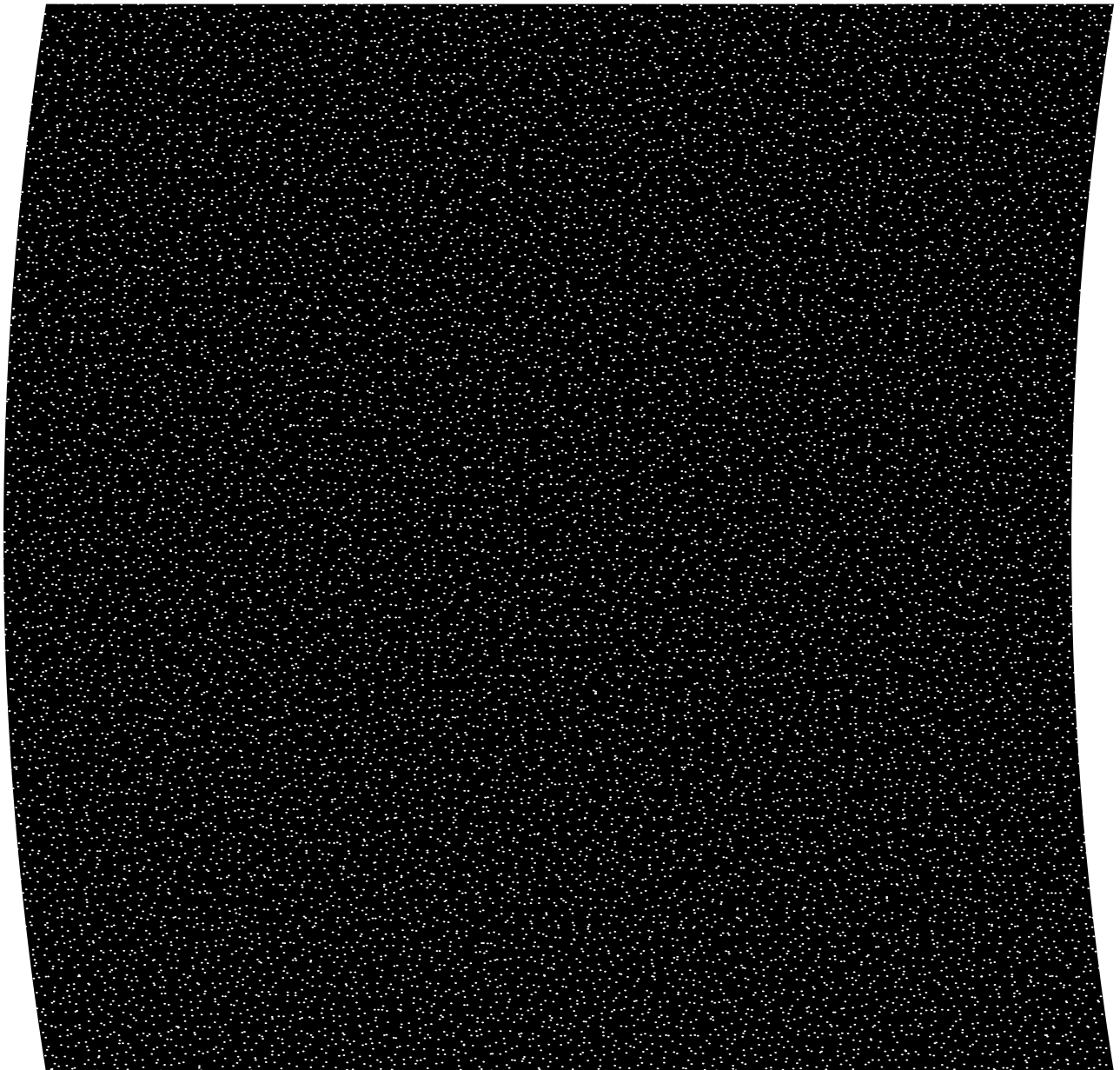

Figure 7.12(a) from the book: *The Theory of the Moiré Phenomenon*
Vol. II: Aperiodic Layers, by I. Amidror, published by Springer, 2007.

(Second layer only.)

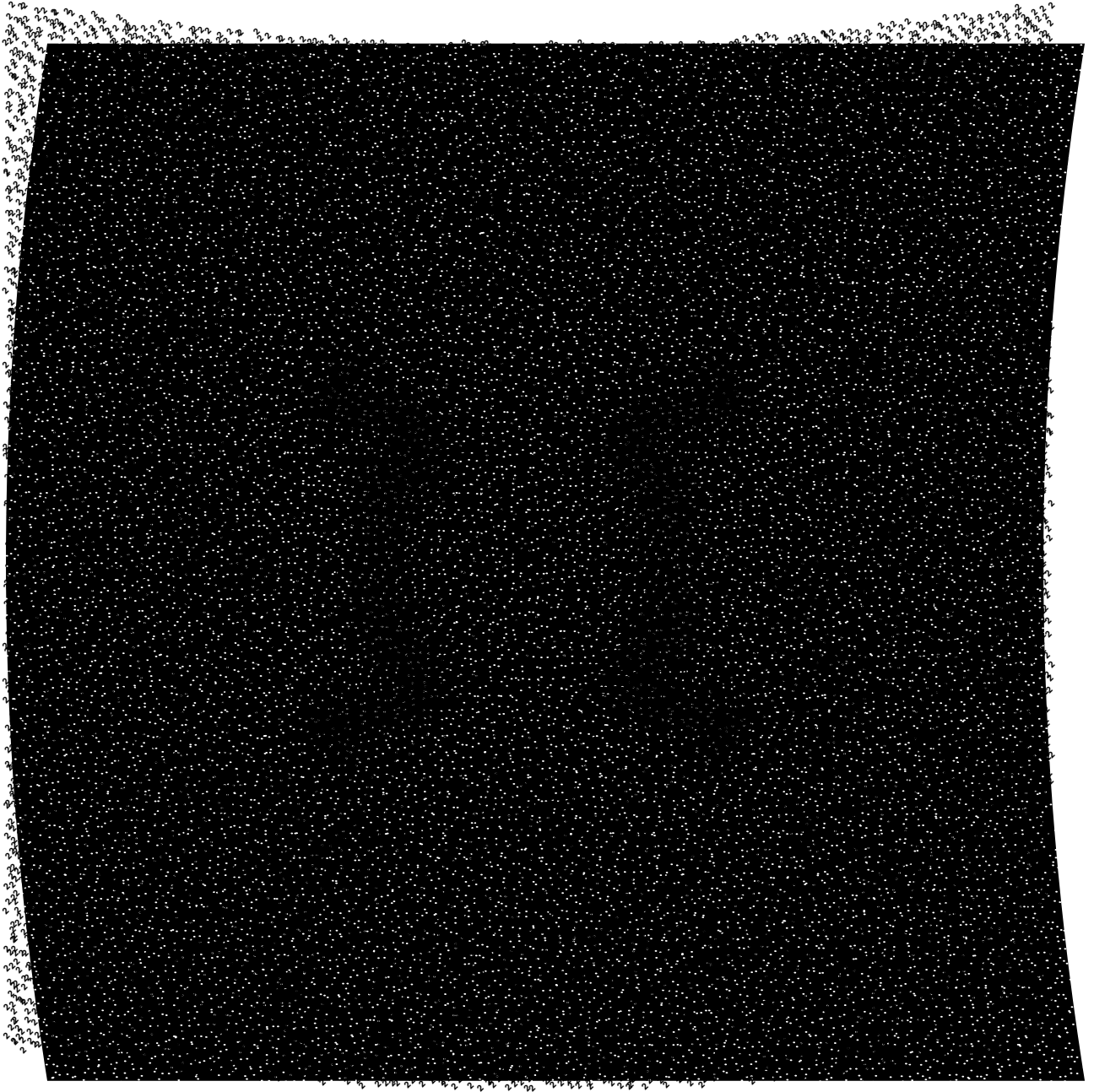

Figure 7.12(a) from the book: *The Theory of the Moiré Phenomenon*
Vol. II: Aperiodic Layers, by I. Amidror, published by Springer, 2007.

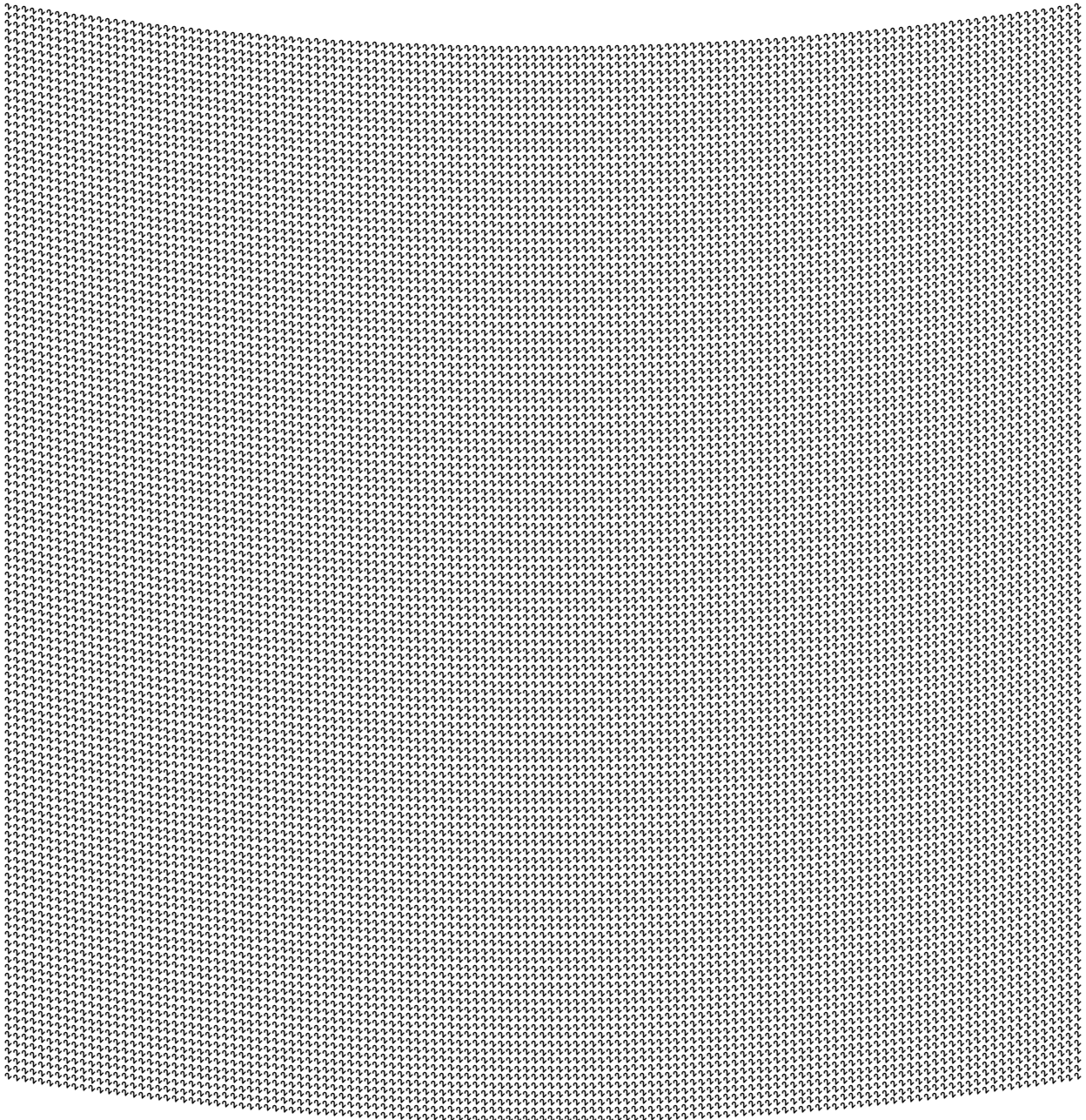

Figure 7.12(b) from the book: *The Theory of the Moiré Phenomenon*
Vol. II: Aperiodic Layers, by I. Amidror, published by Springer, 2007.

(First layer only.)

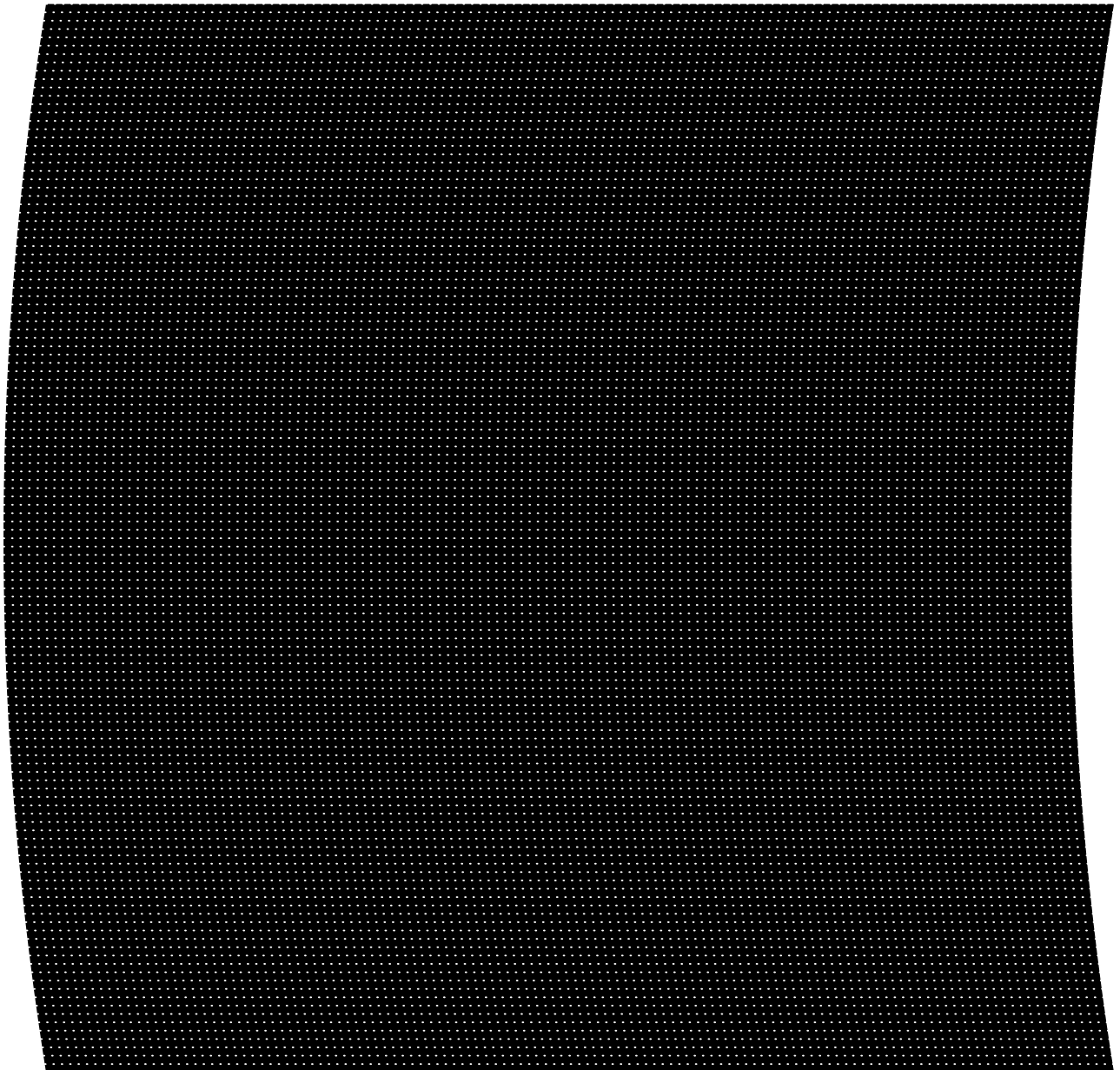

Figure 7.12(b) from the book: *The Theory of the Moiré Phenomenon*
Vol. II: Aperiodic Layers, by I. Amidror, published by Springer, 2007.

(Second layer only.)

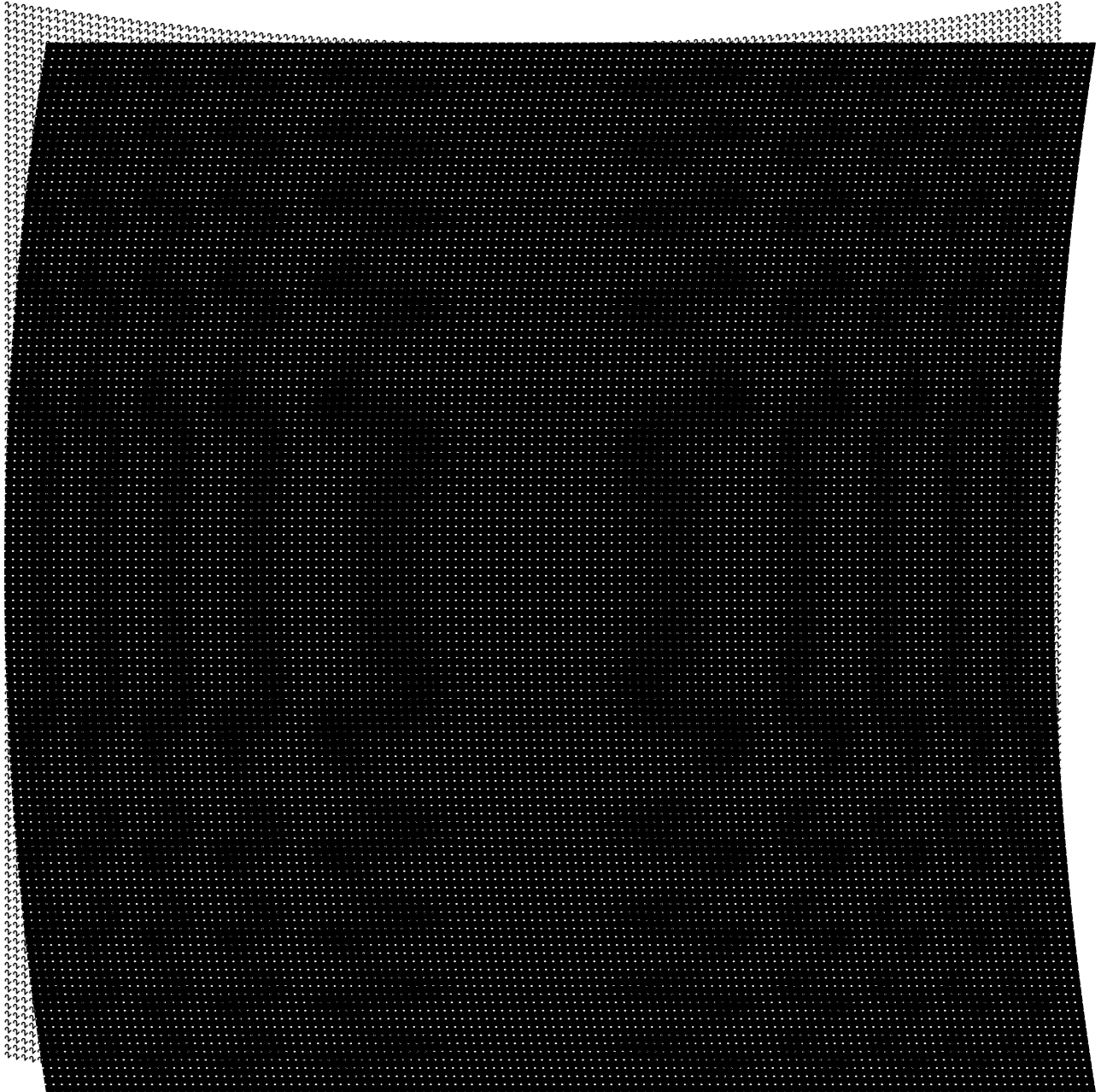
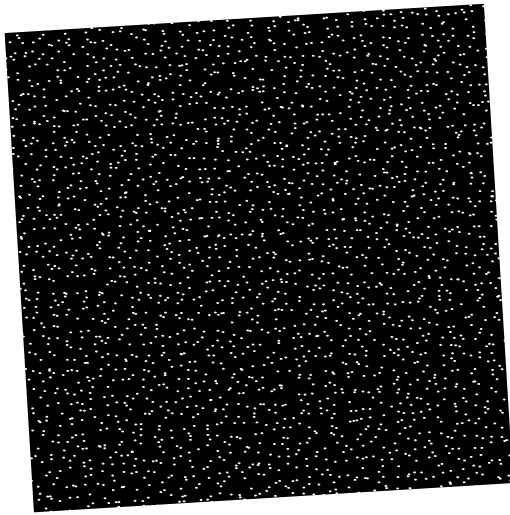
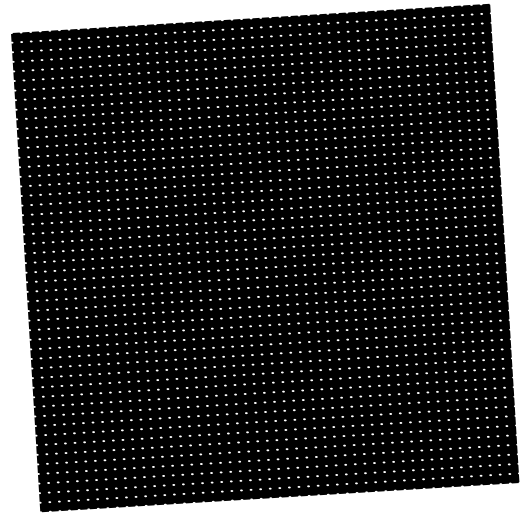

Figure 7.12(b) from the book: *The Theory of the Moiré Phenomenon Vol. II: Aperiodic Layers*, by I. Amidror, published by Springer, 2007.



(a)



(b)

Figure 7.1(a)-(b) from the book: *The Theory of the Moiré Phenomenon Vol. II: Aperiodic Layers*, by I. Amidror, published by Springer, 2007.

(Second layer only.)

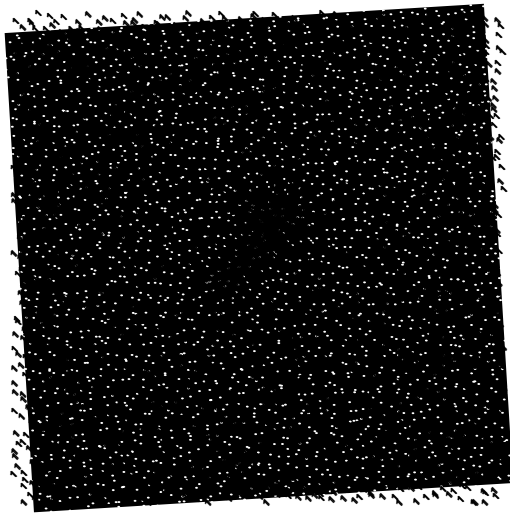

(a)

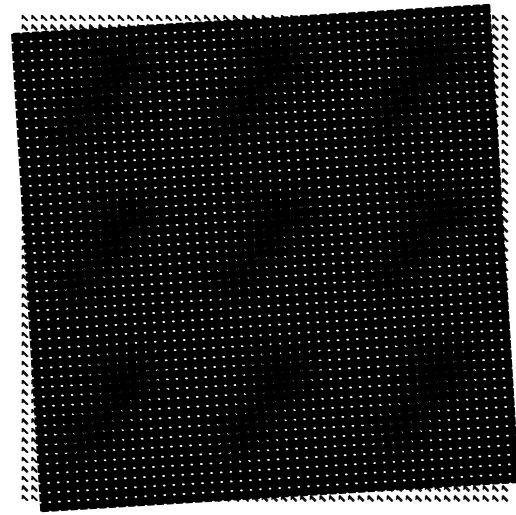

(b)

Figure 7.1(a)-(b) from the book: *The Theory of the Moiré Phenomenon Vol. II: Aperiodic Layers*, by I. Amidror, published by Springer, 2007.

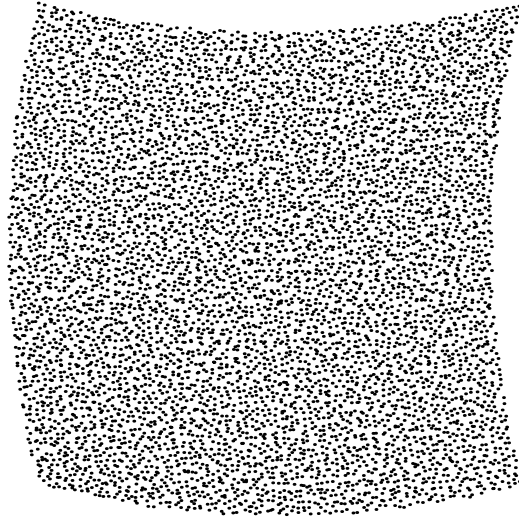

Figure A.1 from the book: *The Theory of the Moiré Phenomenon*
Vol. II: Aperiodic Layers, by I. Amidror, published by Springer, 2007.

(First layer only.)

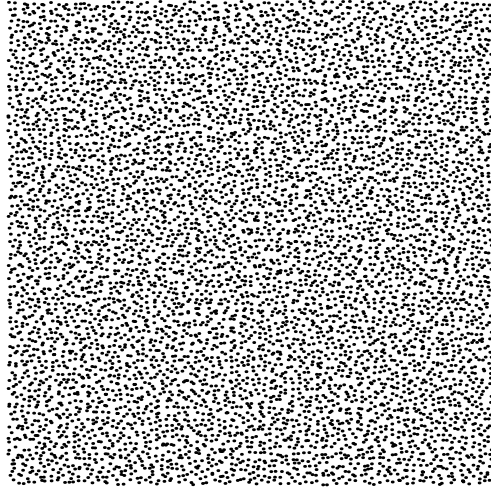

Figure A.1 from the book: *The Theory of the Moiré Phenomenon*
Vol. II: Aperiodic Layers, by I. Amidror, published by Springer, 2007.

(Second layer only.)

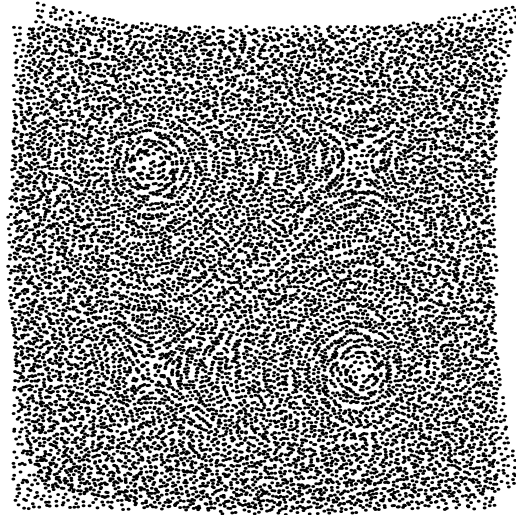

Figure A.1 from the book: *The Theory of the Moiré Phenomenon*
Vol. II: Aperiodic Layers, by I. Amidror, published by Springer, 2007.

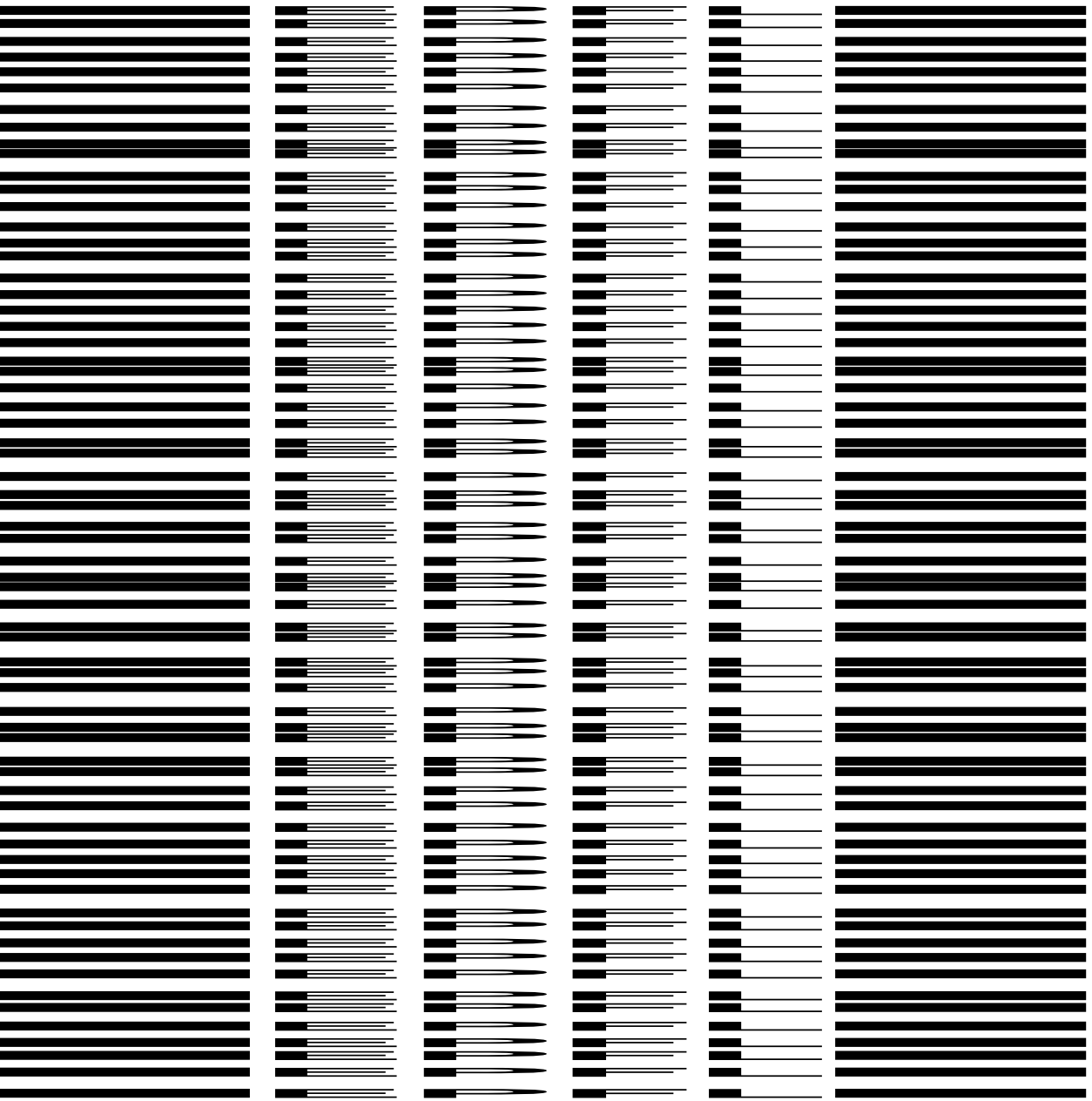

Figure H.1(a) from the book: *The Theory of the Moiré Phenomenon*
Vol. II: Aperiodic Layers, by I. Amidror, published by Springer, 2007.

(First layer only.)

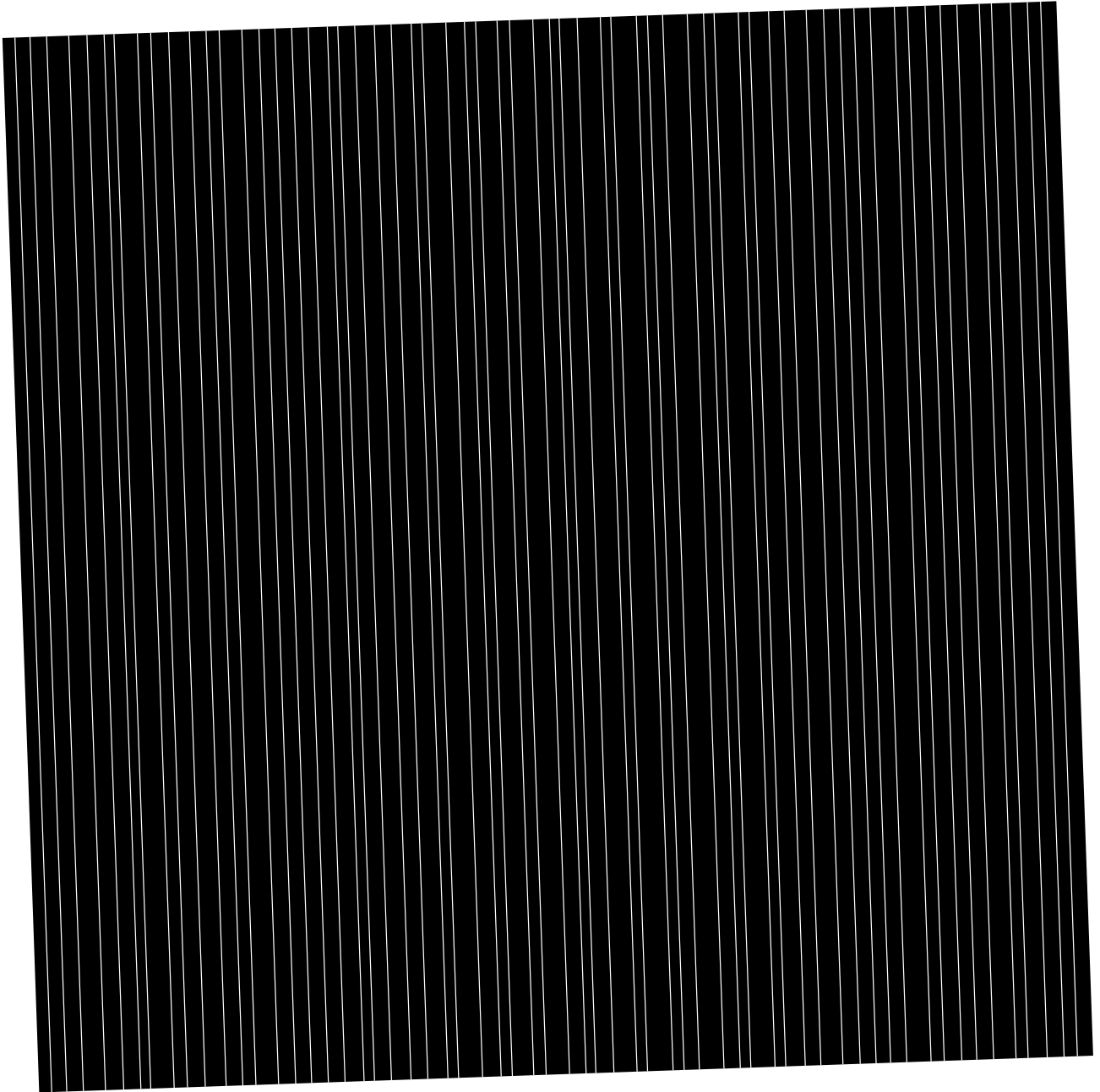

Figure H.1(a) from the book: *The Theory of the Moiré Phenomenon*
Vol. II: Aperiodic Layers, by I. Amidror, published by Springer, 2007.

(Second layer only.)

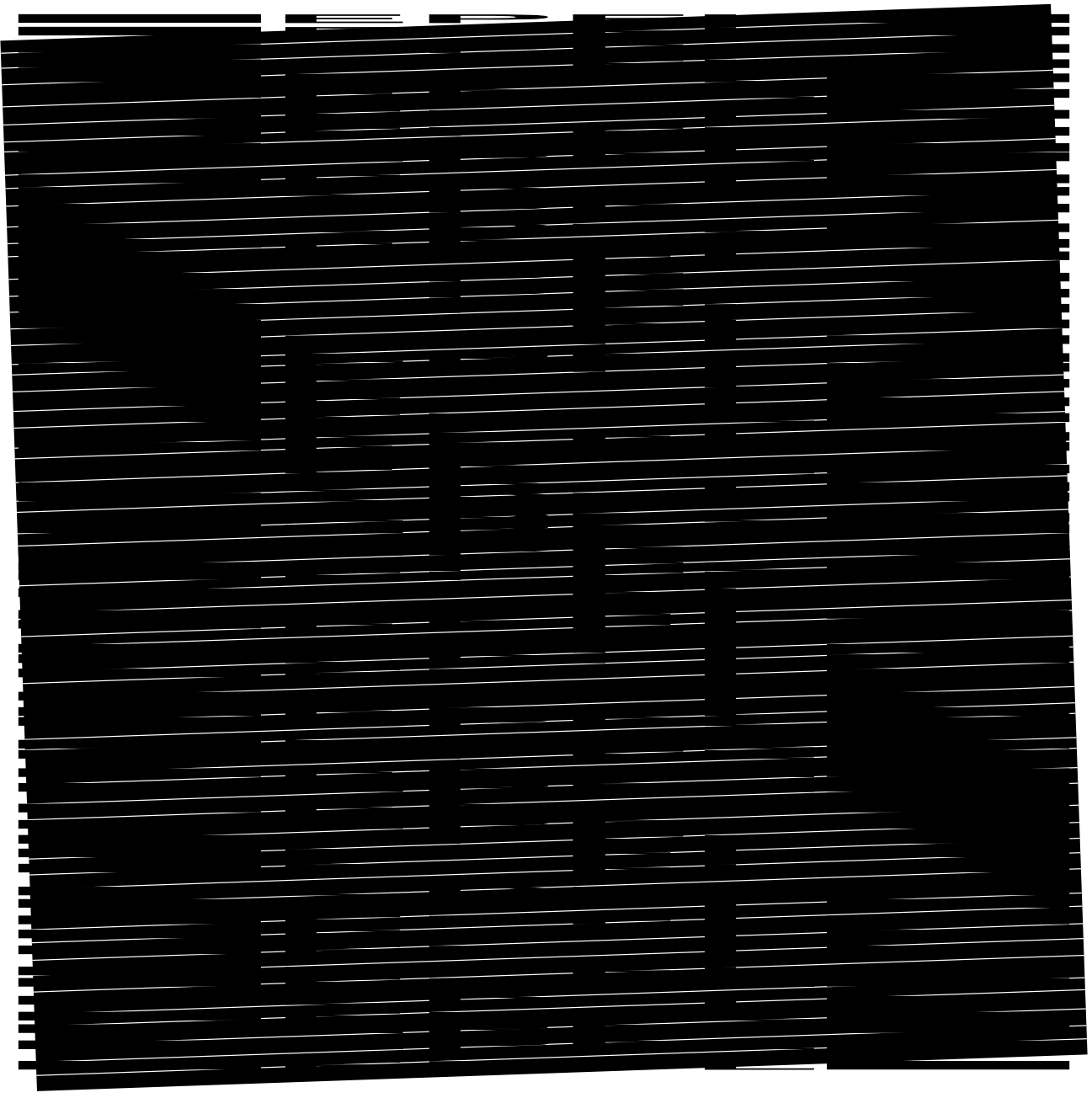

Figure H.1(a) from the book: *The Theory of the Moiré Phenomenon*
Vol. II: Aperiodic Layers, by I. Amidror, published by Springer, 2007.

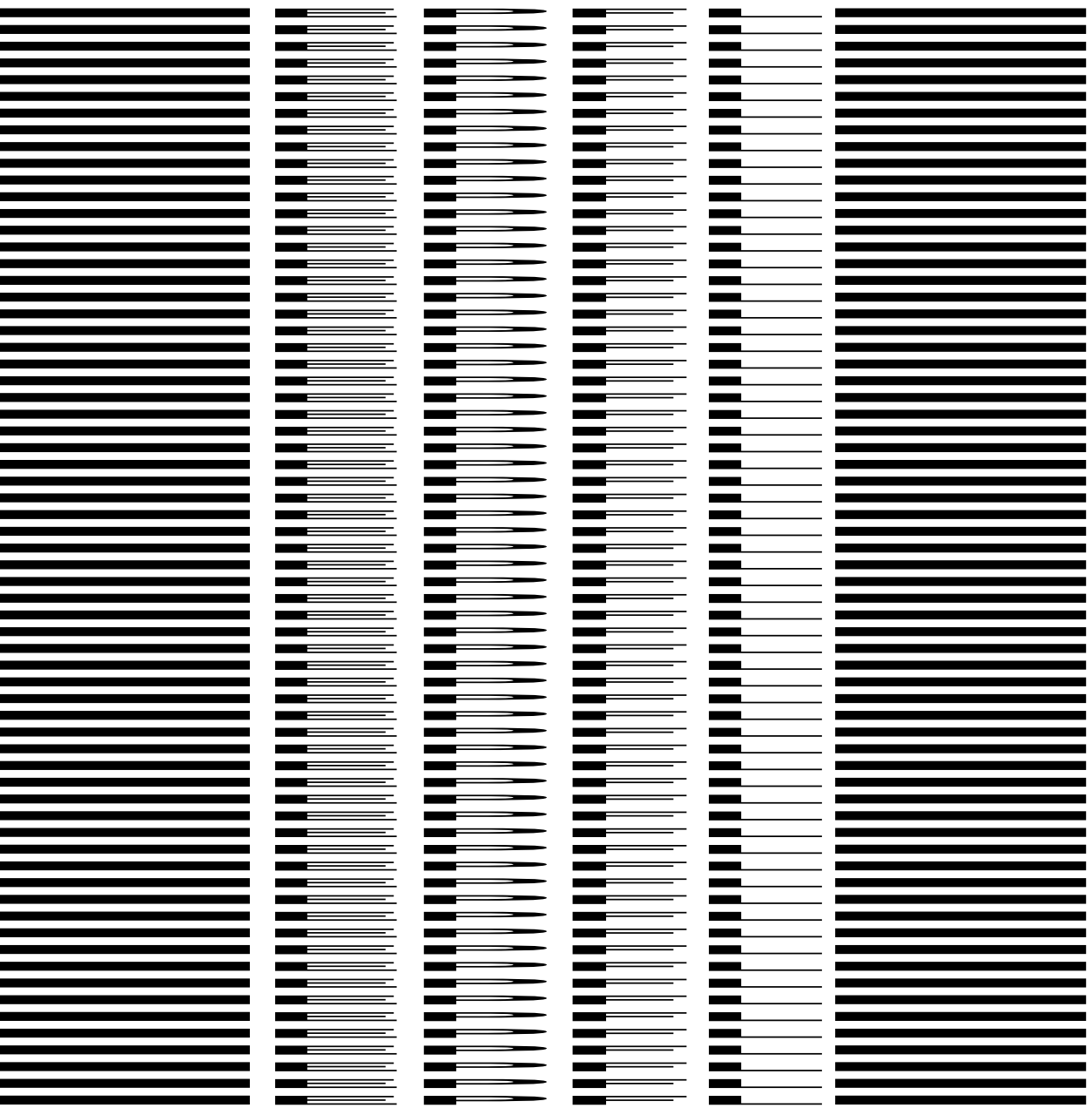

Figure H.1(b) from the book: *The Theory of the Moiré Phenomenon*
Vol. II: Aperiodic Layers, by I. Amidror, published by Springer, 2007.
(First layer only.)

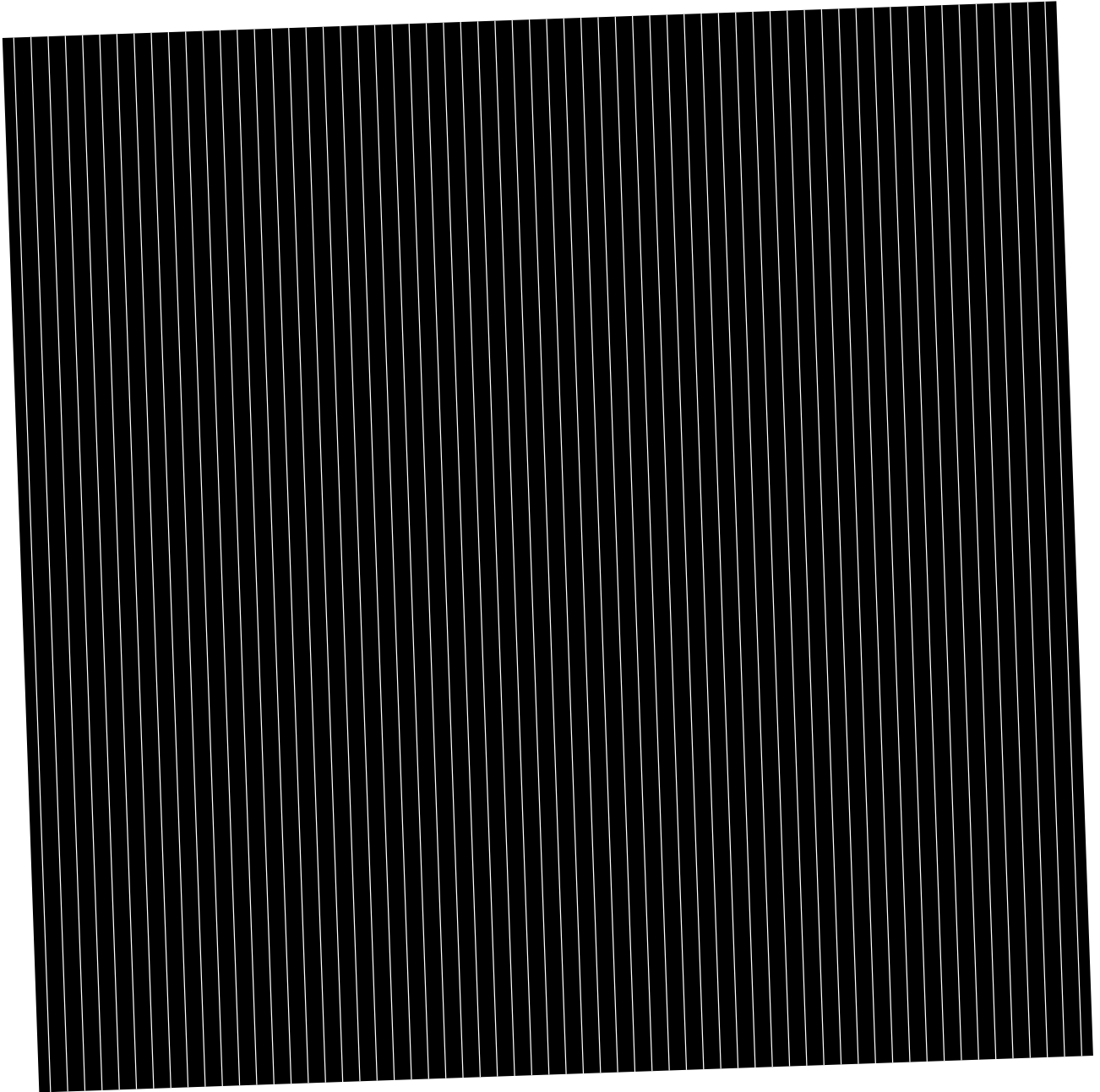

Figure H.1(b) from the book: *The Theory of the Moiré Phenomenon*
Vol. II: Aperiodic Layers, by I. Amidror, published by Springer, 2007.

(Second layer only.)



Figure H.1(b) from the book: *The Theory of the Moiré Phenomenon*
Vol. II: Aperiodic Layers, by I. Amidror, published by Springer, 2007.

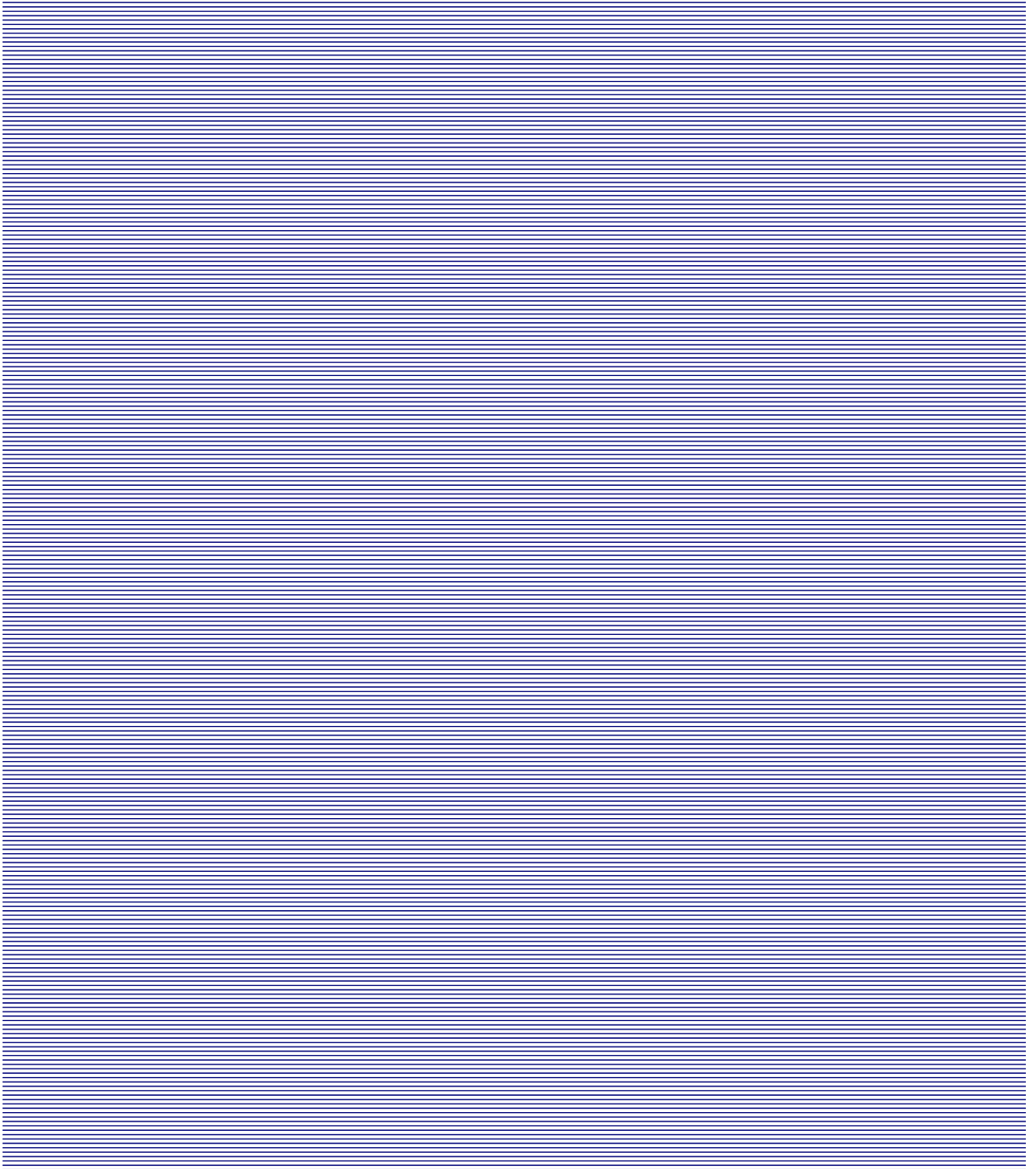

Figure **gratb** from the Moiré Demonstration Kit
accompanying the book: *The Theory of the Moiré Phenomenon*
by I. Amidror, published by Kluwer Academic Publishers, 1999.

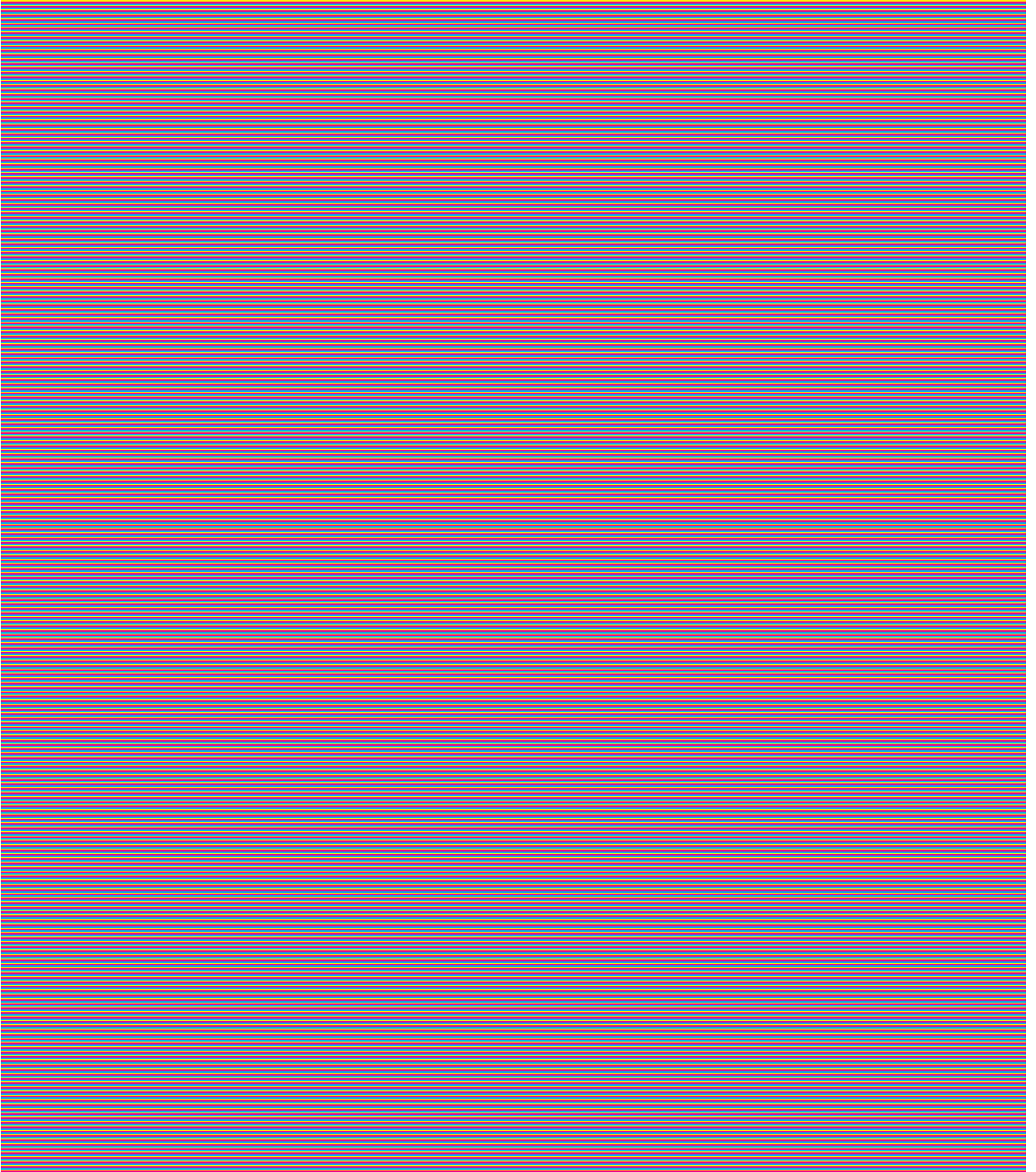

Figure **gratcmy** from the Moiré Demonstration Kit
accompanying the book: *The Theory of the Moiré Phenomenon*
by I. Amidror, published by Kluwer Academic Publishers, 1999.

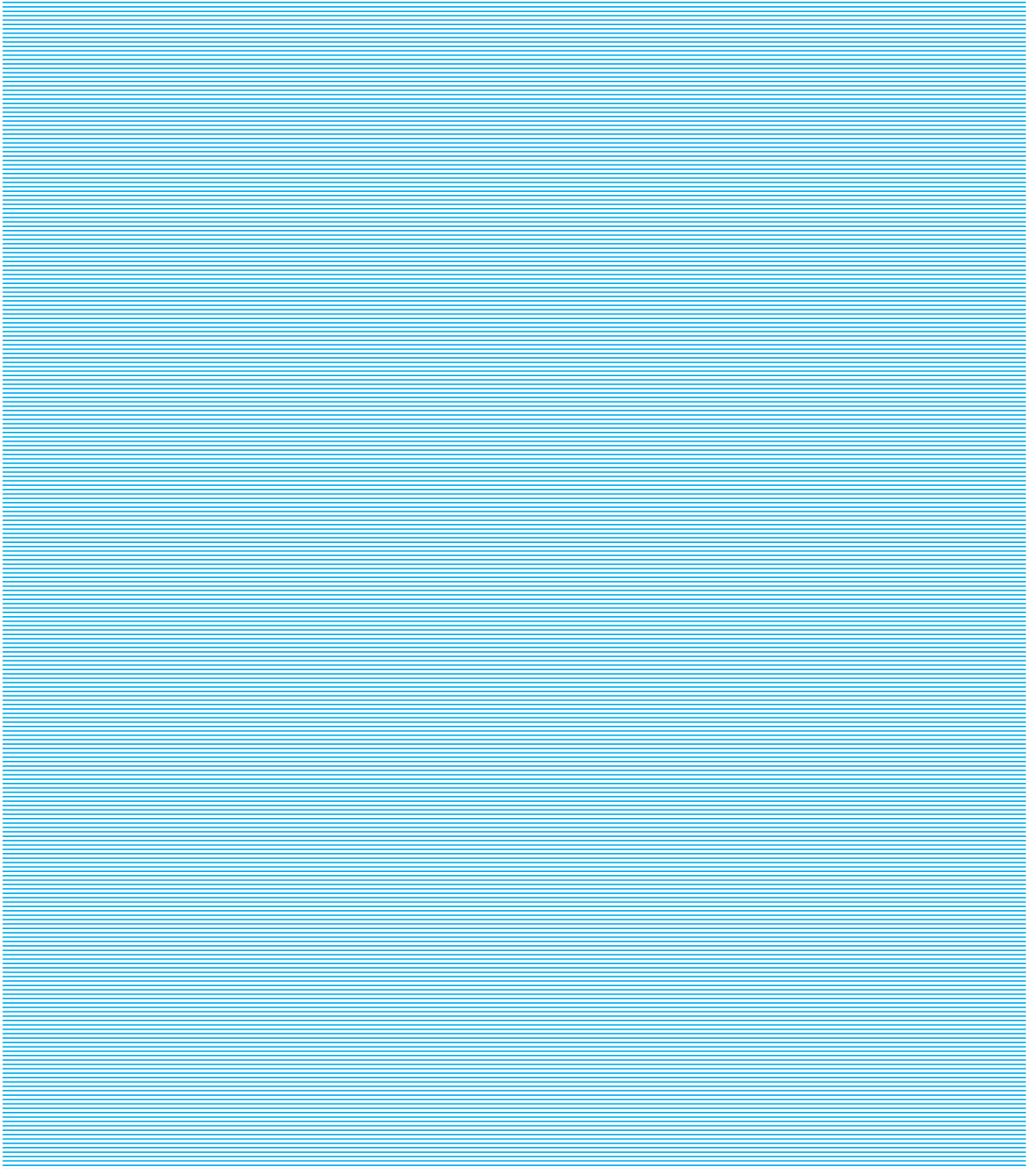

Figure **gratc** from the Moiré Demonstration Kit
accompanying the book: *The Theory of the Moiré Phenomenon*
by I. Amidror, published by Kluwer Academic Publishers, 1999.

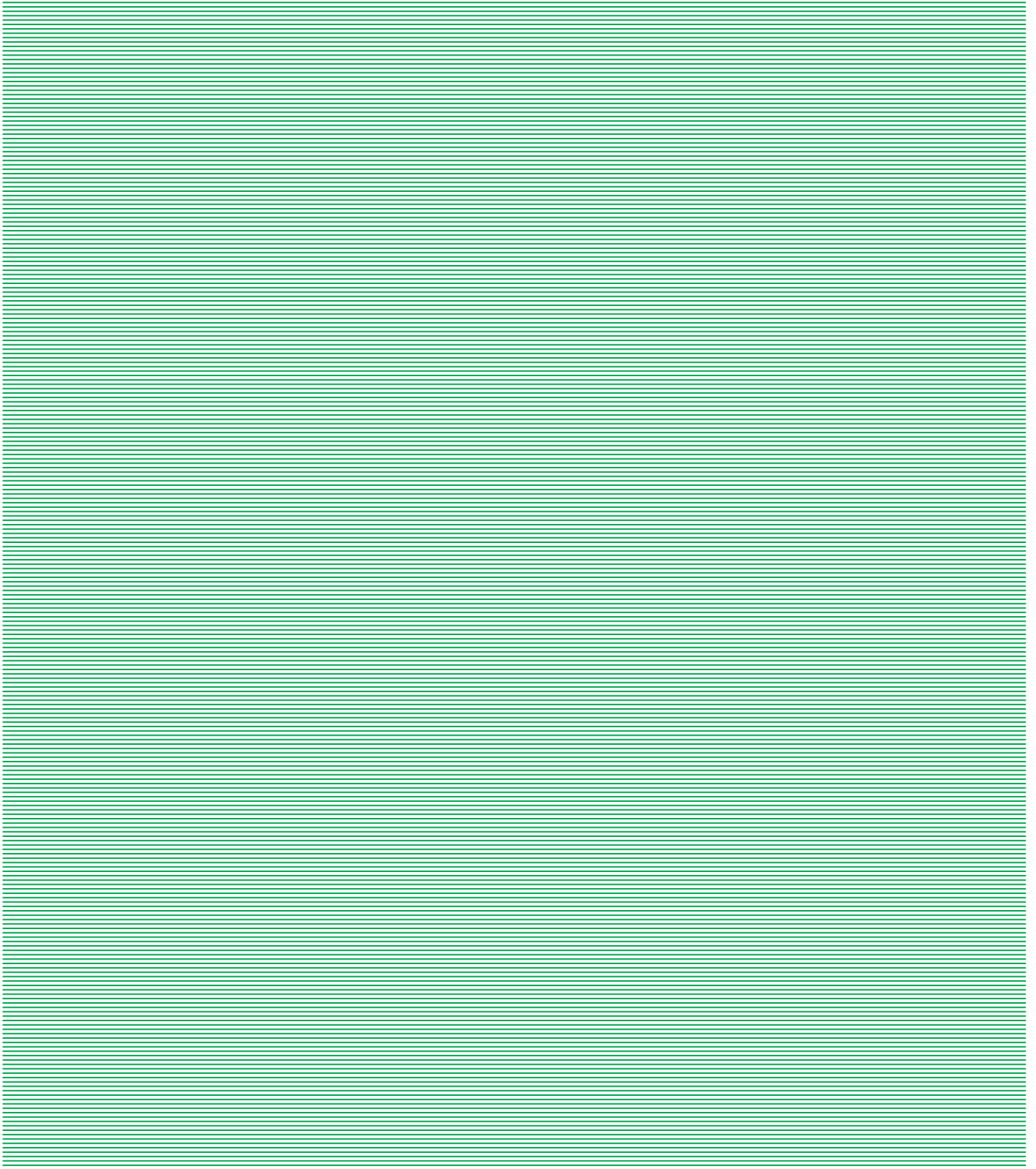

Figure **gratg** from the Moiré Demonstration Kit
accompanying the book: *The Theory of the Moiré Phenomenon*
by I. Amidror, published by Kluwer Academic Publishers, 1999.

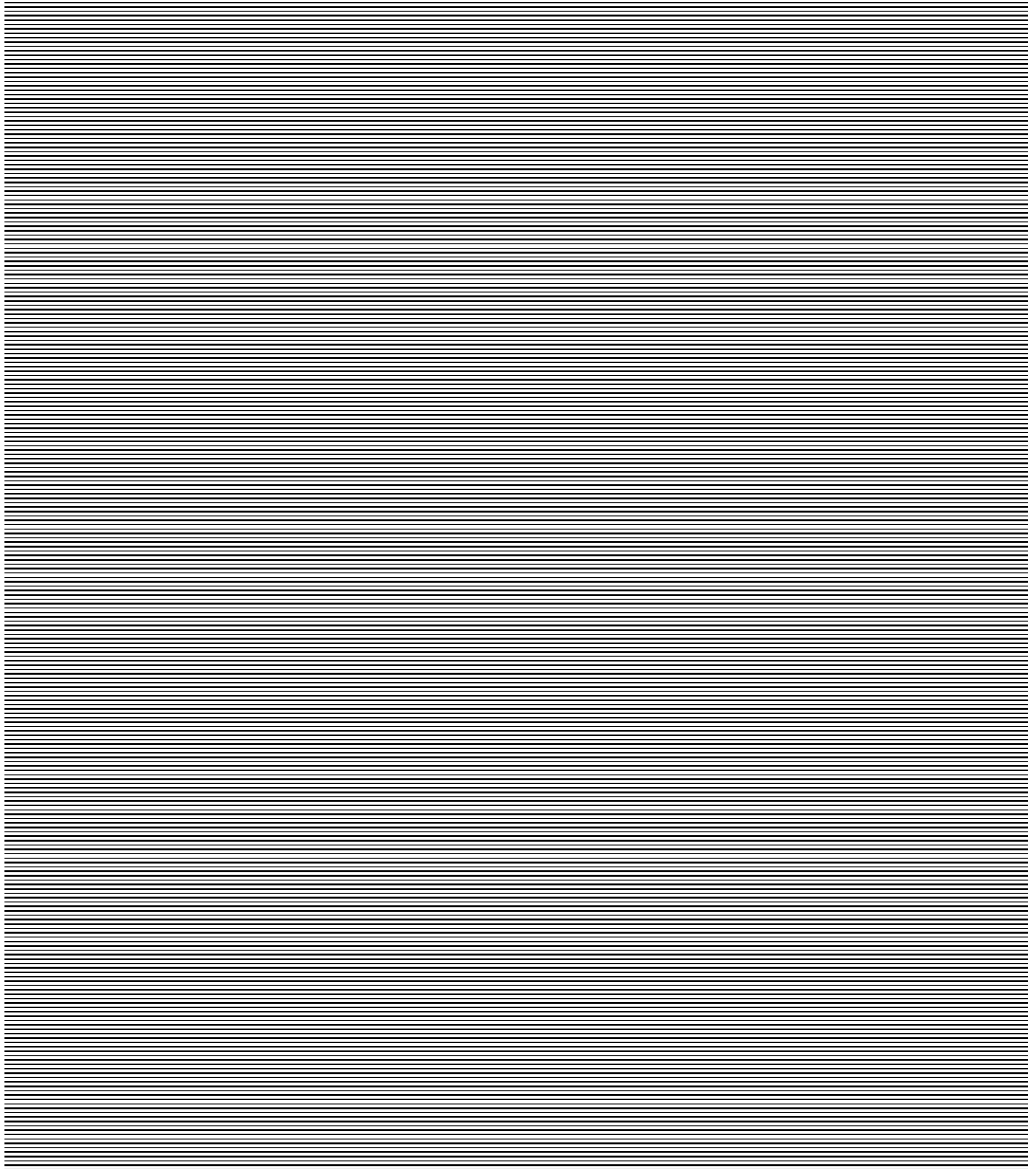

Figure **grating1** from the Moiré Demonstration Kit
accompanying the book: *The Theory of the Moiré Phenomenon*
by I. Amidror, published by Kluwer Academic Publishers, 1999.

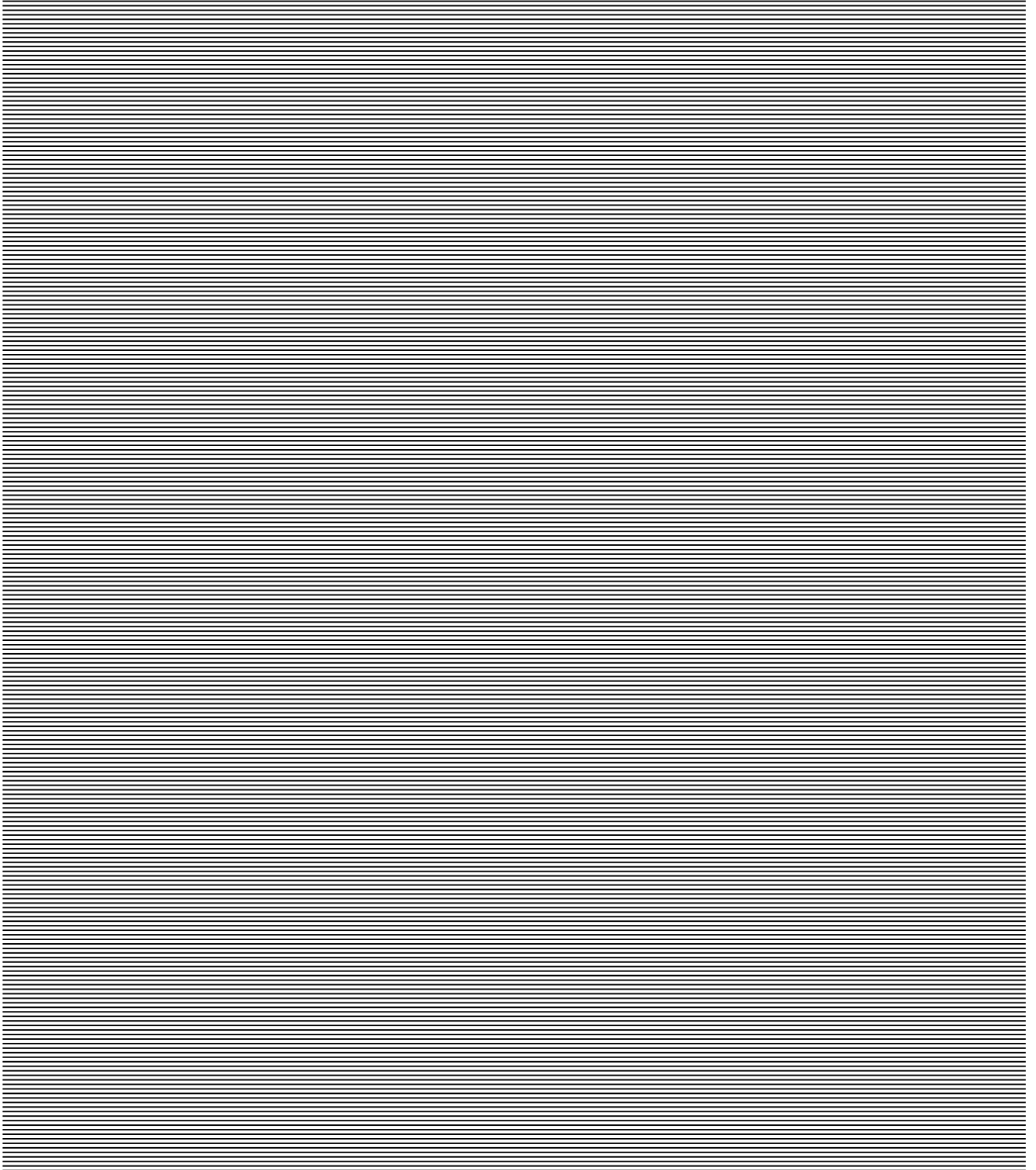

Figure **grating2** from the Moiré Demonstration Kit
accompanying the book: *The Theory of the Moiré Phenomenon*
by I. Amidror, published by Kluwer Academic Publishers, 1999.

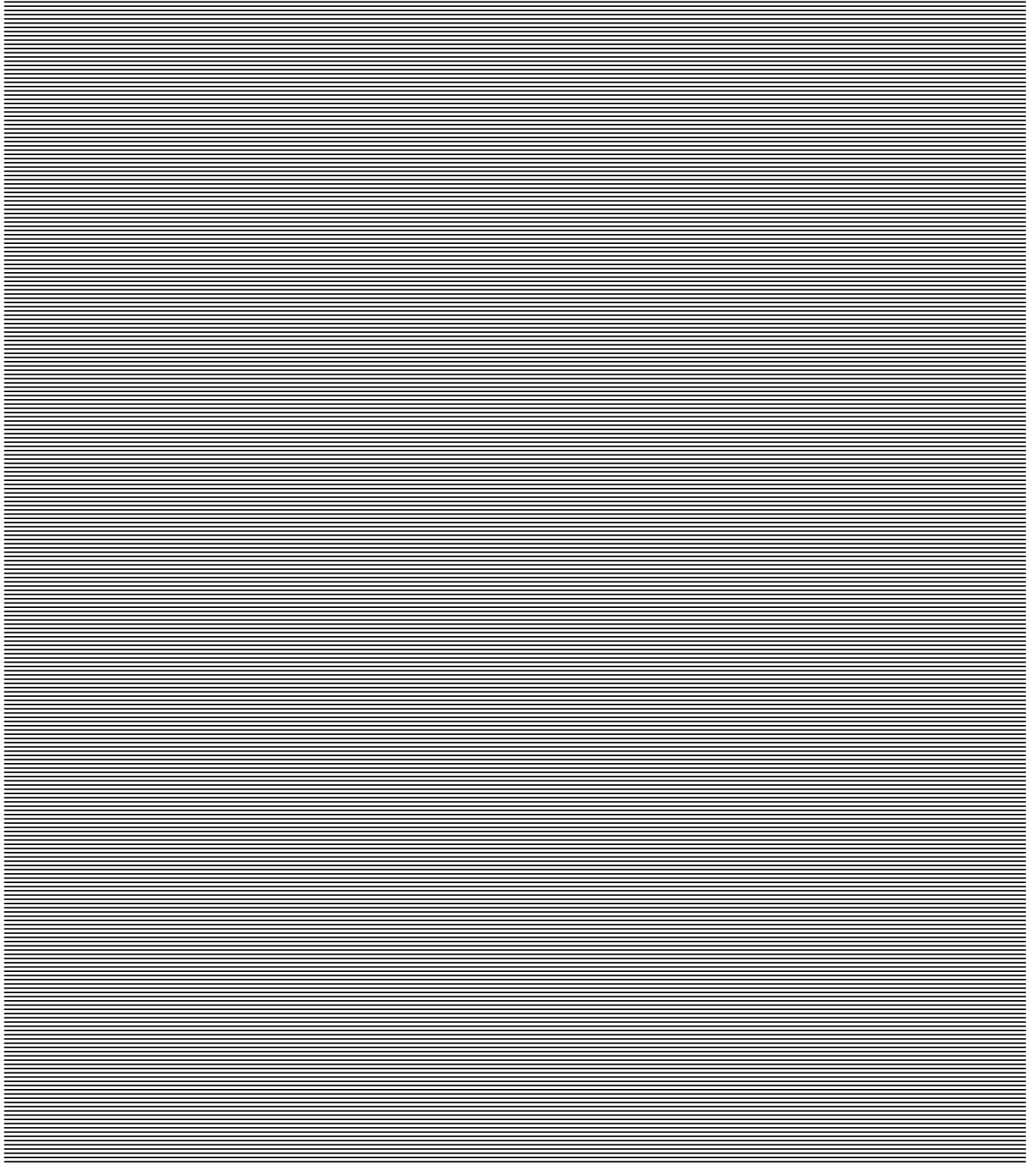

Figure **grating3** from the Moiré Demonstration Kit
accompanying the book: *The Theory of the Moiré Phenomenon*
by I. Amidror, published by Kluwer Academic Publishers, 1999.

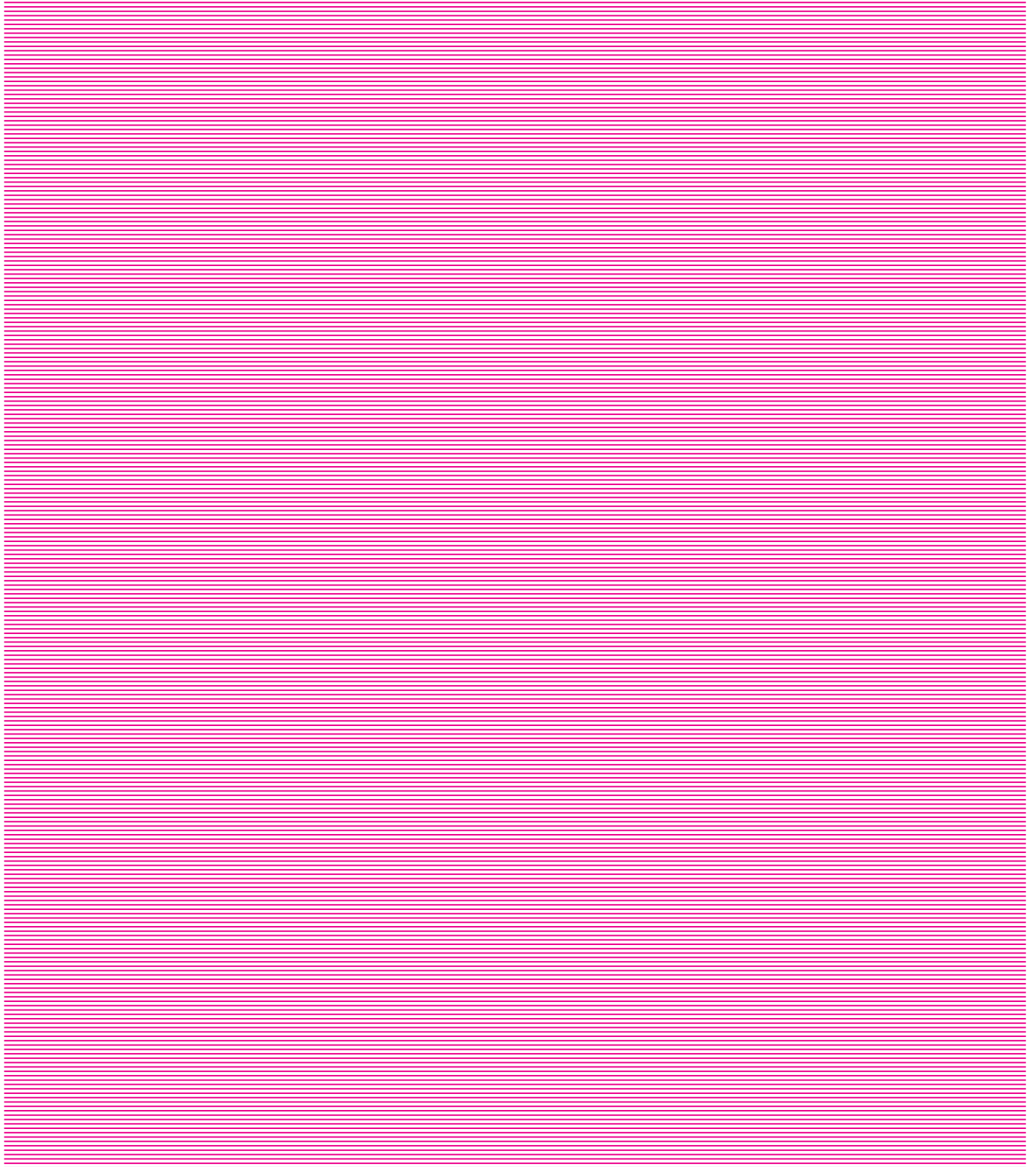

Figure **gratm** from the Moiré Demonstration Kit
accompanying the book: *The Theory of the Moiré Phenomenon*
by I. Amidror, published by Kluwer Academic Publishers, 1999.

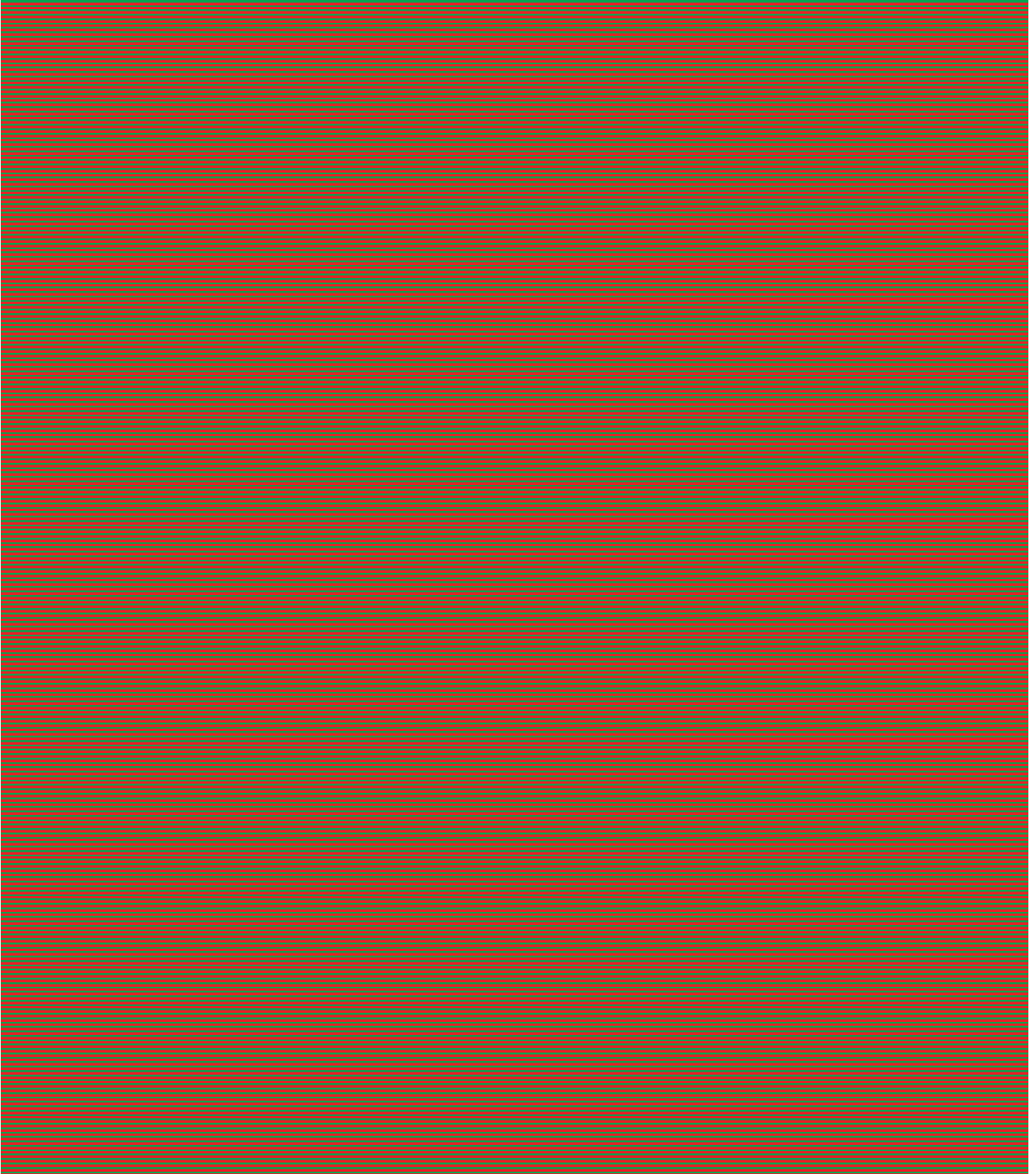

Figure **gratrg** from the Moiré Demonstration Kit
accompanying the book: *The Theory of the Moiré Phenomenon*
by I. Amidror, published by Kluwer Academic Publishers, 1999.

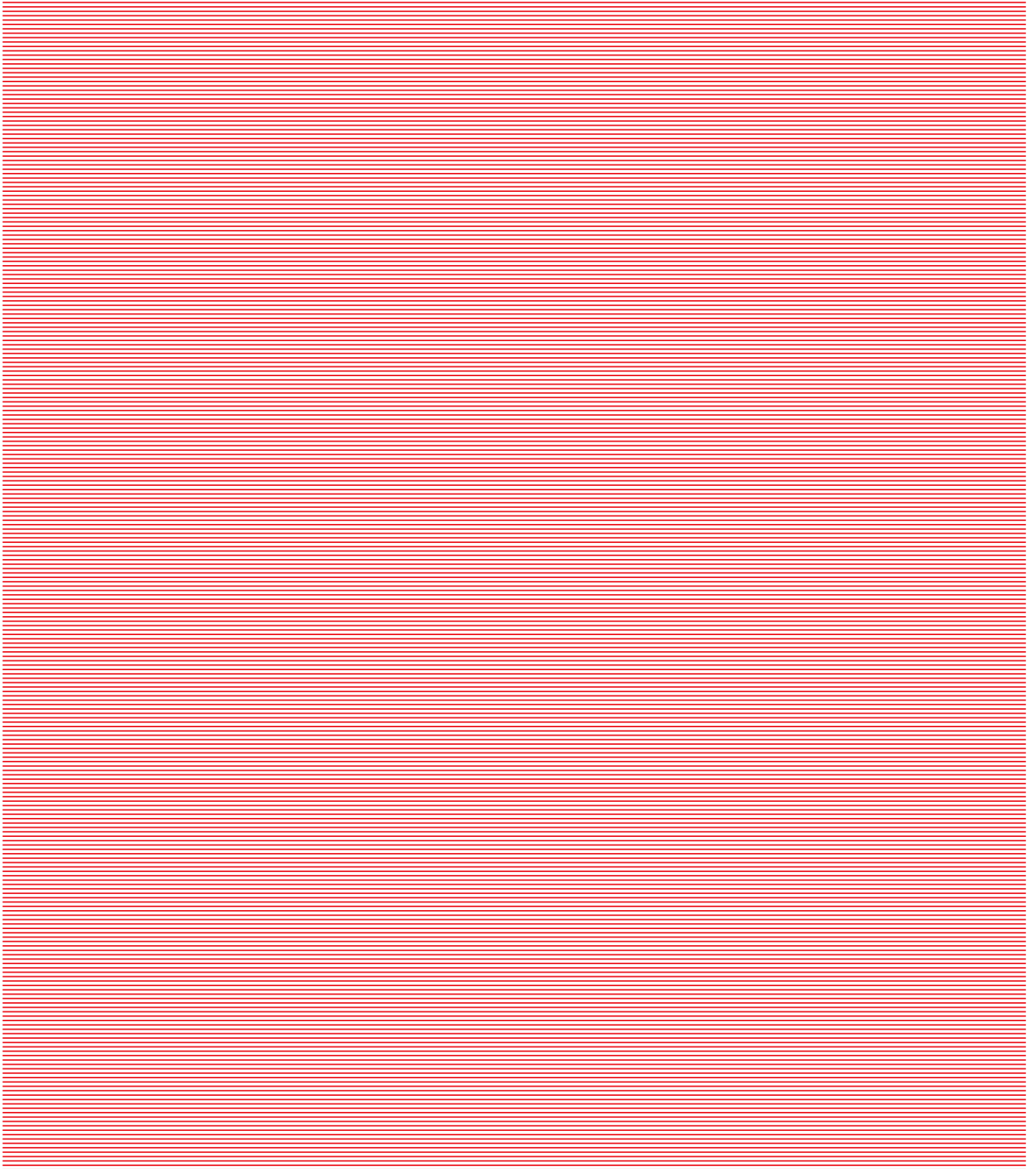

Figure **gratr** from the Moiré Demonstration Kit
accompanying the book: *The Theory of the Moiré Phenomenon*
by I. Amidror, published by Kluwer Academic Publishers, 1999.

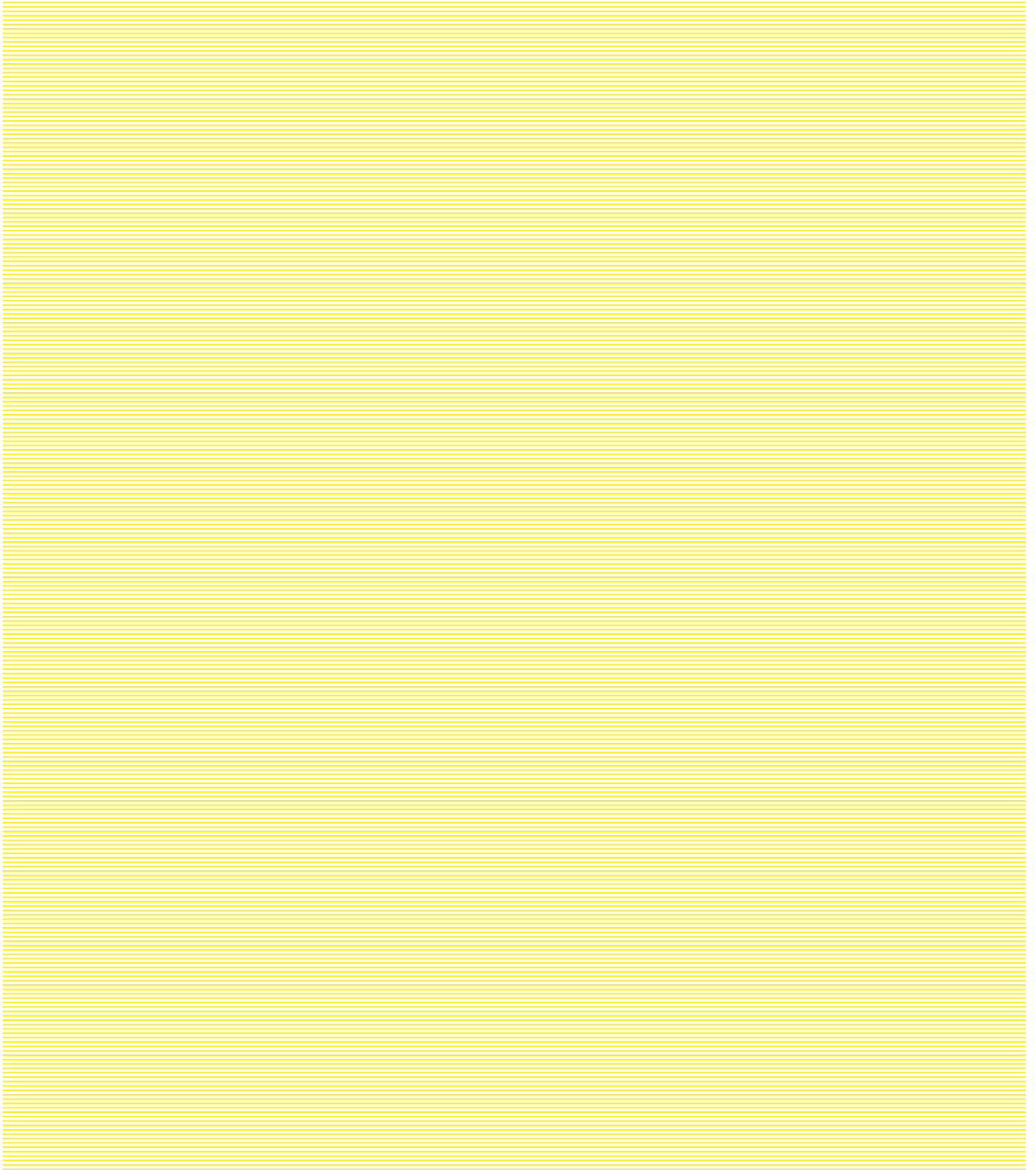

Figure **graty** from the Moiré Demonstration Kit
accompanying the book: *The Theory of the Moiré Phenomenon*
by I. Amidror, published by Kluwer Academic Publishers, 1999.

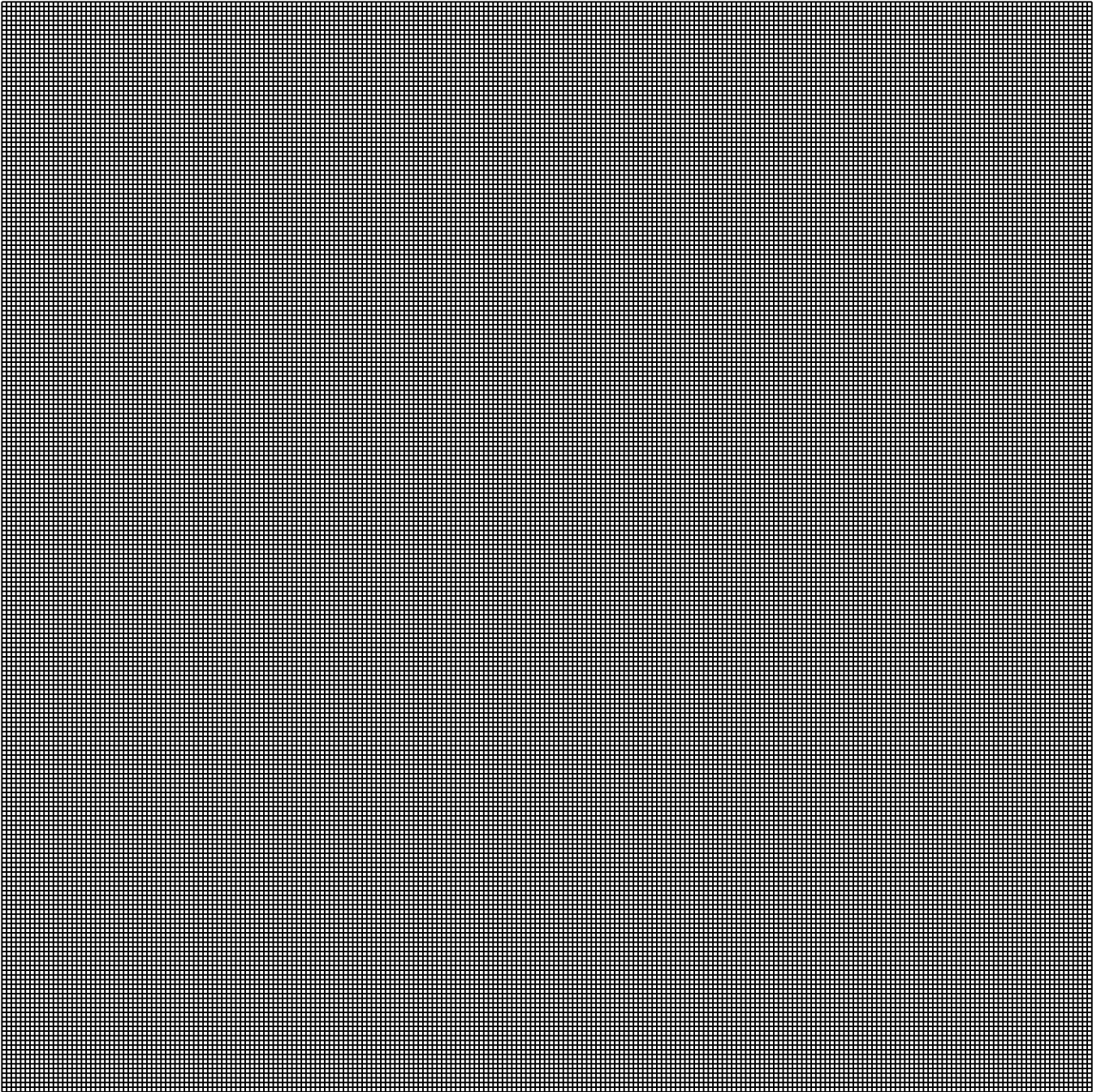

Figure **grid1** from the Moiré Demonstration Kit
accompanying the book: *The Theory of the Moiré Phenomenon*
by I. Amidror, published by Kluwer Academic Publishers, 1999.

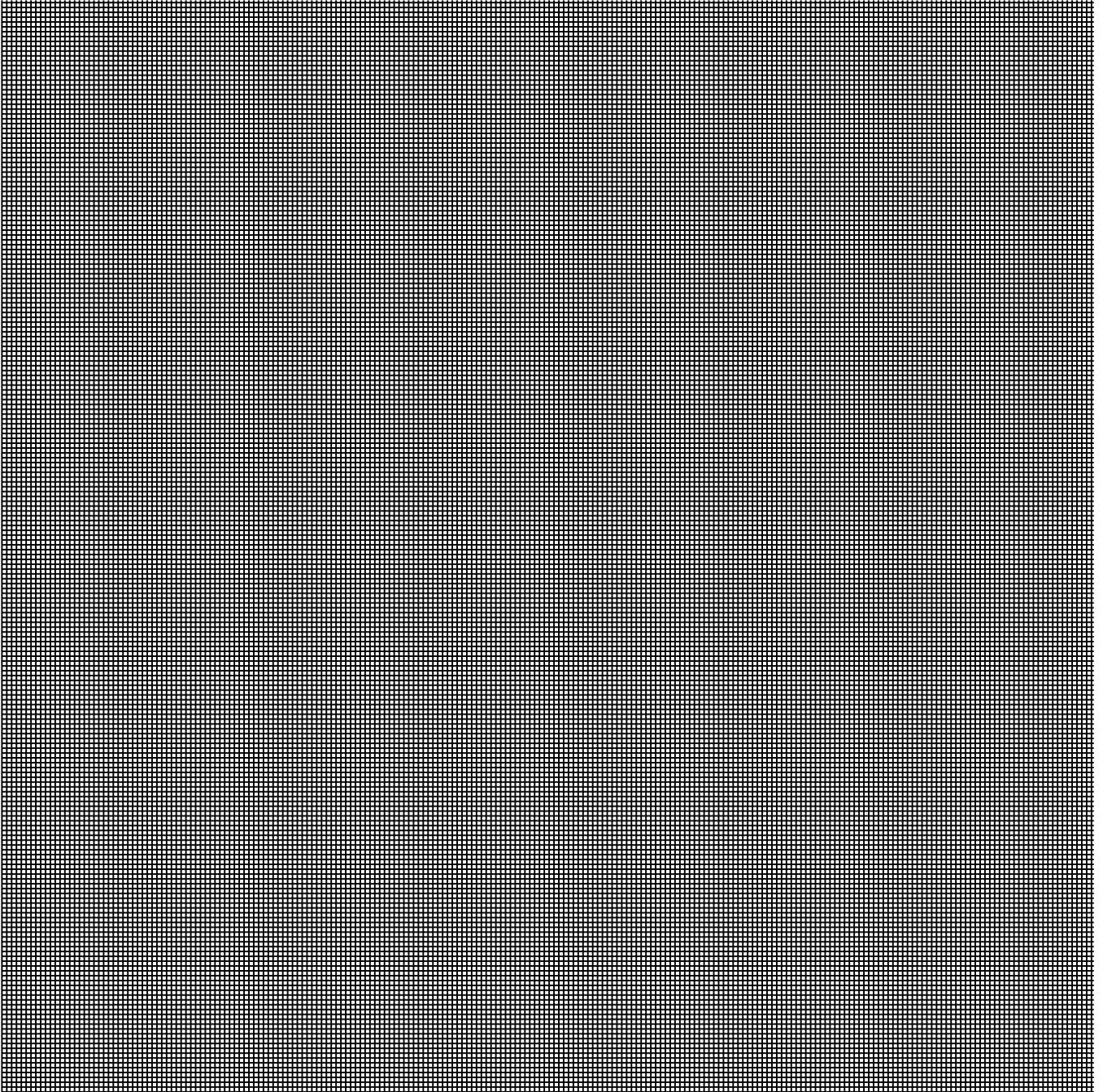

Figure **grid2** from the Moiré Demonstration Kit
accompanying the book: *The Theory of the Moiré Phenomenon*
by I. Amidror, published by Kluwer Academic Publishers, 1999.

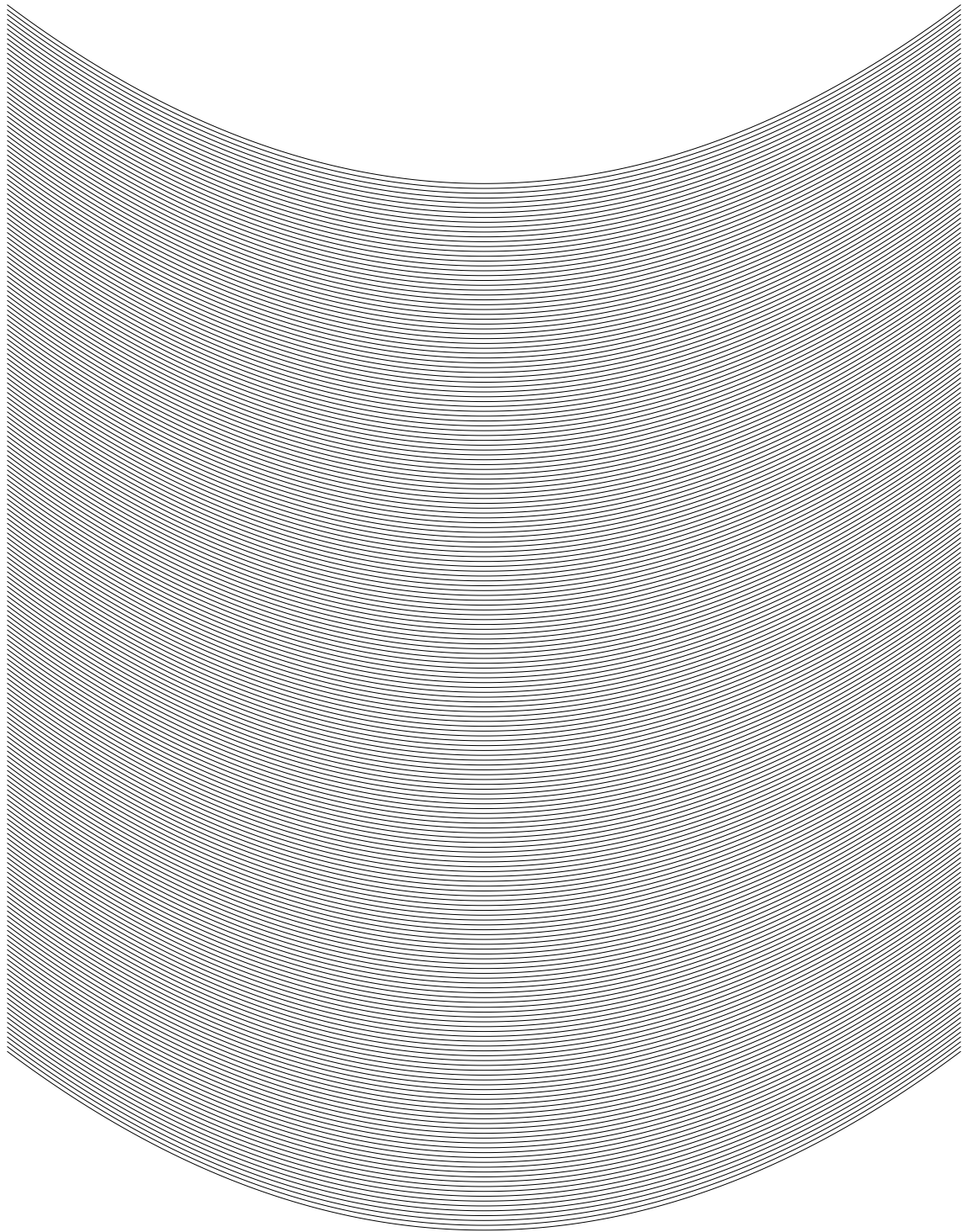

Figure **parabol1** from the Moiré Demonstration Kit
accompanying the book: *The Theory of the Moiré Phenomenon*
by I. Amidror, published by Kluwer Academic Publishers, 1999.

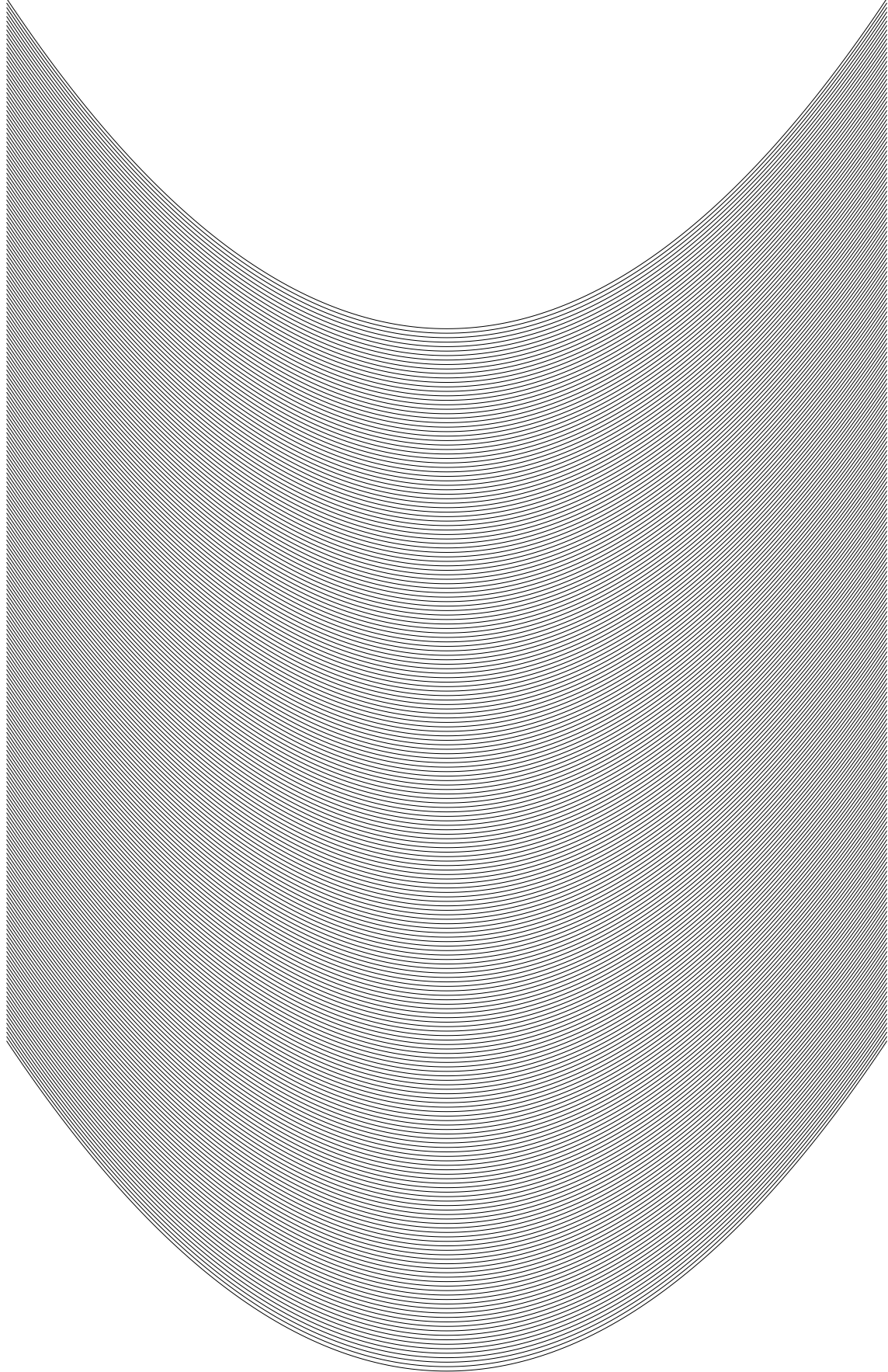

Figure **parabol2** from the Moiré Demonstration Kit
accompanying the book: *The Theory of the Moiré Phenomenon*
by I. Amidror, published by Kluwer Academic Publishers, 1999.

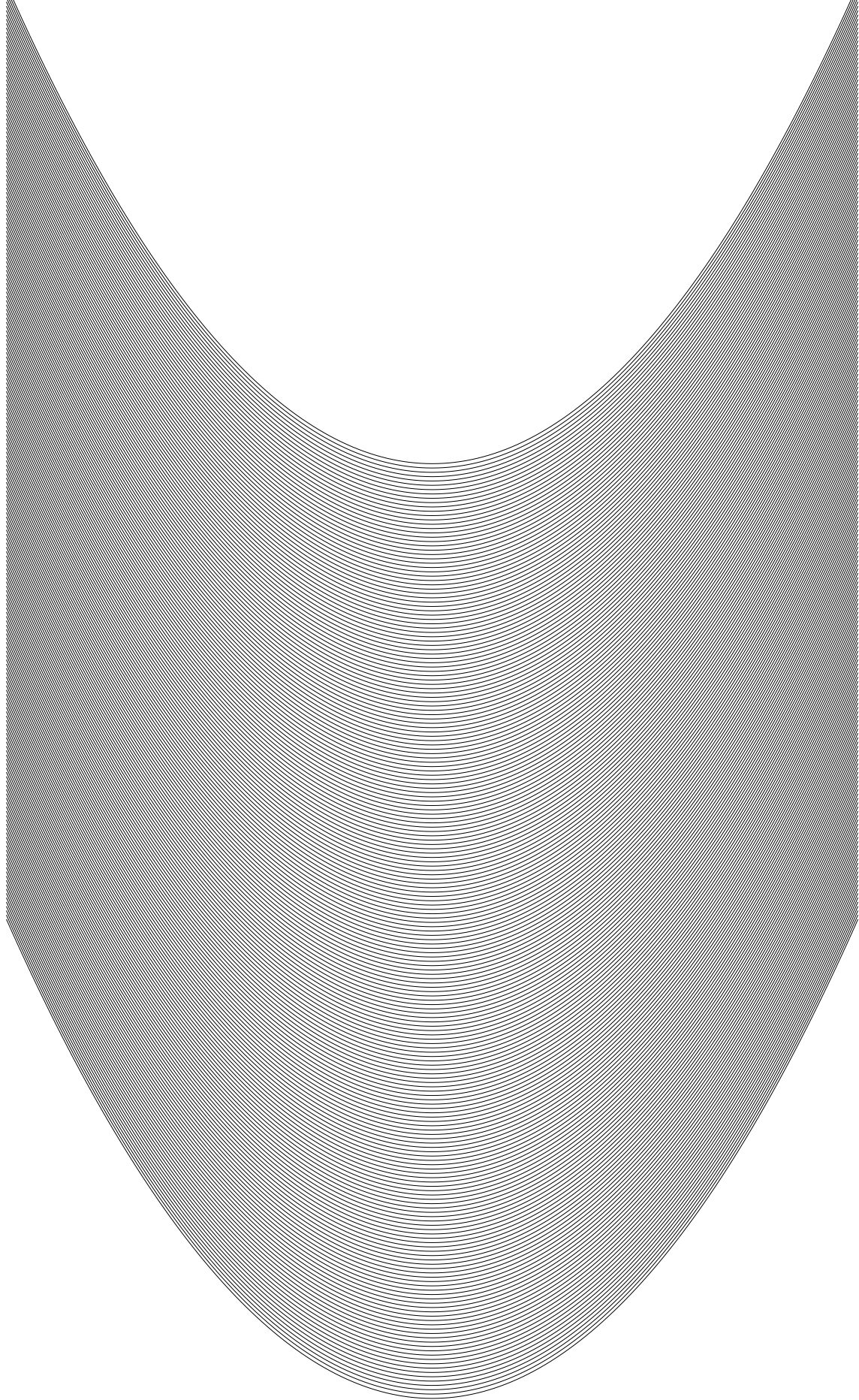

Figure **parabol3** from the Moiré Demonstration Kit
accompanying the book: *The Theory of the Moiré Phenomenon*
by I. Amidror, published by Kluwer Academic Publishers, 1999.

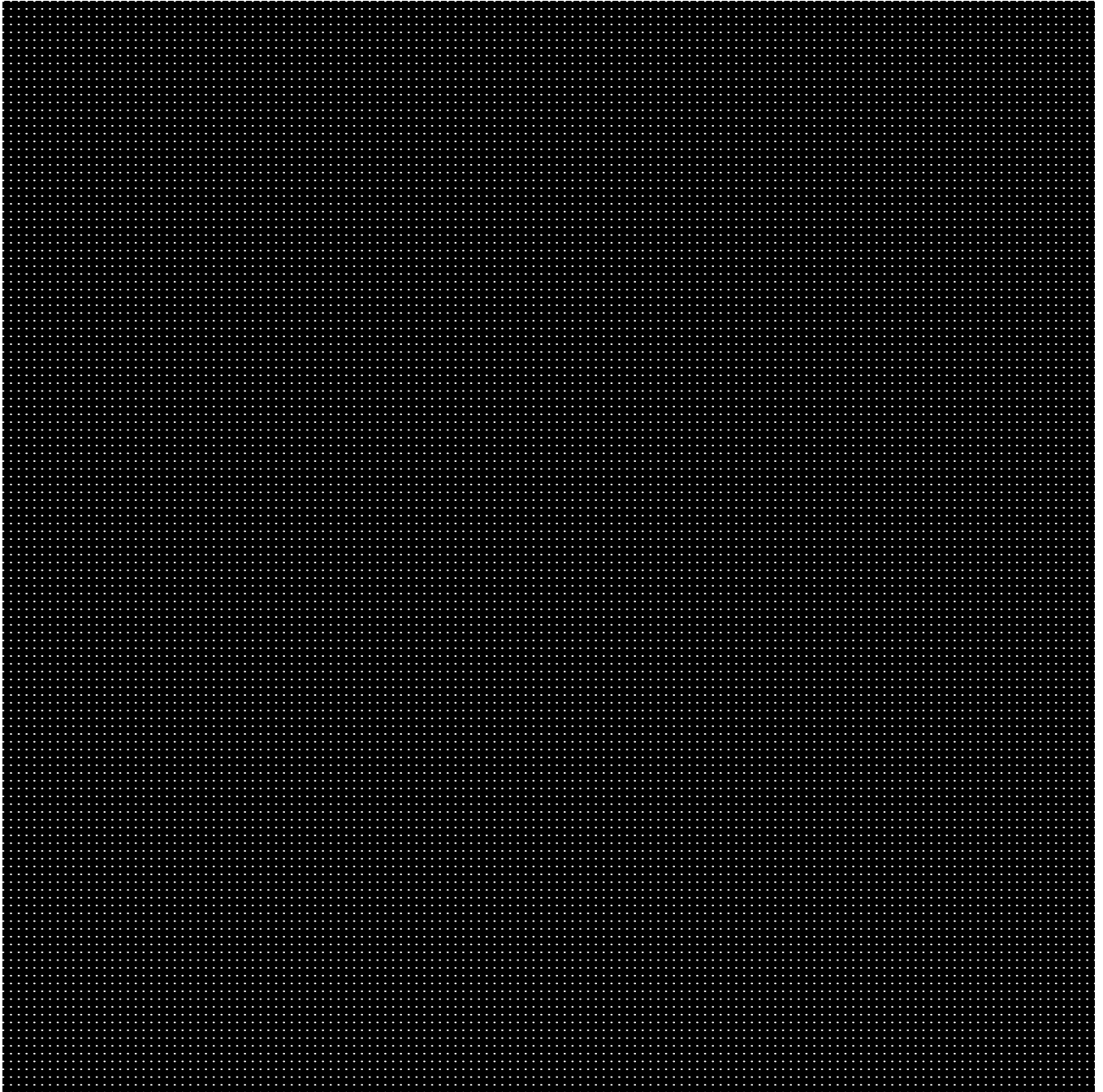

Figure **perhole** from the Moiré Demonstration Kit
Accompanying the book: *The Theory of the Moiré Phenomenon*
by I. Amidror, published by Kluwer Academic Publishers, 2000.

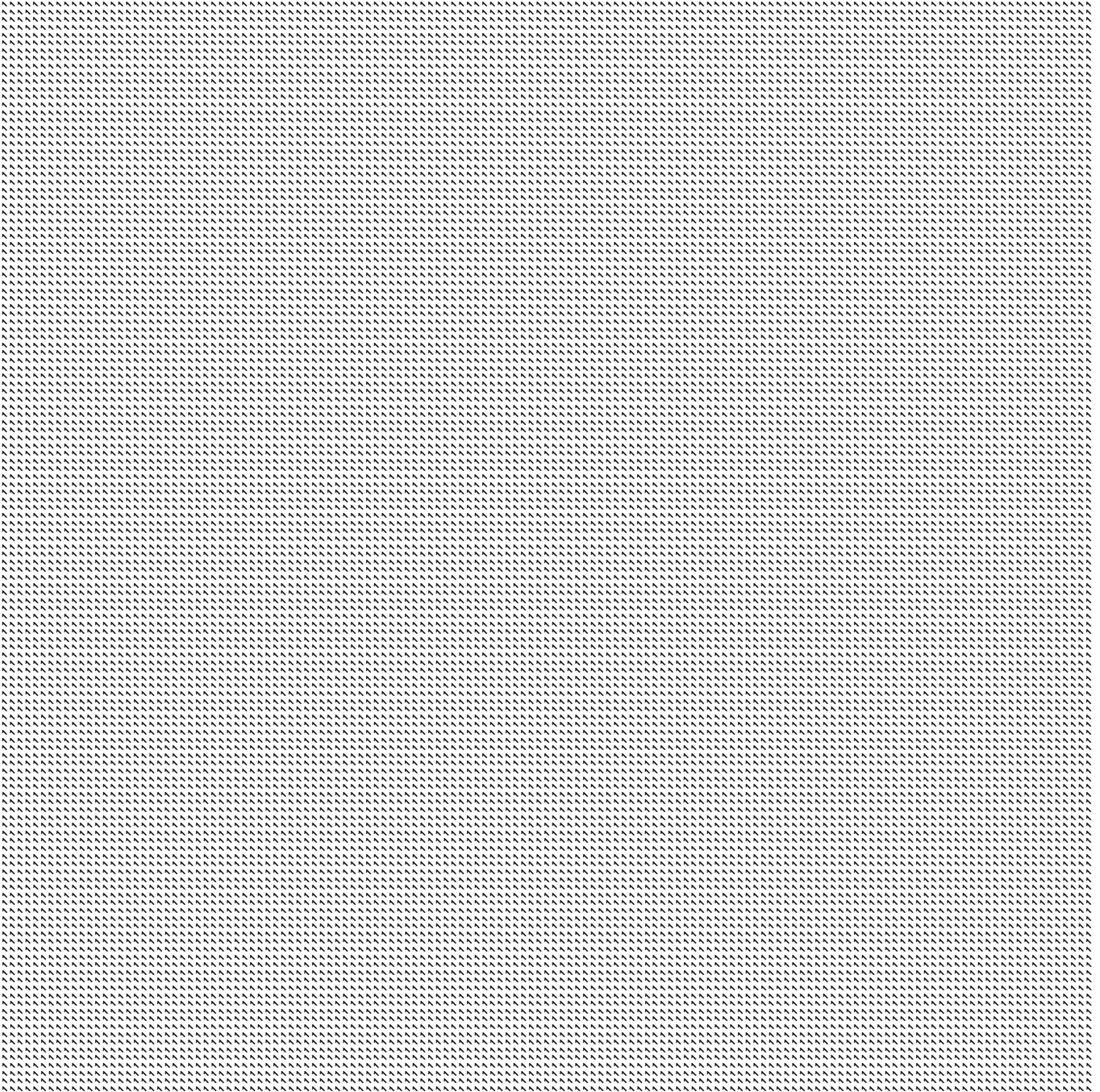

Figure **perone** from the Moiré Demonstration Kit
Accompanying the book: *The Theory of the Moiré Phenomenon*
by I. Amidror, published by Kluwer Academic Publishers, 2000.

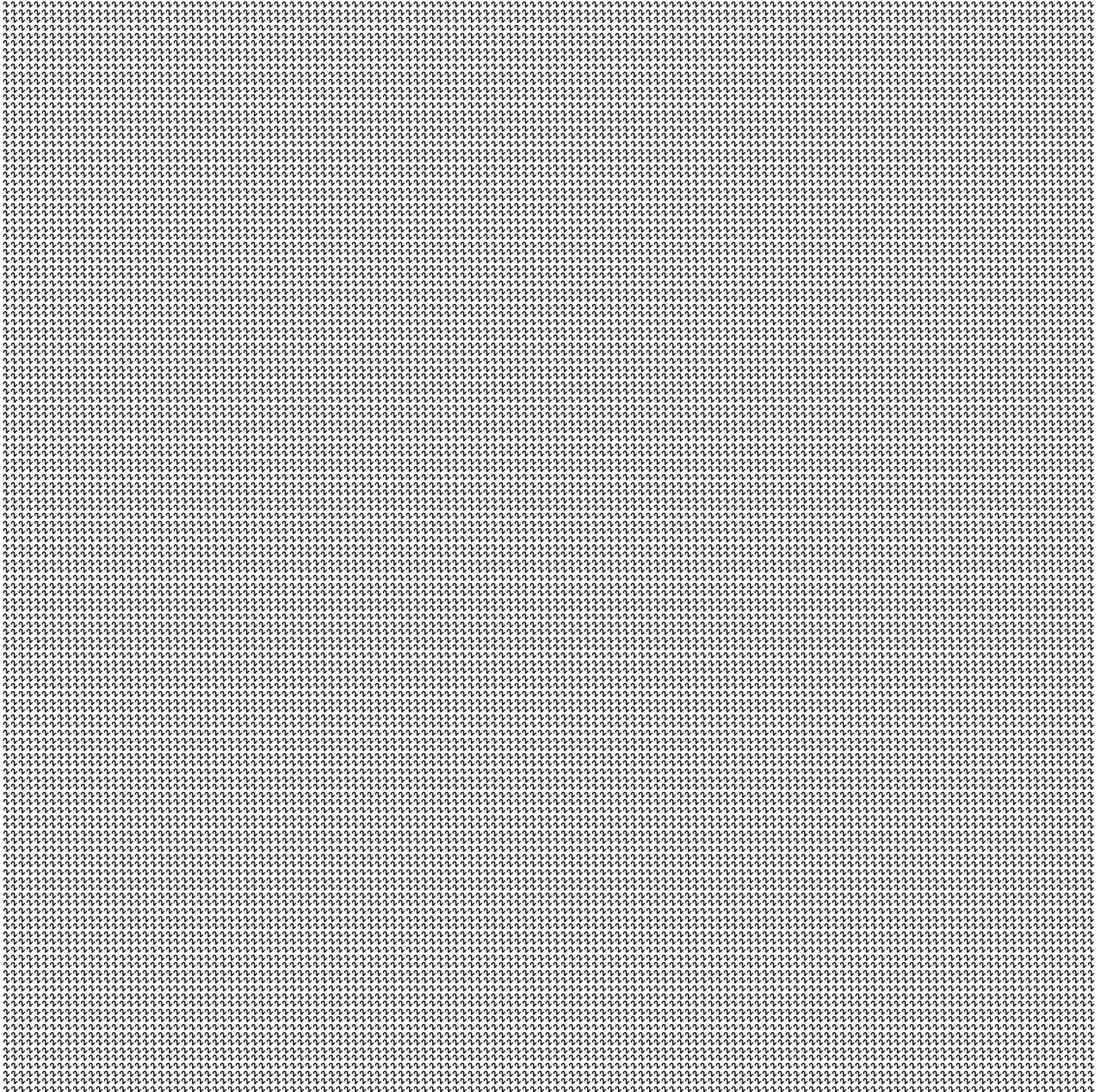
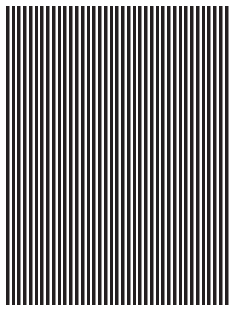
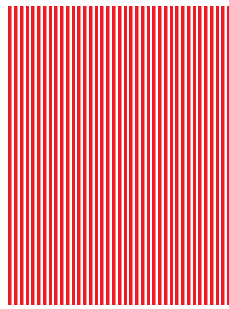

Figure **pertwo** from the Moiré Demonstration Kit
Accompanying the book: *The Theory of the Moiré Phenomenon*
by I. Amidror, published by Kluwer Academic Publishers, 2000.



(a)



(b)

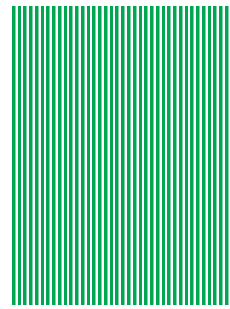

(c)

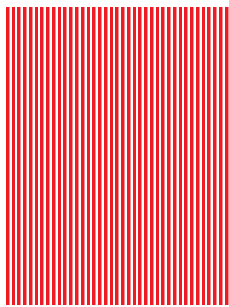

(d)

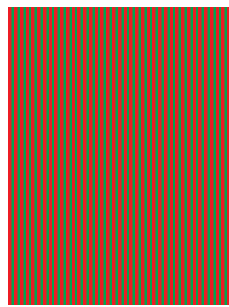

(e)

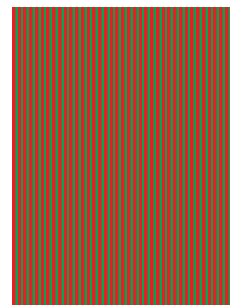

(f)

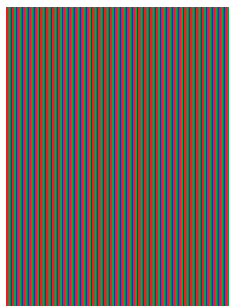

(g)

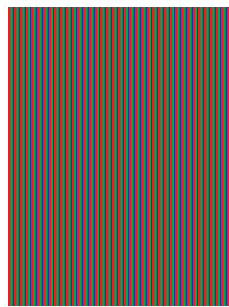

(h)

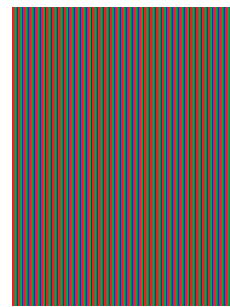

(i)



Colour Plate 2 from the book: *The Theory of the Moiré Phenomenon*
by I. Amidror, published by Kluwer Academic Publishers, 1999.

(First layer only.)

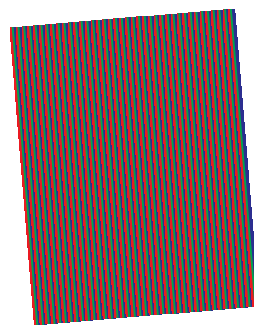
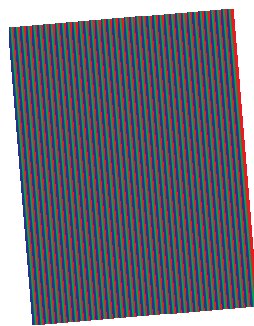
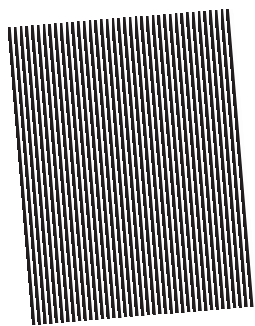
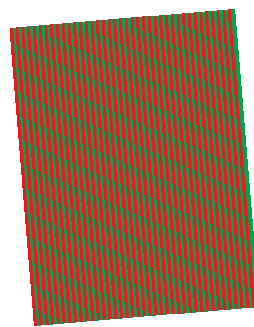
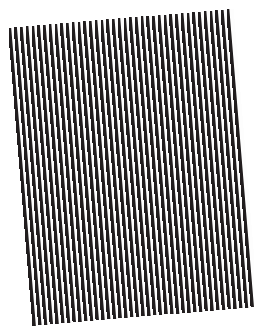
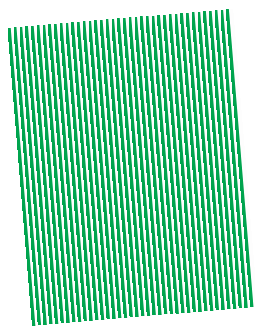
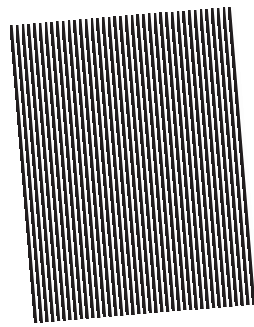
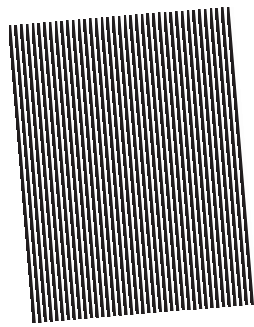
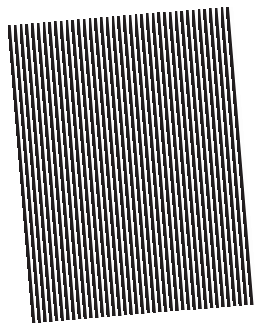

Colour Plate 2 from the book: *The Theory of the Moiré Phenomenon*
by I. Amidror, published by Kluwer Academic Publishers, 1999.

(Second layer only.)

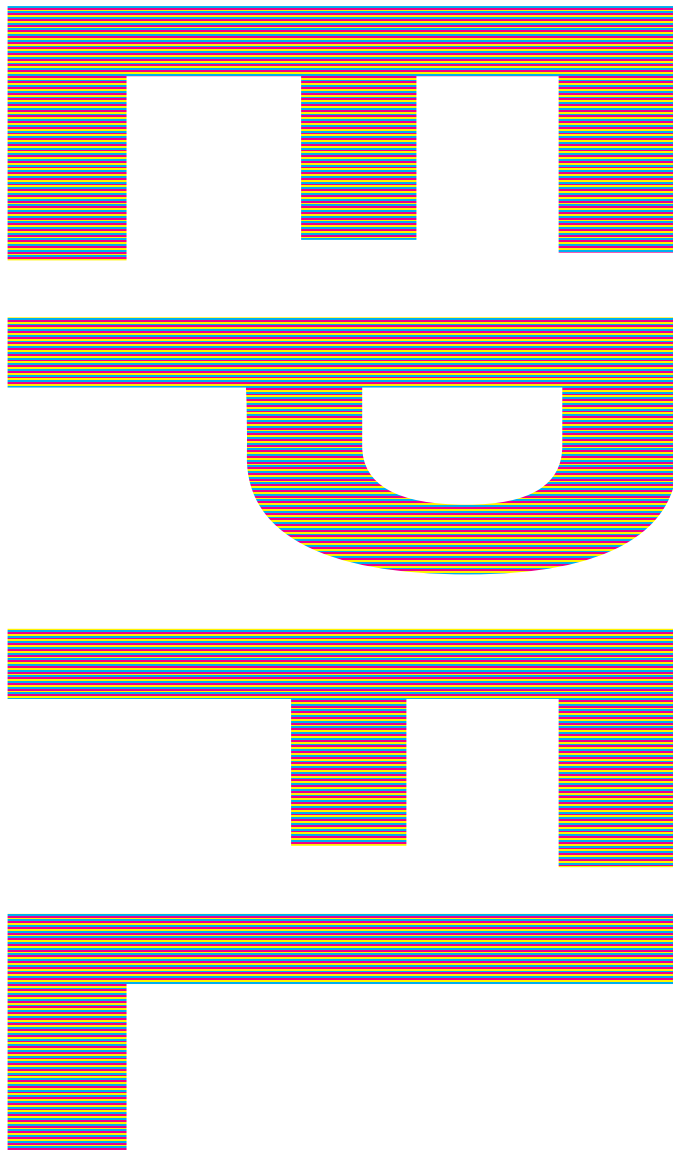

Colour Plate 4 from the book: *The Theory of the Moiré Phenomenon*
by I. Amidror, published by Kluwer Academic Publishers, 1999.

(First layer only.)

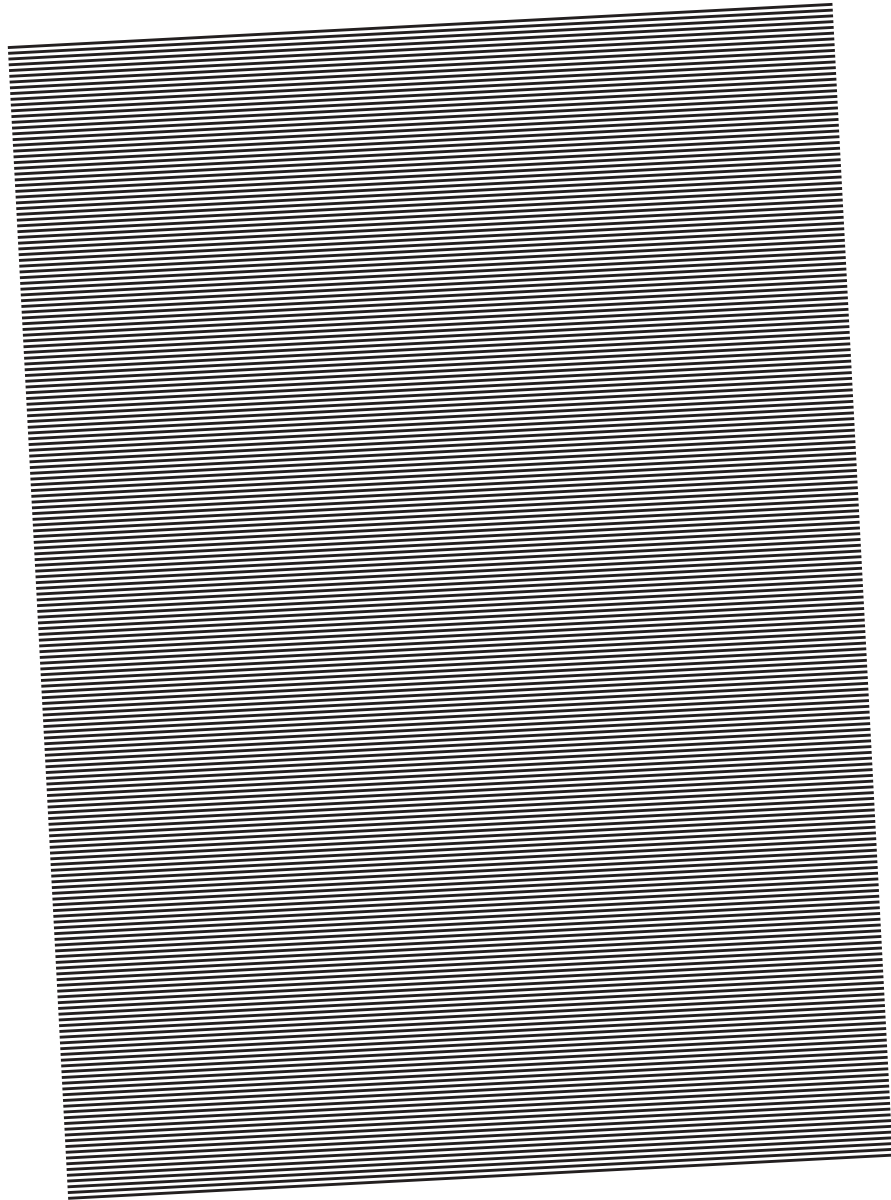

Colour Plate 4 from the book: *The Theory of the Moiré Phenomenon*
by I. Amidror, published by Kluwer Academic Publishers, 1999.

(Second layer only.)

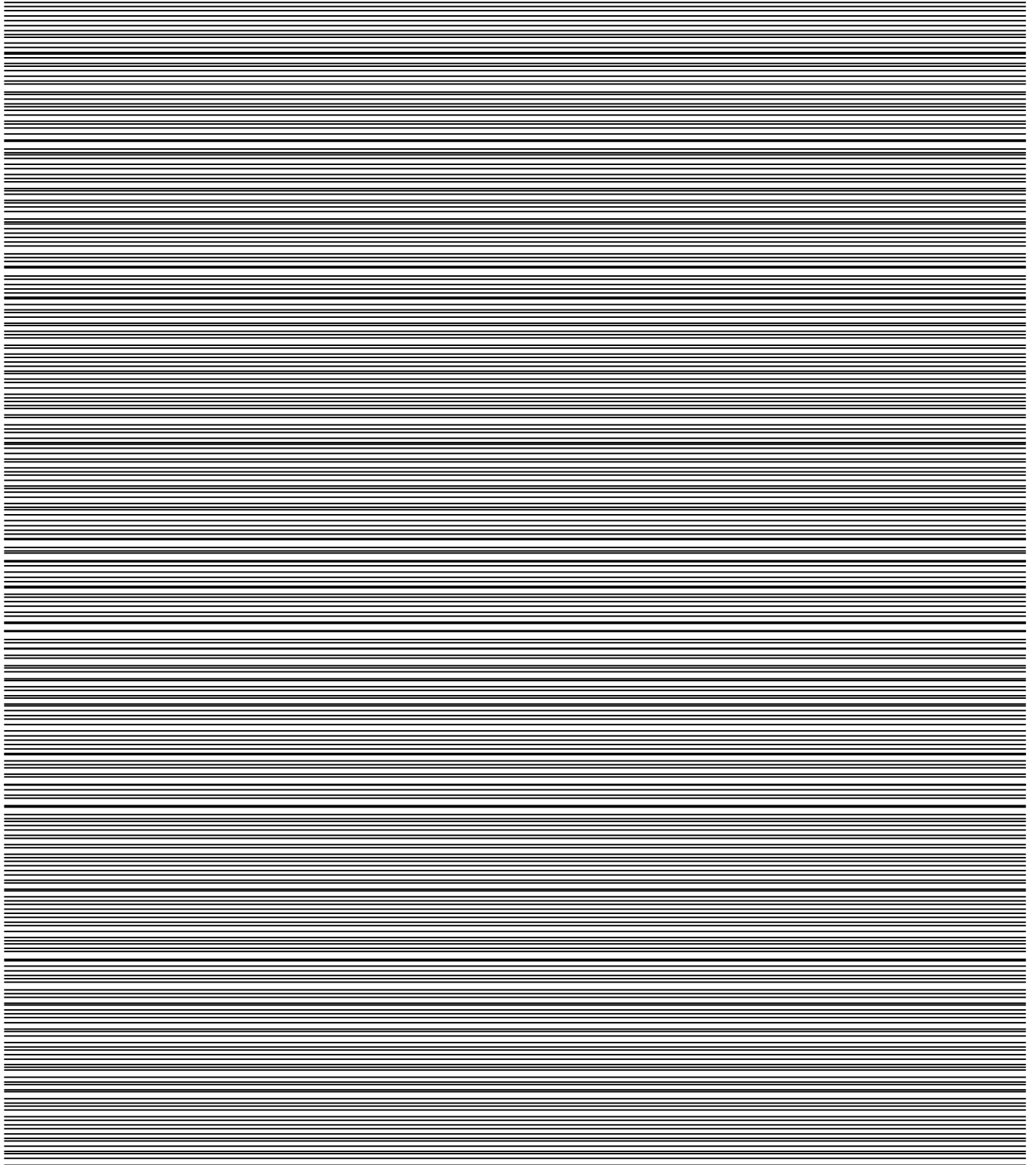

Figure **randgrt1** from the Moiré Demonstration Kit
accompanying the book: *The Theory of the Moiré Phenomenon*
by I. Amidror, published by Kluwer Academic Publishers, 2000.

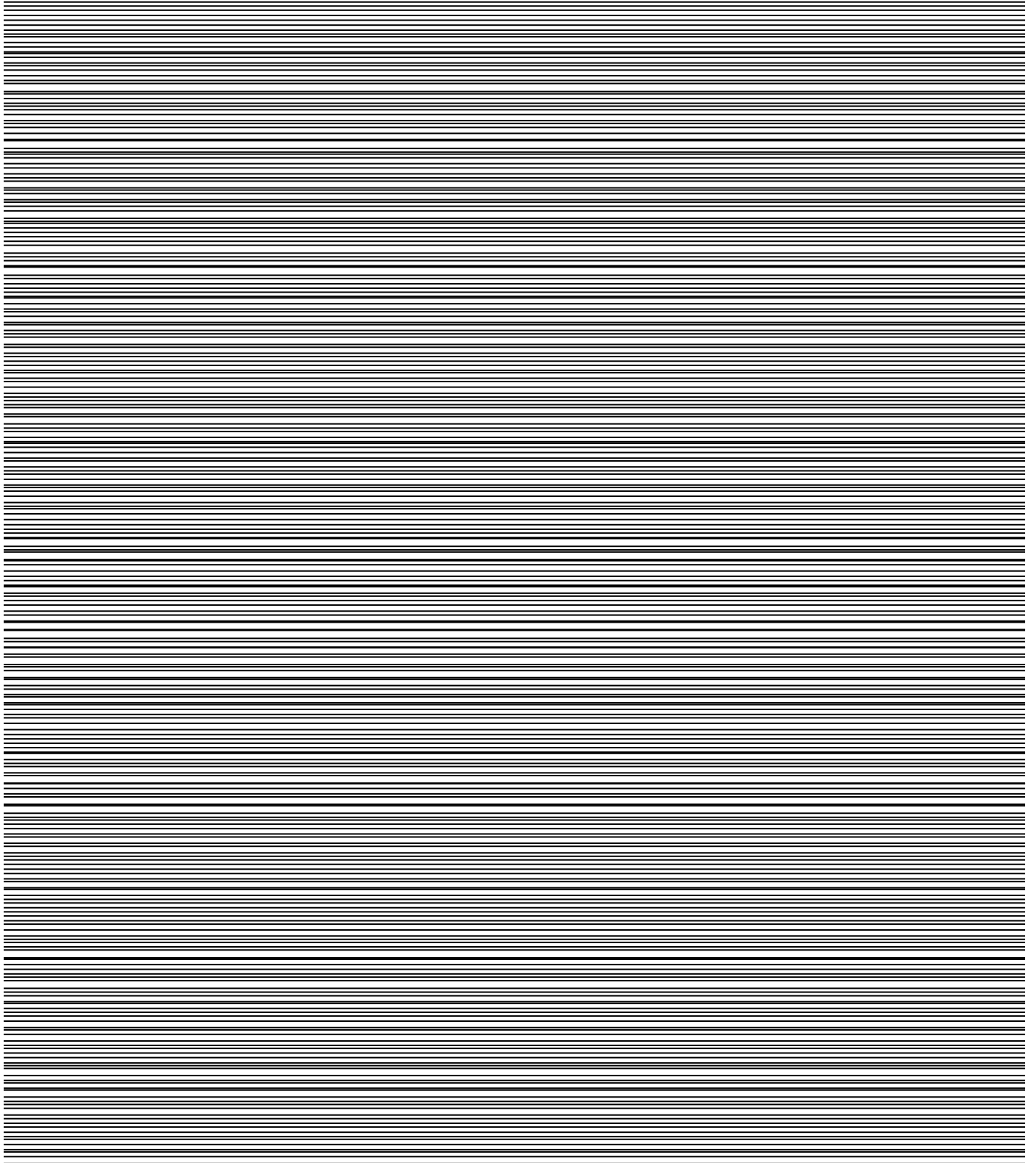

Figure **randgrt2** from the Moiré Demonstration Kit
accompanying the book: *The Theory of the Moiré Phenomenon*
by I. Amidror, published by Kluwer Academic Publishers, 2000.

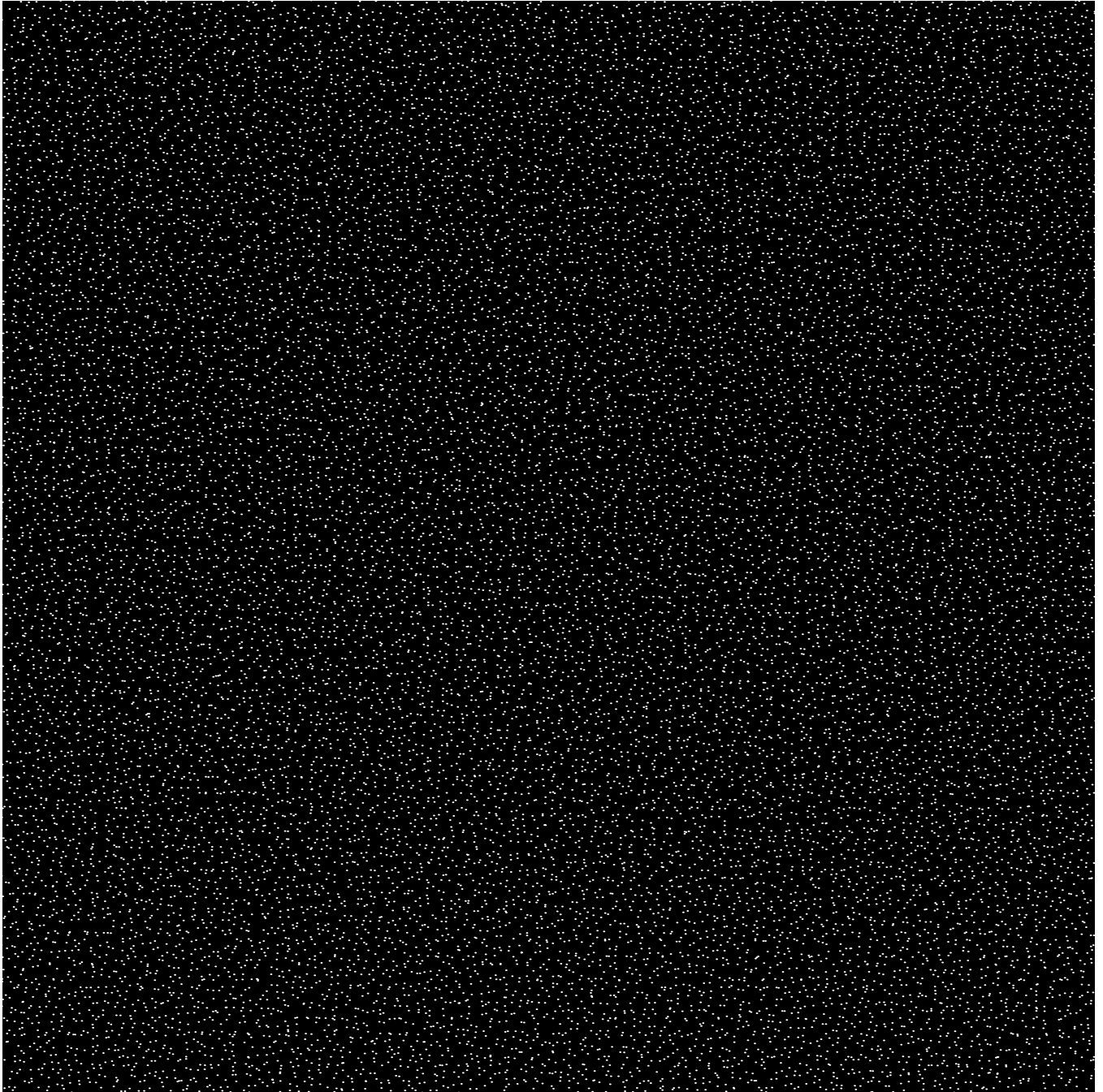

Figure **randhole** from the Moiré Demonstration Kit
Accompanying the book: *The Theory of the Moiré Phenomenon*
by I. Amidror, published by Kluwer Academic Publishers, 2000.

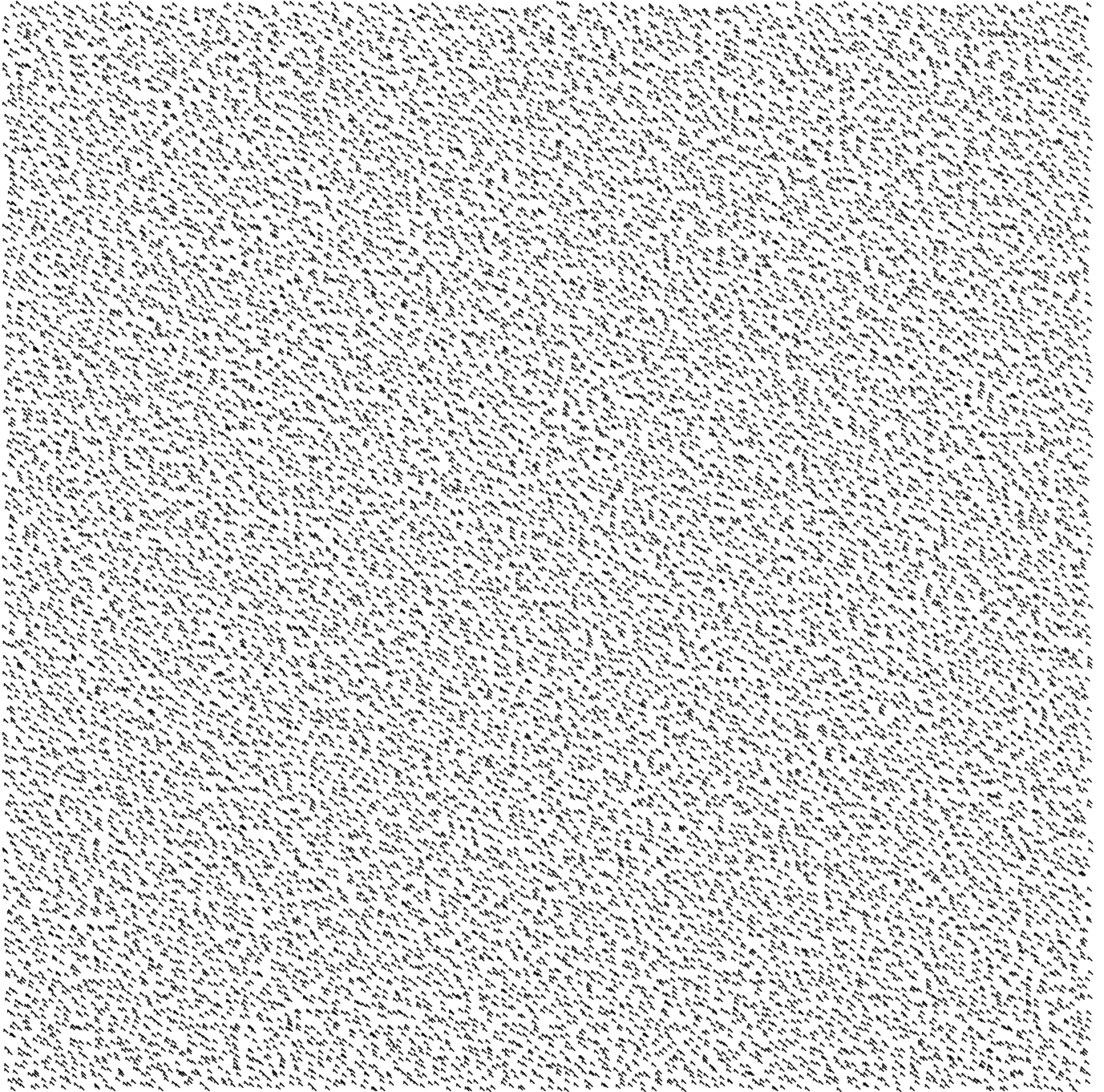

Figure **randone** from the Moiré Demonstration Kit
Accompanying the book: *The Theory of the Moiré Phenomenon*
by I. Amidror, published by Kluwer Academic Publishers, 2000.

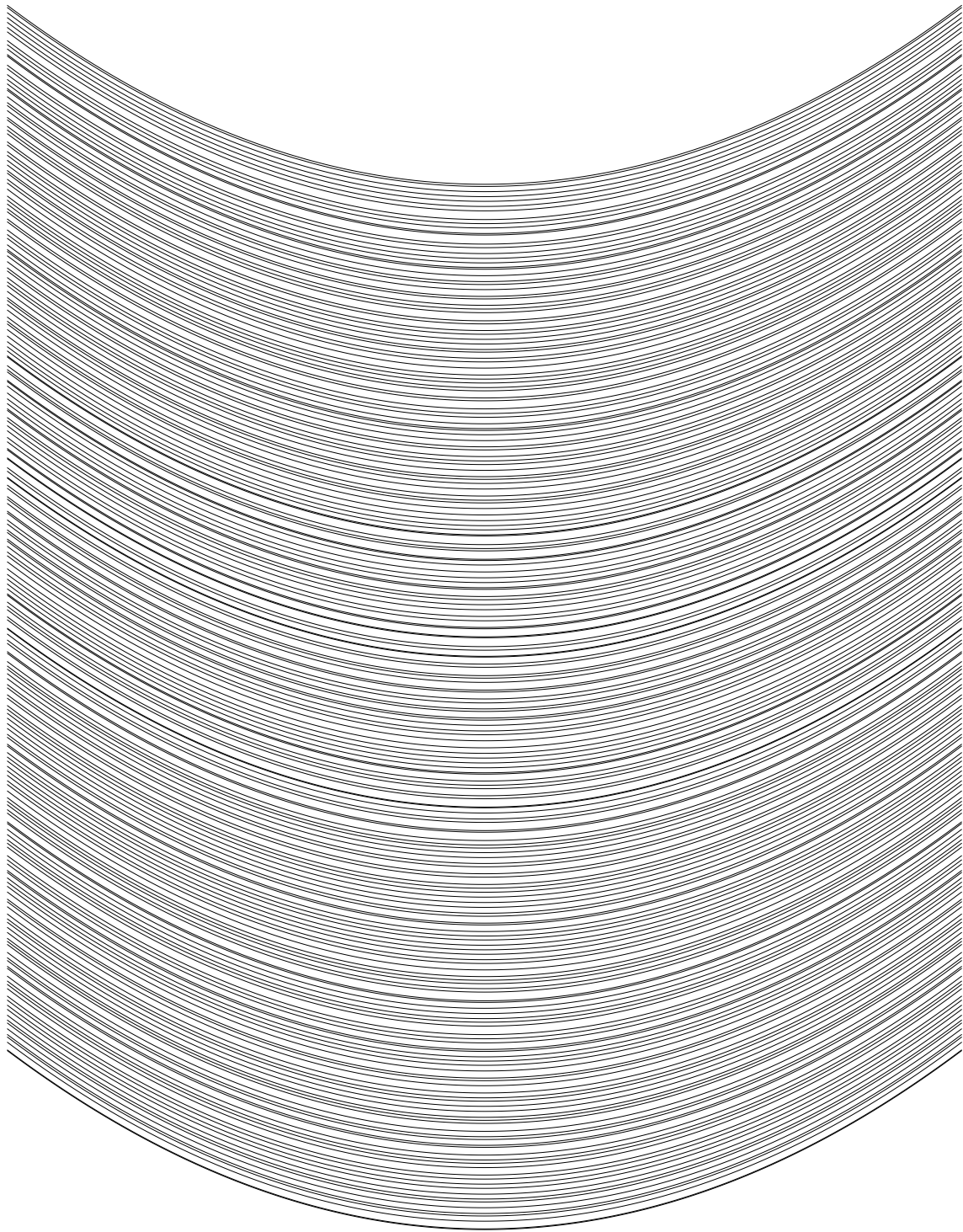

Figure **randpar1** from the Moiré Demonstration Kit
accompanying the book: *The Theory of the Moiré Phenomenon*
by I. Amidror, published by Kluwer Academic Publishers, 2000.

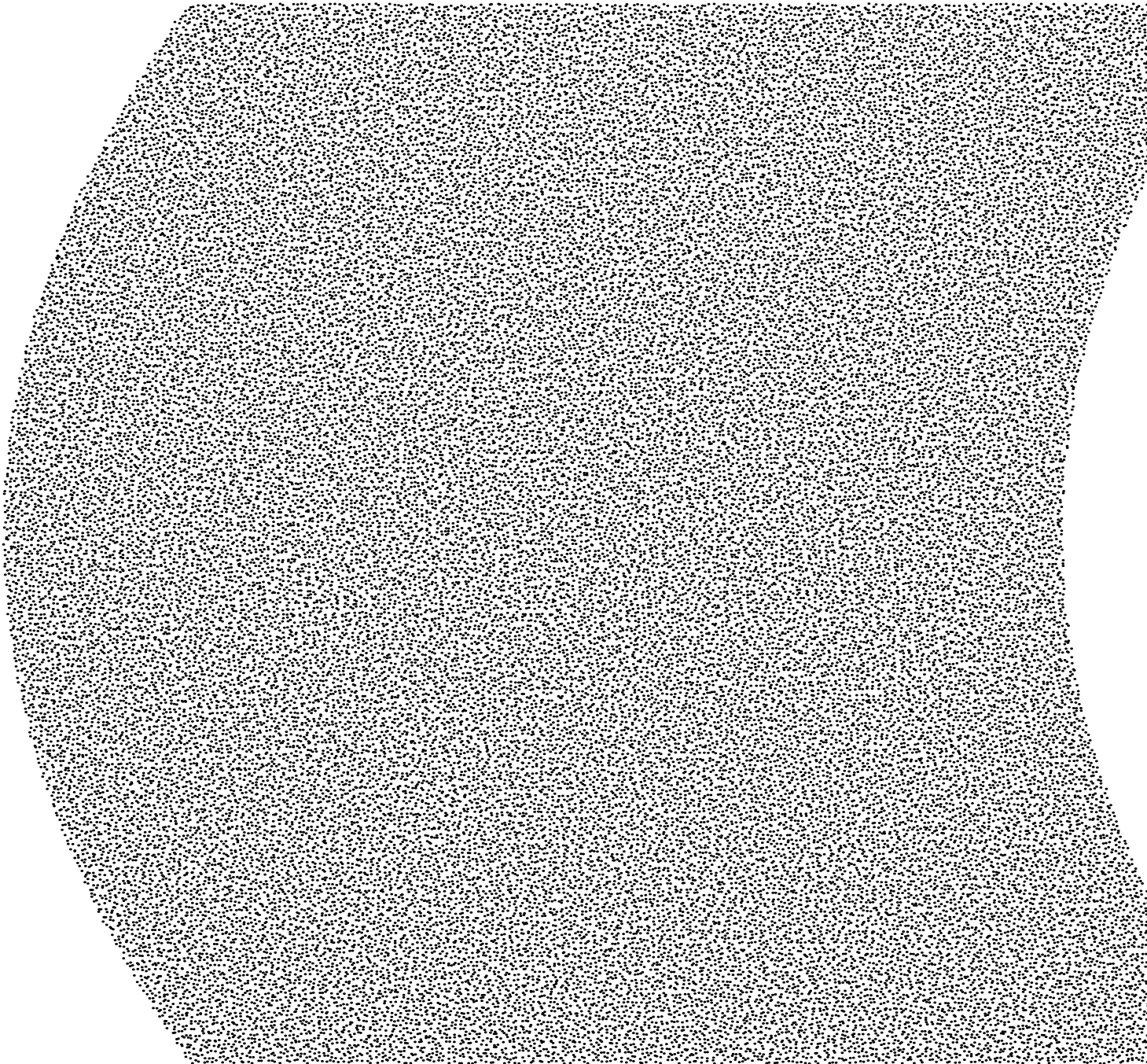

Figure **randparh** from the Moiré Demonstration Kit
accompanying the book: *The Theory of the Moiré Phenomenon*
by I. Amidror, published by Kluwer Academic Publishers, 2000.

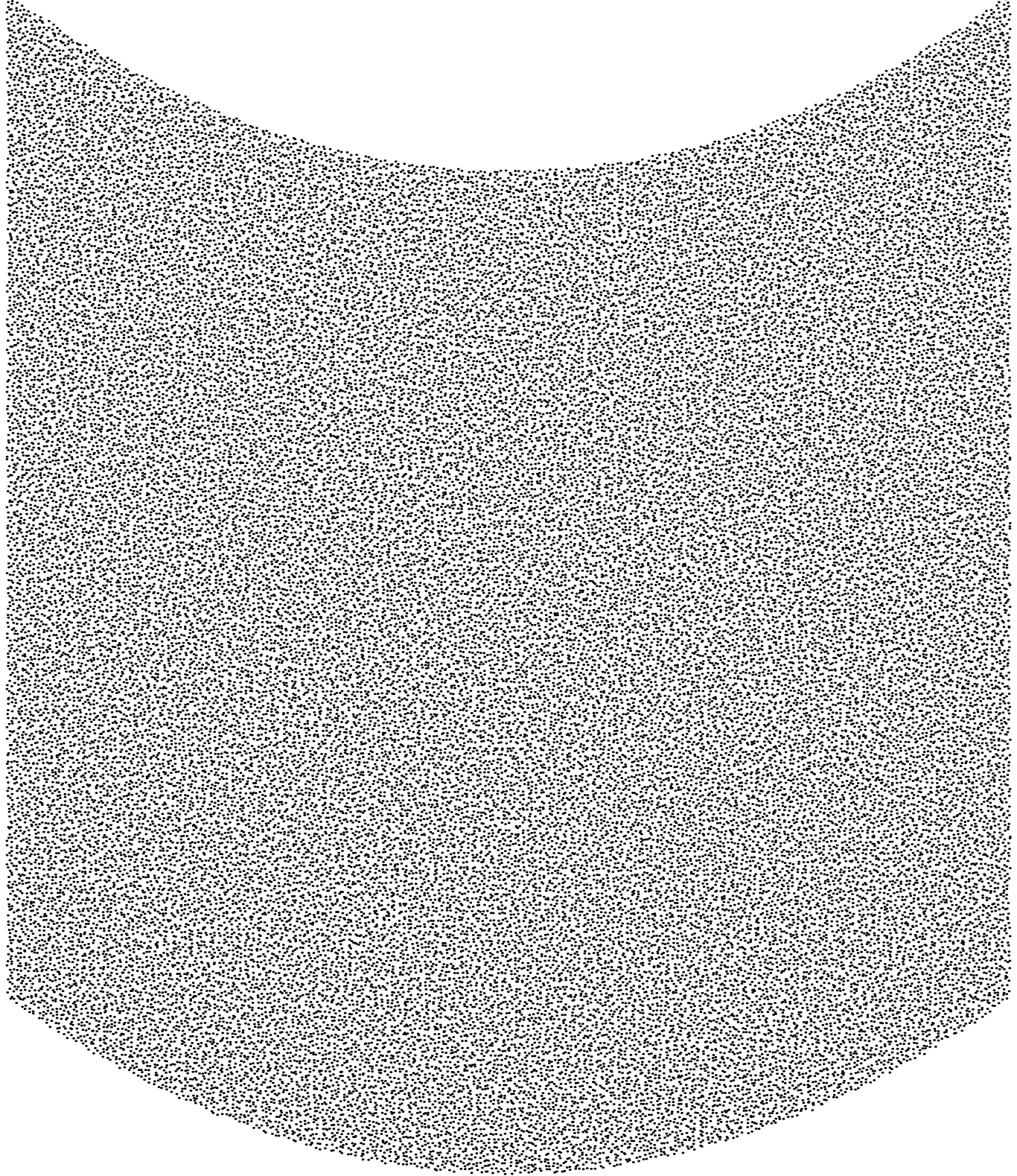

Figure **randparv** from the Moiré Demonstration Kit
accompanying the book: *The Theory of the Moiré Phenomenon*
by I. Amidror, published by Kluwer Academic Publishers, 2000.

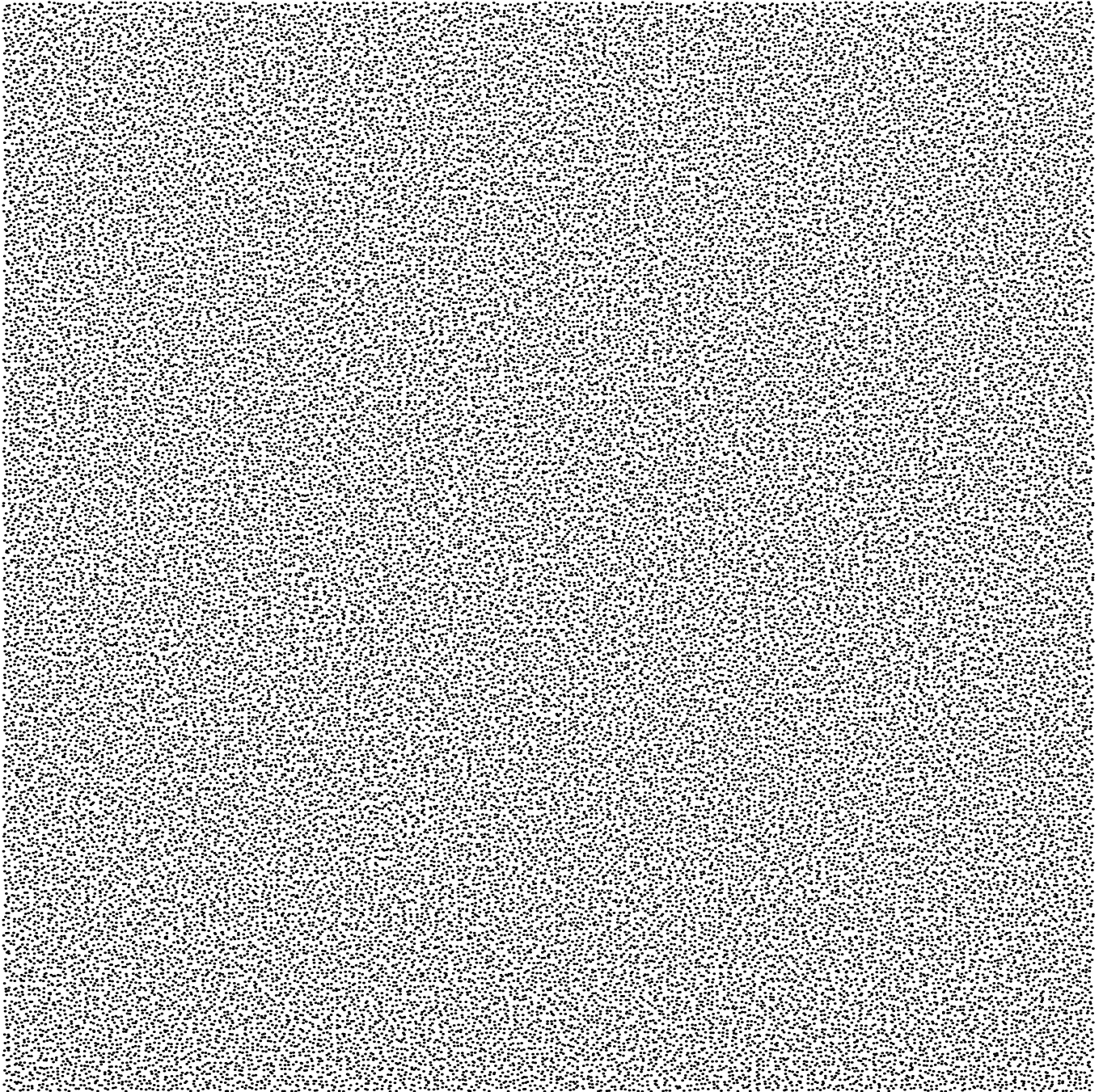

Figure **randscr1** from the Moiré Demonstration Kit
accompanying the book: *The Theory of the Moiré Phenomenon*
by I. Amidror, published by Kluwer Academic Publishers, 2000.

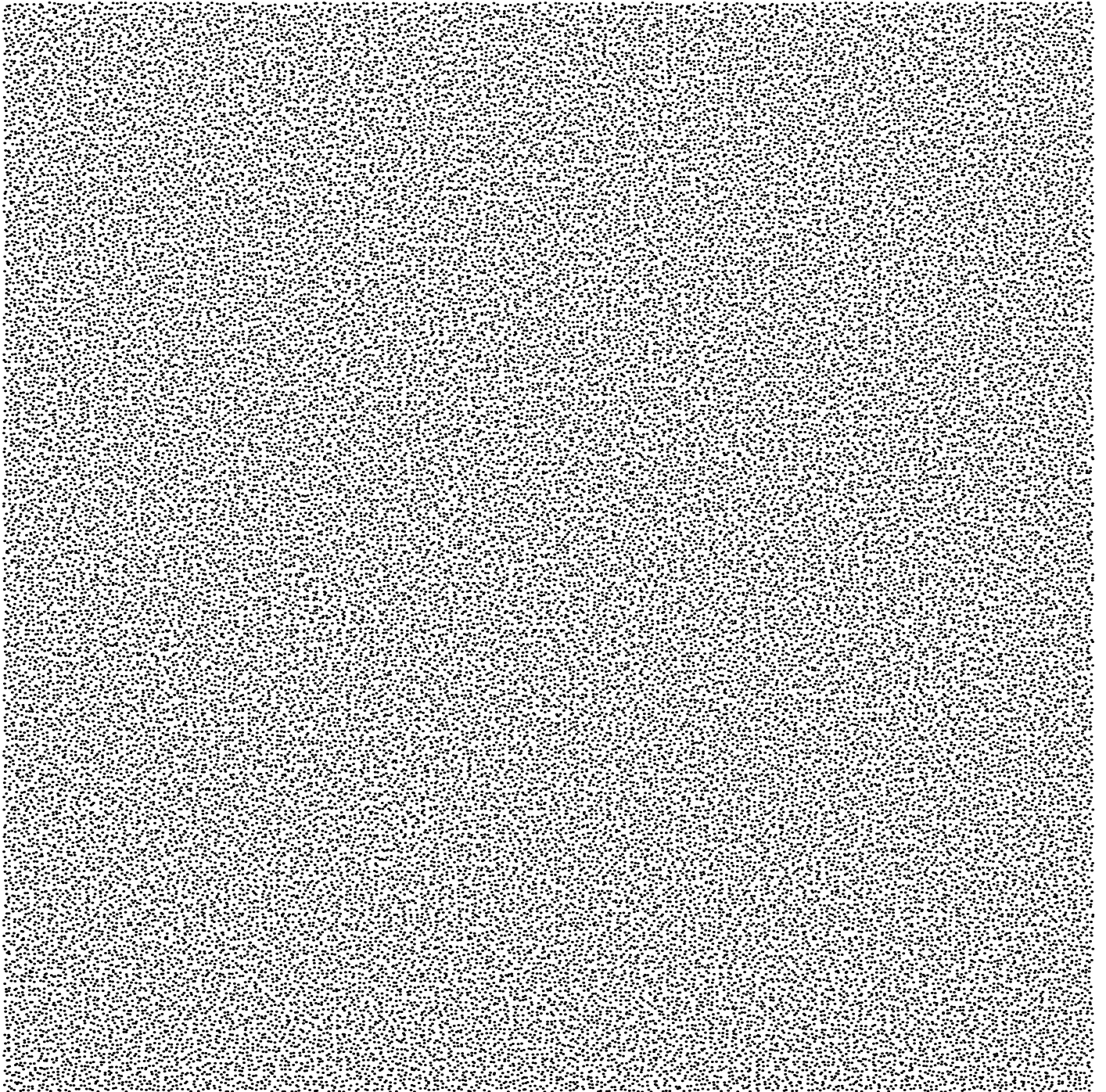

Figure **randscr2** from the Moiré Demonstration Kit
accompanying the book: *The Theory of the Moiré Phenomenon*
by I. Amidror, published by Kluwer Academic Publishers, 2000.

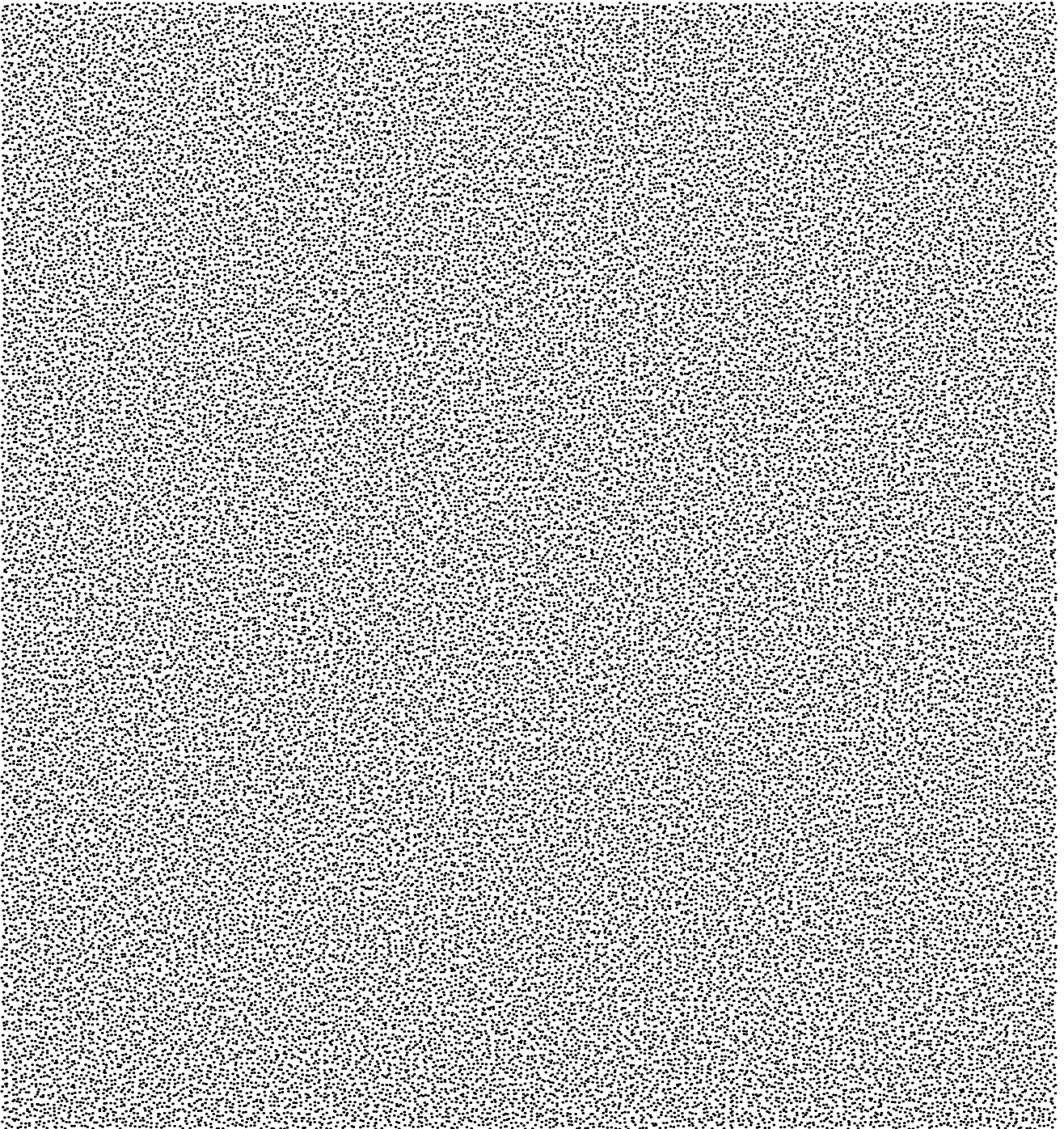

Figure **randscr3** from the Moiré Demonstration Kit
accompanying the book: *The Theory of the Moiré Phenomenon*
by I. Amidror, published by Kluwer Academic Publishers, 2000.

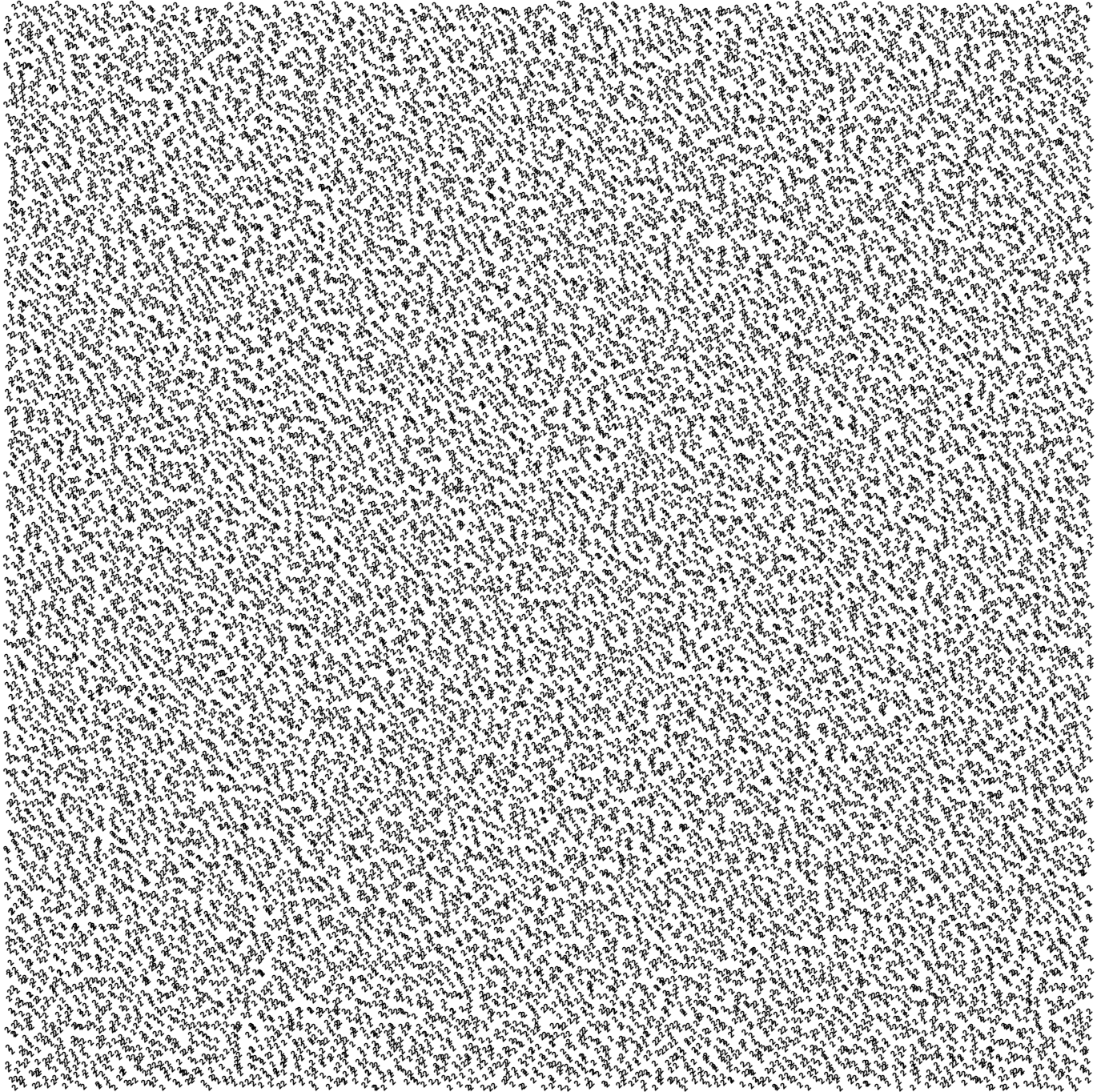

Figure **randtwo** from the Moiré Demonstration Kit
Accompanying the book: *The Theory of the Moiré Phenomenon*
by I. Amidror, published by Kluwer Academic Publishers, 2000.

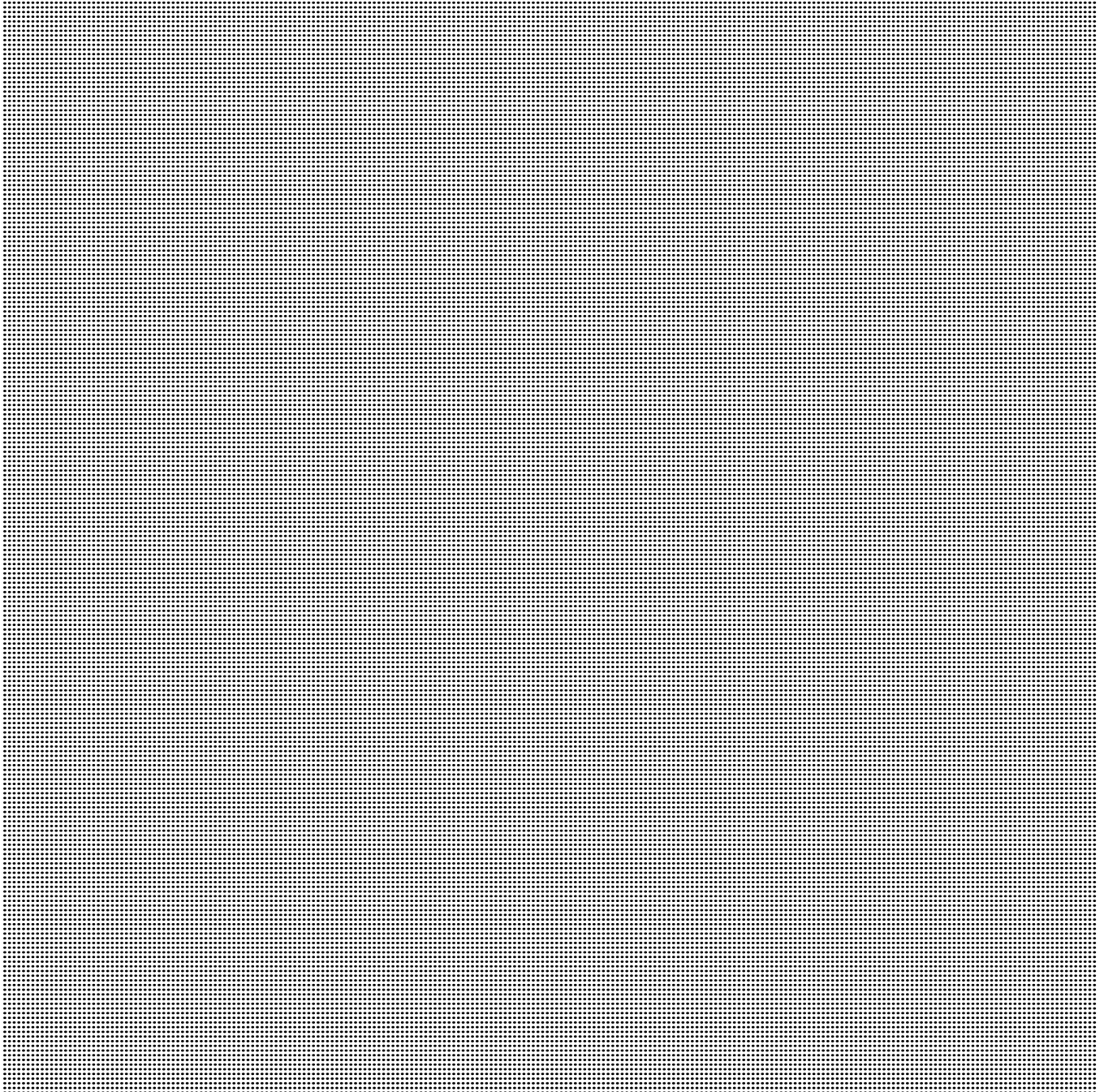

Figure **screen1** from the Moiré Demonstration Kit
accompanying the book: *The Theory of the Moiré Phenomenon*
by I. Amidror, published by Kluwer Academic Publishers, 1999.

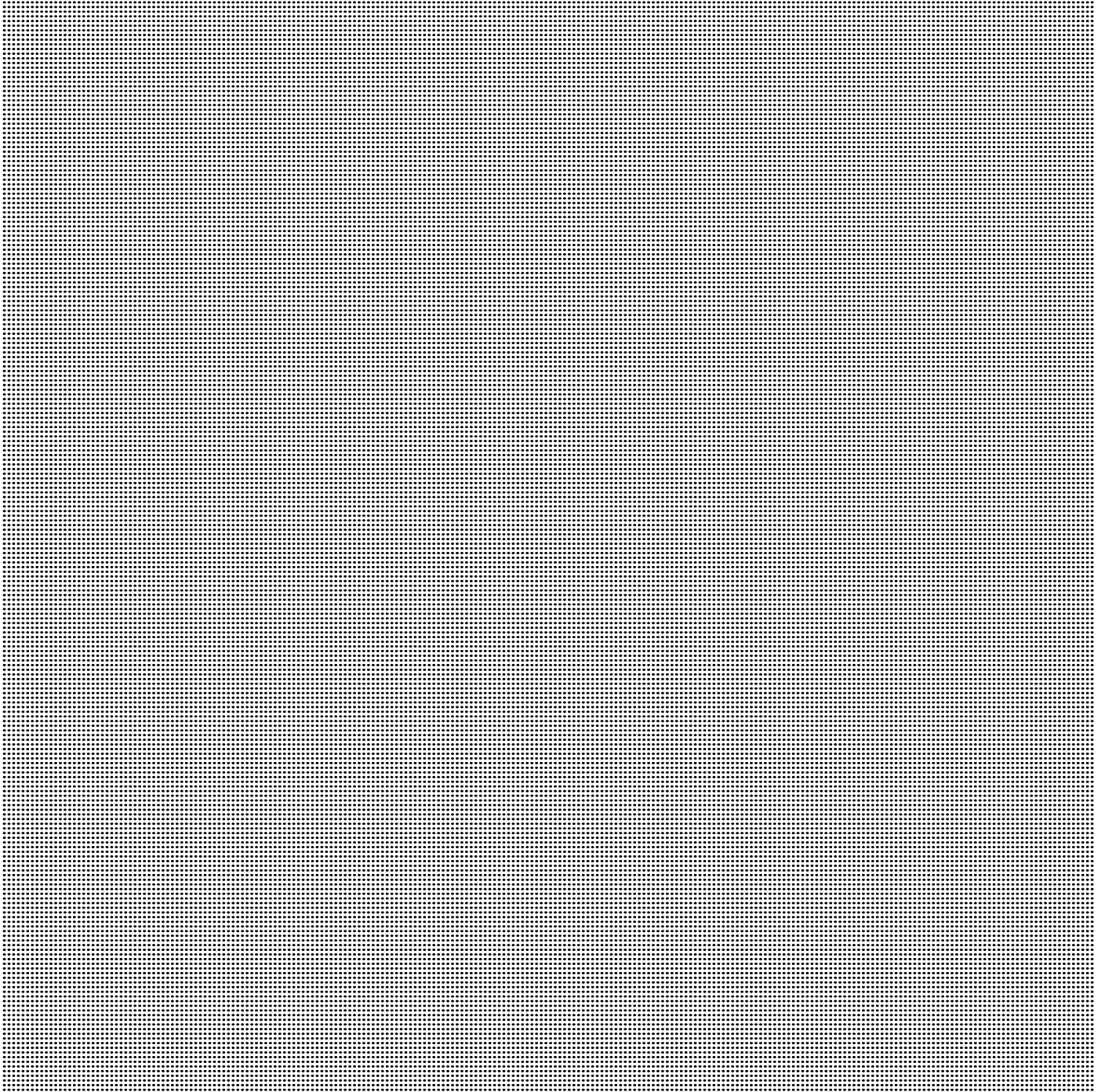

Figure **screen2** from the Moiré Demonstration Kit
accompanying the book: *The Theory of the Moiré Phenomenon*
by I. Amidror, published by Kluwer Academic Publishers, 1999.

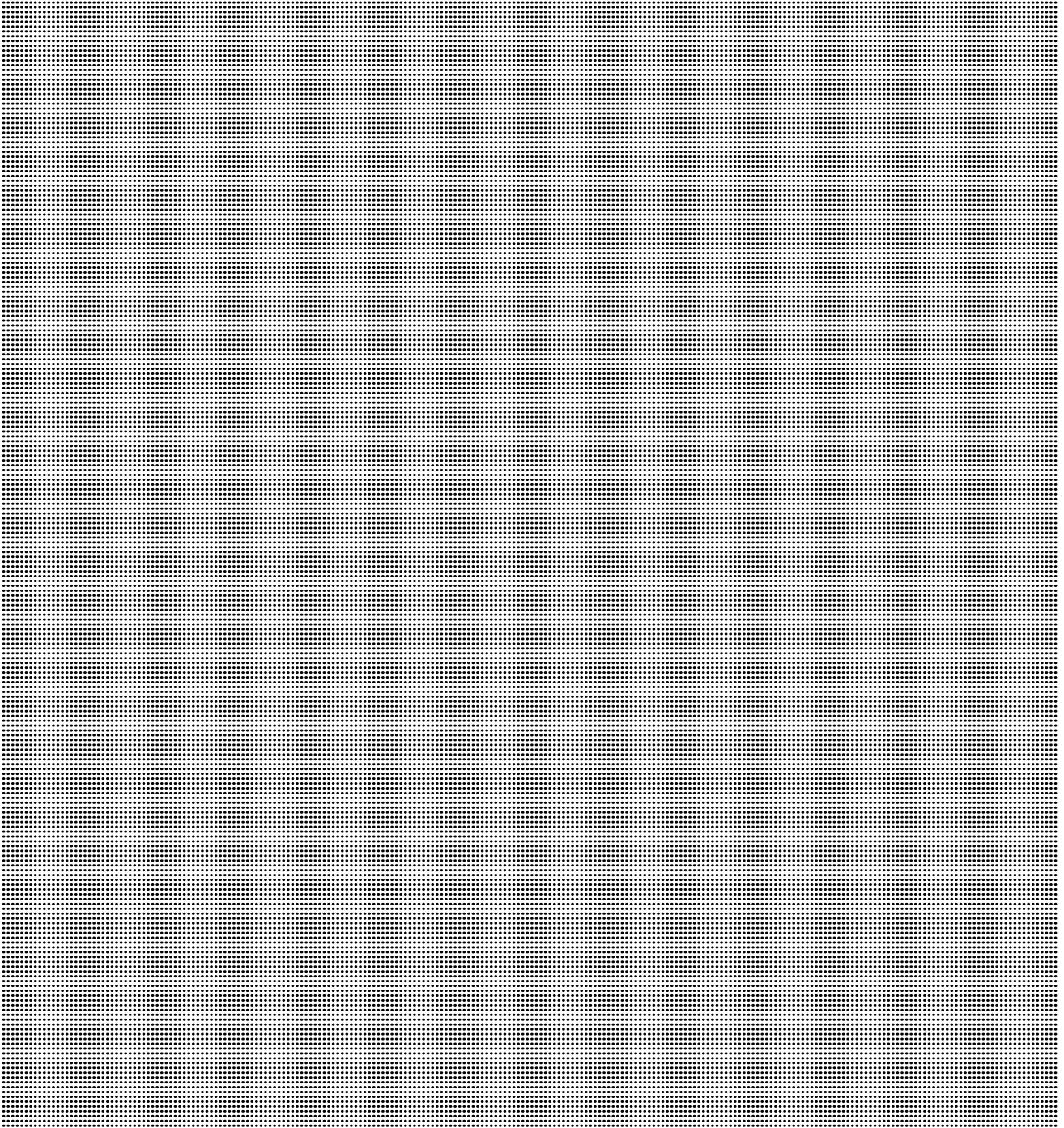

Figure **screen3** from the Moiré Demonstration Kit
accompanying the book: *The Theory of the Moiré Phenomenon*
by I. Amidror, published by Kluwer Academic Publishers, 1999.

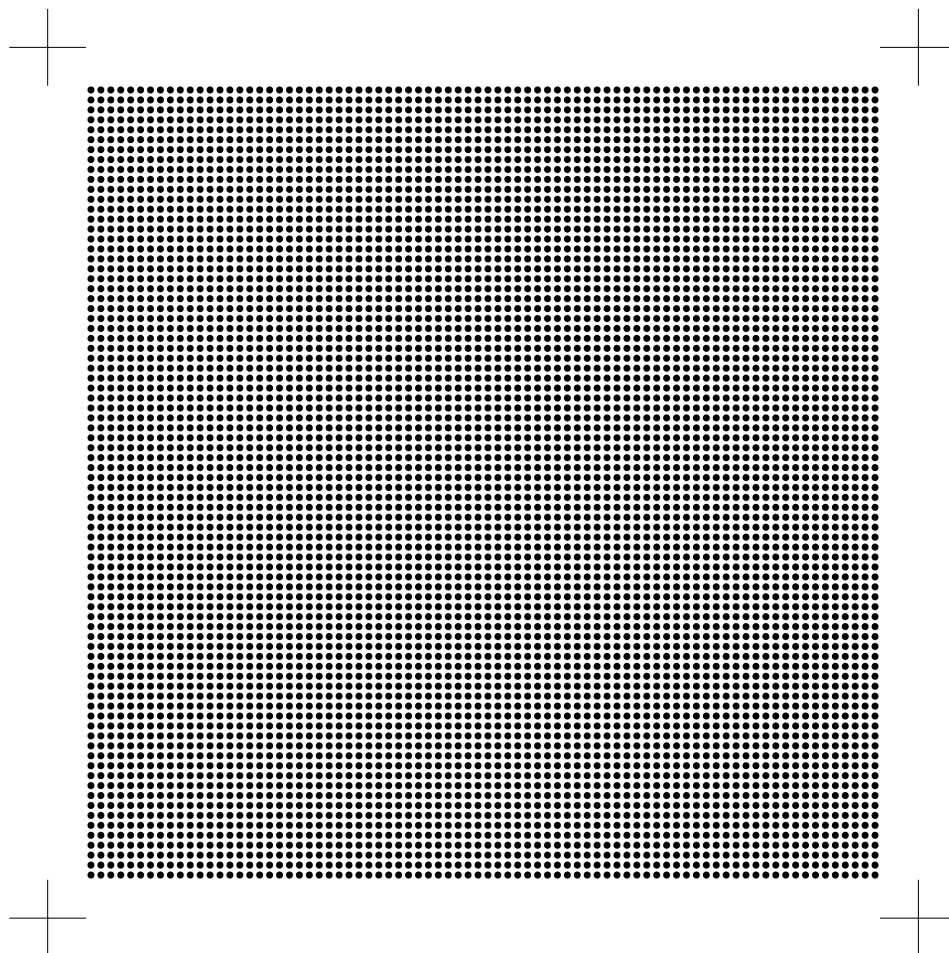

Figure **scnrcirc** from the Moiré Demonstration Kit accompanying the book: *The Theory of the Moiré Phenomenon* by I. Amidror, published by Kluwer Academic Publishers, 1999.

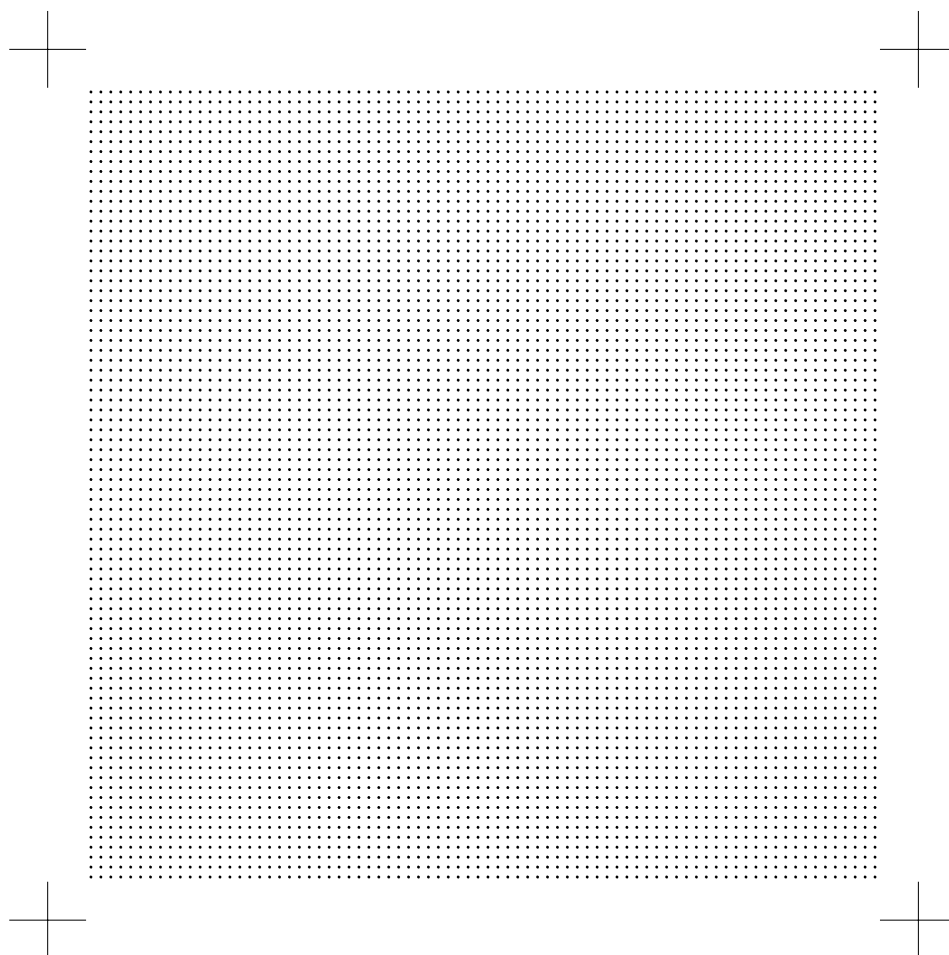

Figure **scrndot** from the Moiré Demonstration Kit
accompanying the book: *The Theory of the Moiré Phenomenon*
by I. Amidror, published by Kluwer Academic Publishers, 1999.

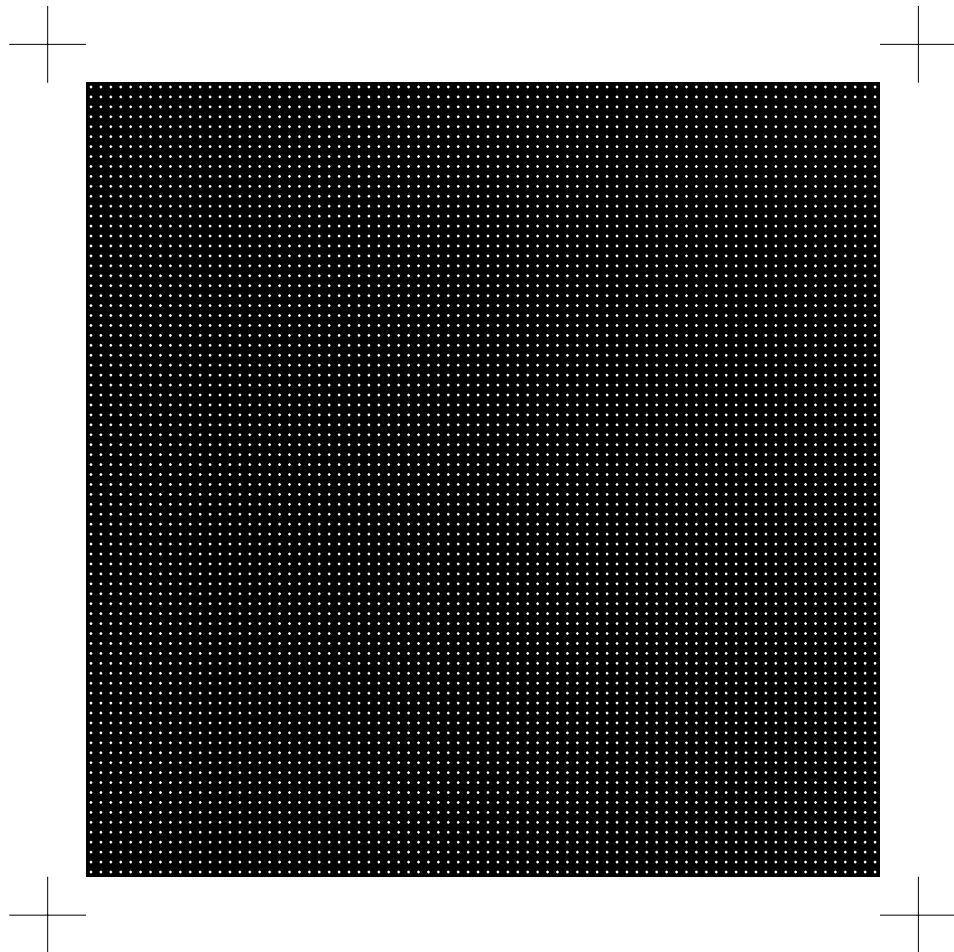

Figure **scrnhole** from the Moiré Demonstration Kit
accompanying the book: *The Theory of the Moiré Phenomenon*
by I. Amidror, published by Kluwer Academic Publishers, 1999.

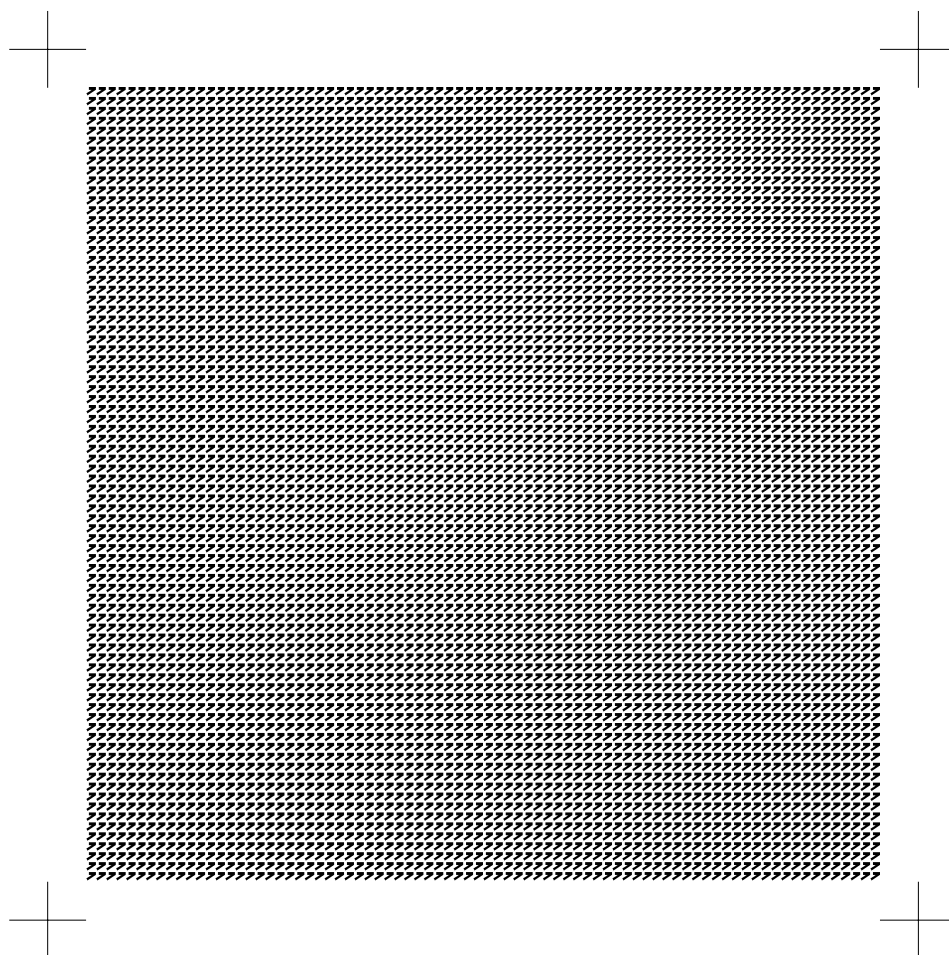

Figure **scrnone** from the Moiré Demonstration Kit accompanying the book: *The Theory of the Moiré Phenomenon* by I. Amidror, published by Kluwer Academic Publishers, 1999.

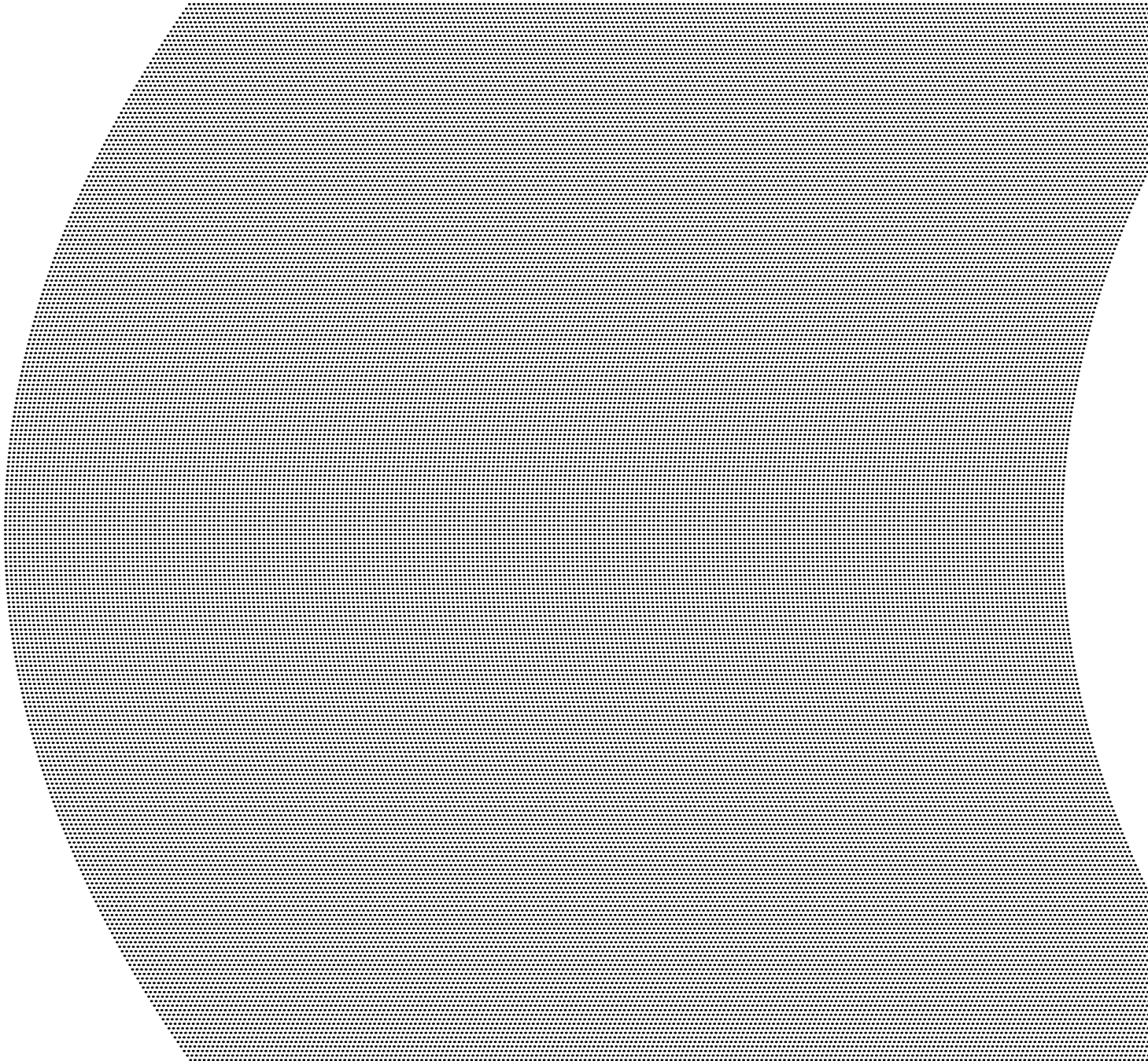

Figure **scrnpar** from the Moiré Demonstration Kit
accompanying the book: *The Theory of the Moiré Phenomenon*
by I. Amidror, published by Kluwer Academic Publishers, 2000.

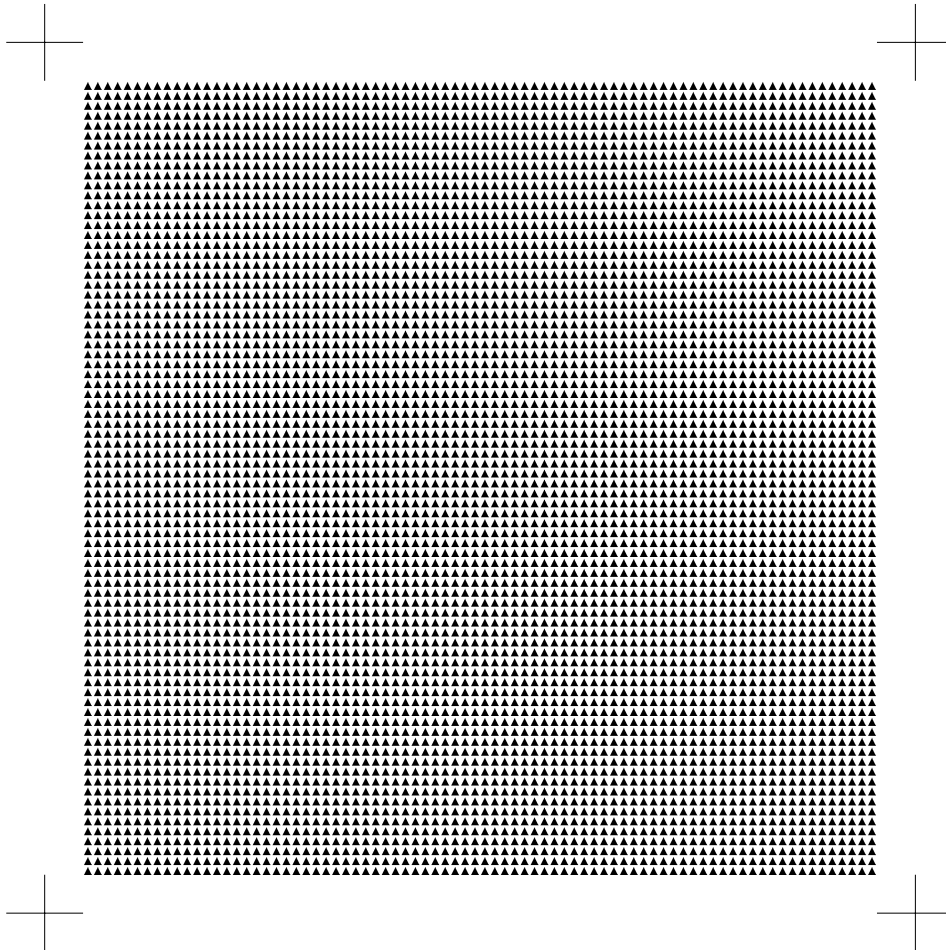

Figure **scrntri** from the Moiré Demonstration Kit
accompanying the book: *The Theory of the Moiré Phenomenon*
by I. Amidror, published by Kluwer Academic Publishers, 1999.

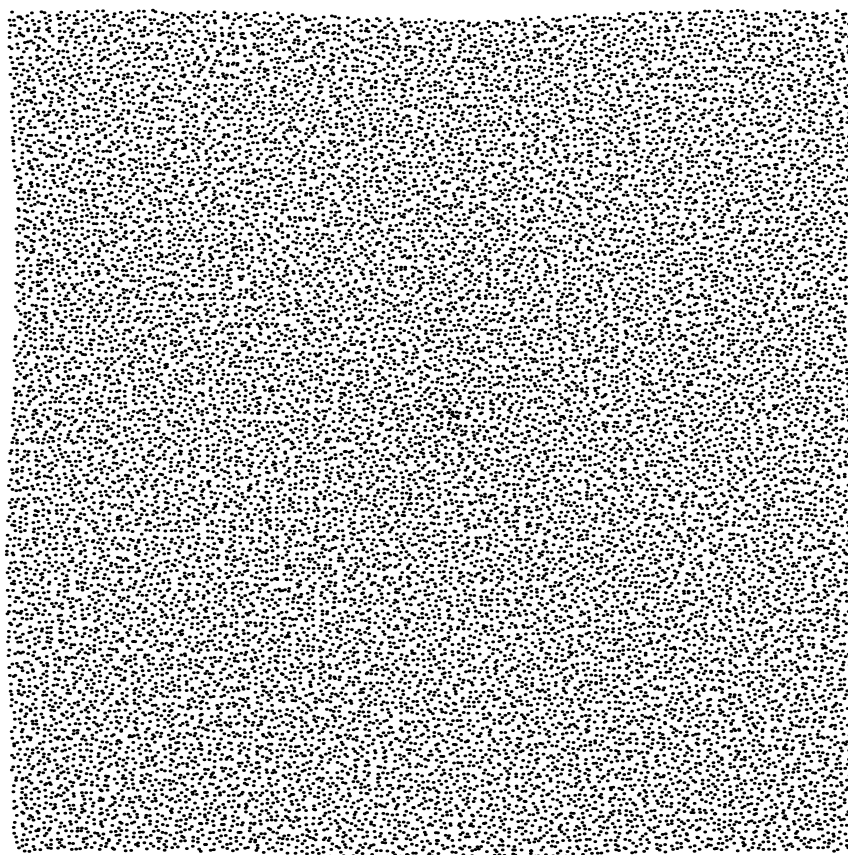

Figure **star1** from the Moiré Demonstration Kit
accompanying the book: *The Theory of the Moiré Phenomenon*
Vol. II: Aperiodic Layers, by I. Amidror, published by Springer, 2007.

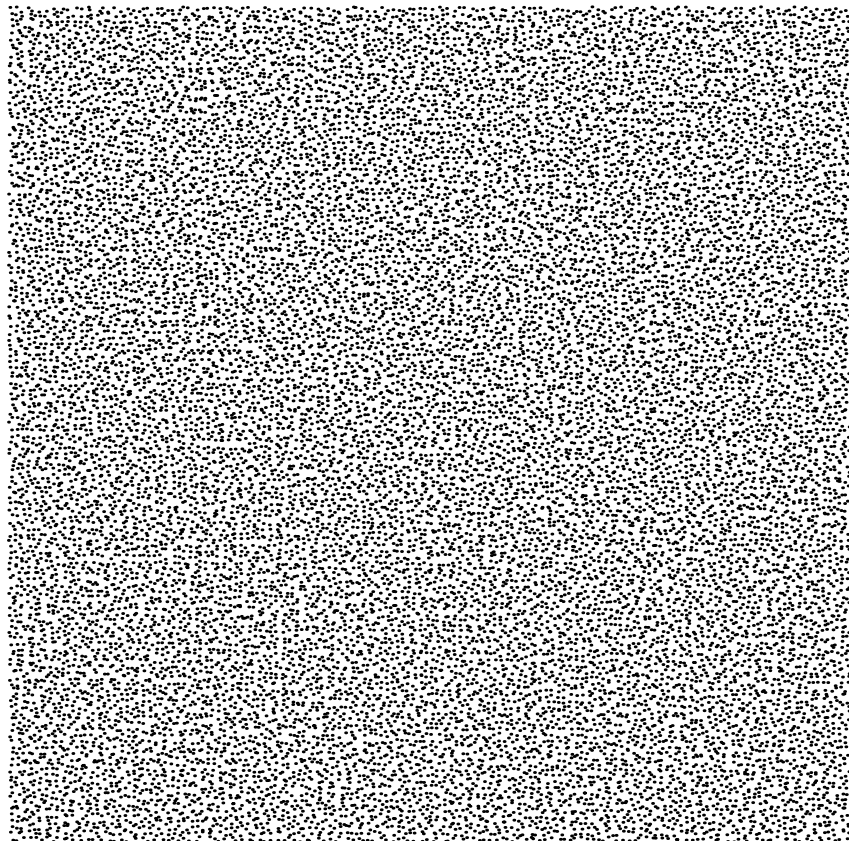

Figure **star2** from the Moiré Demonstration Kit
accompanying the book: *The Theory of the Moiré Phenomenon*
Vol. II: Aperiodic Layers, by I. Amidror, published by Springer, 2007.

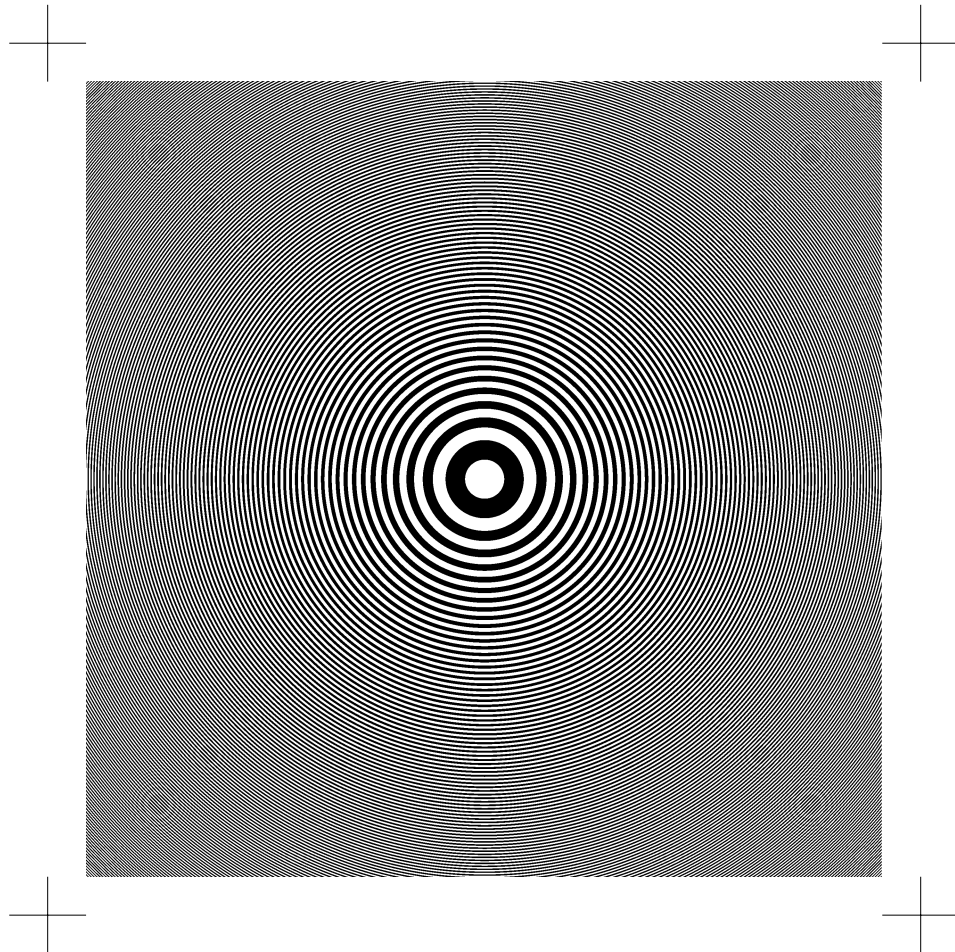

Figure **zone1** from the Moiré Demonstration Kit
accompanying the book: *The Theory of the Moiré Phenomenon*
by I. Amidror, published by Kluwer Academic Publishers, 1999.

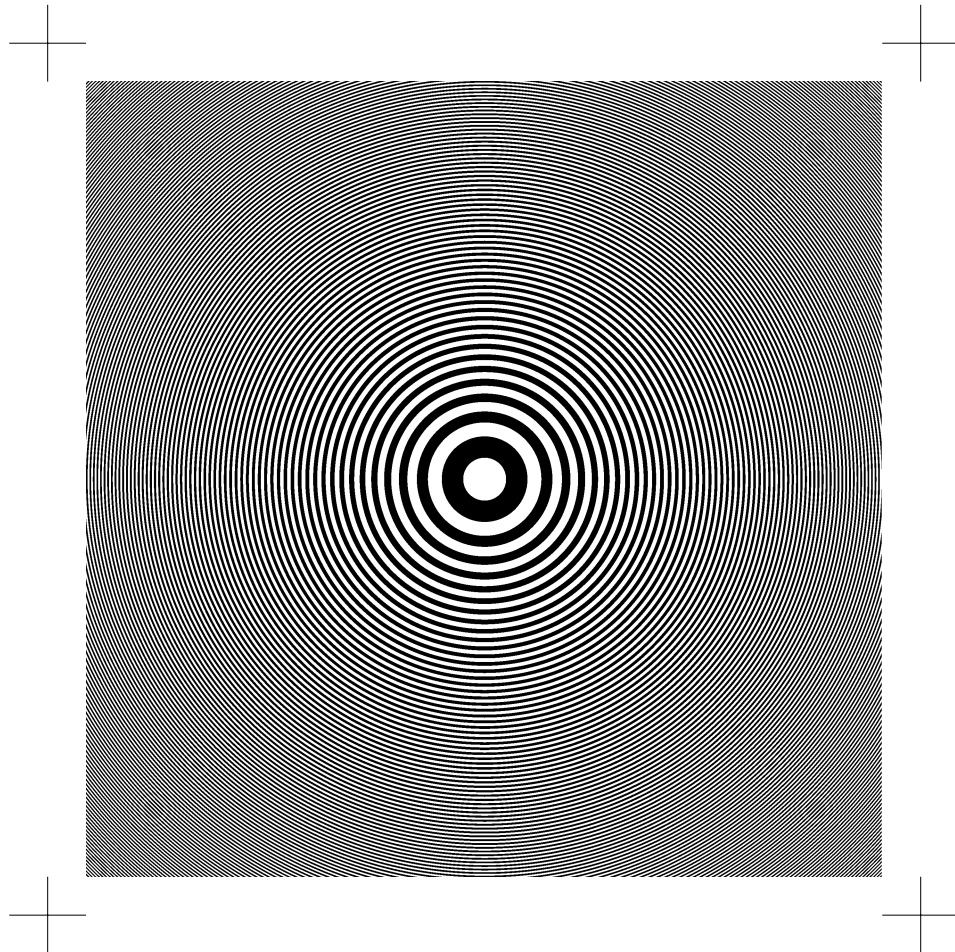

Figure **zone2** from the Moiré Demonstration Kit
accompanying the book: *The Theory of the Moiré Phenomenon*
by I. Amidror, published by Kluwer Academic Publishers, 1999.